

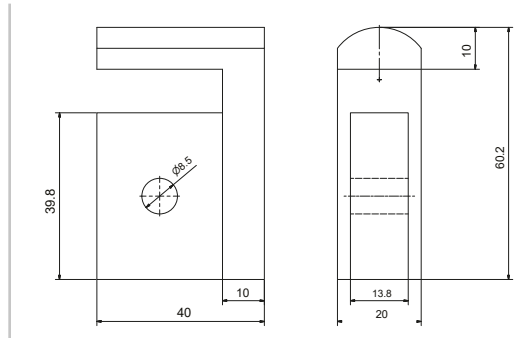





**Sistema** *Ulisse*

Materiale: Acciaio Zincato



-  *End plate support for Ulisse System*
-  *Raccordement de support pour Ulisse System*
-  *Terminal de apoyo para Ulisse System*
-  *Опорный зажим*
-  *Unterstützungsendstück für Systeme Ulisse*

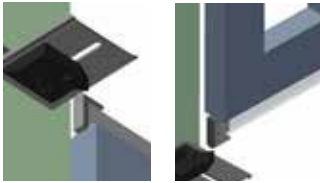

Art.	Peso/g	Imb.
-	Weight(g)	Packaging
<b>861</b>	250	4