



NOVA-FERR srl

**SOLUZIONI E ACCESSORI
PER CHIUSURE TECNICHE**



Distribuito da:

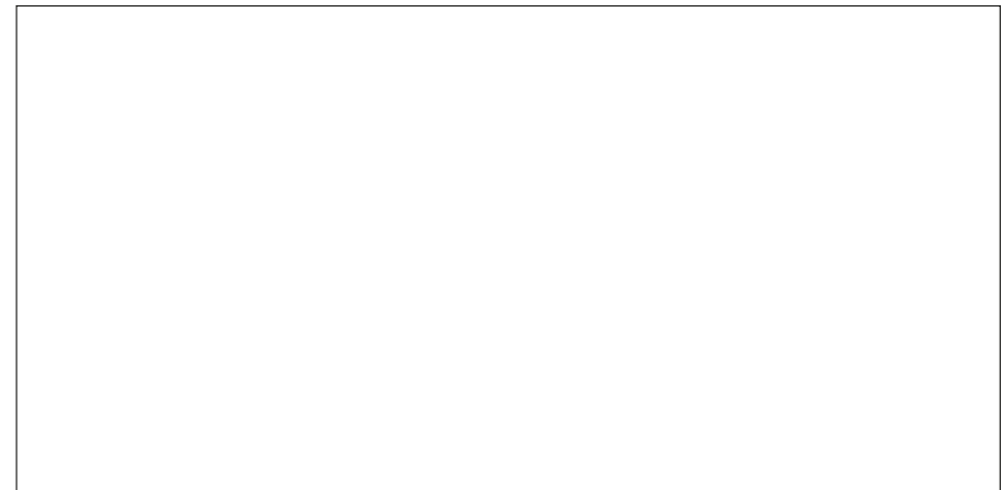

NF NOVA-FERR srl

10070 Grosso (TO) - Località Vauda 12
Tel. +39 (0)11 92 68 262 - Fax +39 (0)11 92 60 009
www.novaferr.com - info@novaferr.com

La Garanzia del
PRODOTTO made in **ITALY**

NOVAGUIDE

www.novaferr.com



La Nova-Ferr S.r.l. di Grosso Canavese (To) fondata nel 1980 è un'azienda specializzata a livello nazionale e internazionale nella progettazione e produzione di accessori per ferramenta, accessori per serramenti in genere e chiusure industriali. Fornisce una vasta gamma di articoli per il settore delle costruzioni in carpenteria metallica, siderurgico e meccanico. L'attenzione per la qualità del prodotto e del servizio rivolto alla clientela è stata perseguita con l'adozione di un sistema di qualità conforme alla UNI EN ISO 9001:2008.

Nova-Ferr S.r.l. in Grosso Canavese – Turin – founded in 1980, is a Company nationally and internationally specialized in the design and production of accessories for ironmongery, doors, windows, shutters and industrial doors. Nova-Ferr Srl. supply a wide range of items suitable for mechanical, steel, iron and metal structural construction field. Attention to quality and service of product supplied to clients has been followed adopting a quality system according to UNI EN ISO 9001:2008.

Nova Ferr Srl, situé à Grosso Cavanese- Turin- fondée en 1980, est une société spécialisée, à un niveau national et international, dans l'étude et la production d'accessoires de quincaillerie de fermetures, et d'accessoires de portails industriels. Une vaste gamme d'articles est disponible, pour le secteur de la construction métallique, de la menuiserie bois, et de la menuiserie métallique. L'attention pour la qualité des produits et du service à la clientèle, a été suivie, en adoptant un système de contrôle de qualité conforme à la norme UNI EN ISO 9001:2008.

Nova-Ferr Srl situada en Grosso Canavese (TO), fundada en 1980 es una empresa especializada a nivel nacional e internacional en proyectar y producir accesorios para las ferreterías, herrajes en general e industriales. Propone una vasta gama de artículos para el sector de la construcción metálica, siderúrgica y mecánica. La atención por la calidad del producto y por el servicio ofrecido al cliente son garantías del proceso de un sistema activo de calidad conforme a la UNI EN ISO 9001/2008.

Предприятие Nova-Ferr S.r.l., расположенное в Гроссо Канавезе (пров. Турина), основано в 1980 г. и специализируется на разработке и производстве широкой гаммы деталей и комплектующих для оконных и дверных проемов, в том числе для производственных помещений. Система качества, внедренная на производстве, отвечает самым строгим требованиям норматива UNI EN ISO 9001:2000.



Contatti | Contact | Contacts
Contactos | Координаты операторов

info@novaferr.com

export@novaferr.com

www.novaferr.com

CANCELLO A BATTENTE

SWING GATE
PORTAIL À BATTANT
PUERTA CANCELA
РАСПАШНЫЕ ВОРОТА

pag 3

CANCELLO SCORREVOLE

SLIDING GATE
PORTAIL COULISSANT
PUERTA CORREDERA
СДВИЖНЫЕ(ОТКАТНЫЕ) ВОРОТА

pag 5

CANTILEVER

CANTILEVER SYSTEM
SYSTÈME CANTILEVER
SISTEMA CANTILEVER
ОТКАТНЫЕ ВОРОТА КОНСОЛЬНОГО ТИПА

pag 7

SISTEMA ULISSE

ULISSE SYSTEM
SYSTÈME ULISSE
SISTEMA ULISSE
СИСТЕМА ULISSE

pag 9

PORTONE A LIBRO 2+2

FOLDING DOOR 2+2
PORTE PLIANTE 2+2
PORTÓN PLEGABLE 2+2
СКЛАДЧАТЫЕ ВОРОТА 2+2

pag 11

PORTONE A LIBRO SINGOLA PARTITA

SINGLE FOLDING DOOR
PORTE PLIANTE UNIQUE
PORTÓN PLEGABLE SOLO
СКЛАДЧАТЫЕ ВОРОТА С ОДНОСТОРОННИМ ОТКРЫТИЕМ

pag 13

PORTONE A LIBRO DOPPIA PARTITA

DOUBLE FOLDING DOOR
PORTE PLIANTE DOUBLE
PORTÓN PLEGABLE DOBLE
СКЛАДЧАТЫЕ ВОРОТА С ДВОЙНЫМ ОТКРЫТИЕМ

pag 15

PORTONE SCORREVOLE APPESO

HANGING SLIDING DOOR
PORTE COULISSANTE SUSPENDUE
PORTÓN PLEGABLE COLGADO
ПОДВЕСНЫЕ ПРОМЫШЛЕННЫЕ ВОРОТА

pag 17

PORTONE SCORREVOLE SU RUOTE

ON WHEEL SLIDING DOOR
PORTE COULISSANTE SUSPENDUE
PORTÓN PLEGABLE EN RUEDAS
ОТКАТНЫЕ ПРОМЫШЛЕННЫЕ ВОРОТА

pag 19

PARETI DIVISORIE E RIVESTIMENTI

PARTITIONS AND COATINGS
CLOISONS ET REVÊTEMENTS
PARTICIONES Y RECUBRIMIENTOS
ПЕРЕГОРОДКИ И ОБЛИЦОВОЧНЫЕ МАТЕРИАЛЫ

pag 21

SQUADRETTE E SISTEMI DI FISSAGGIO PANNELLI

FIXING SYSTEMS
SYSTÈMES DE FIXATION
SISTEMAS DE FIJADO
КРЕПЕЖНЫЕ ЭЛЕМЕНТЫ И СИСТЕМЫ ФИКСАЦИИ ПАНЕЛЕЙ

pag 23

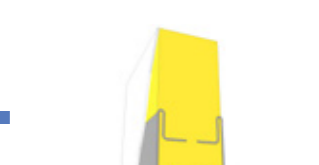
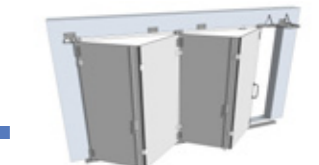
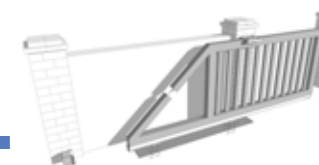
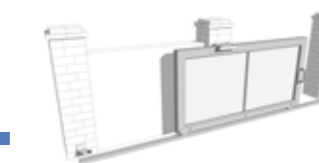

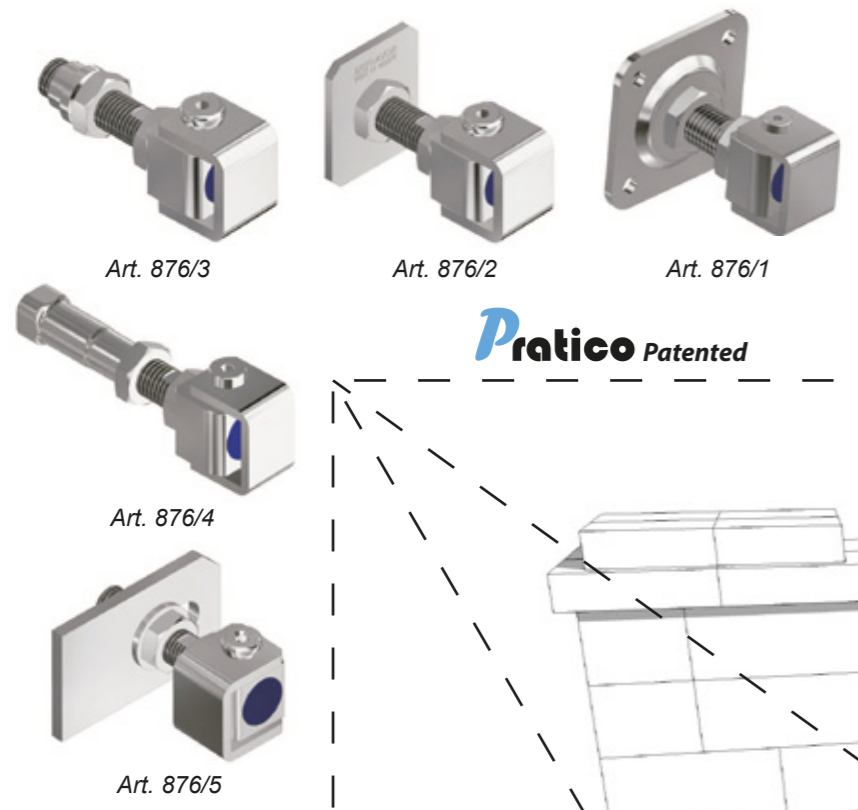

Pratico Patented



Link Patented

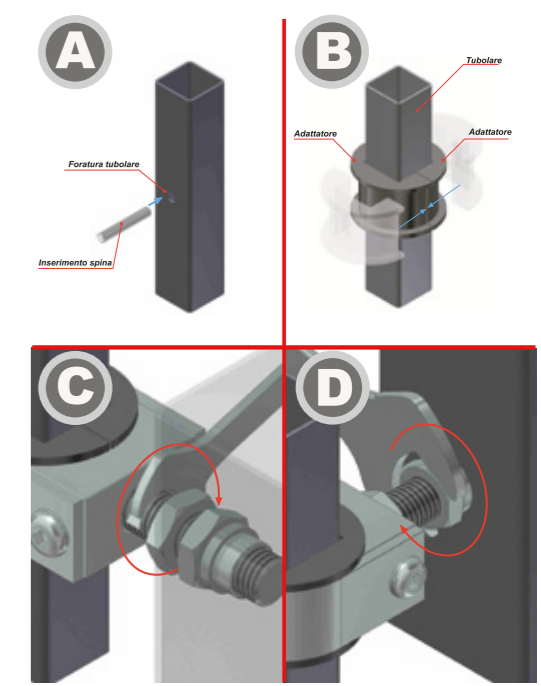
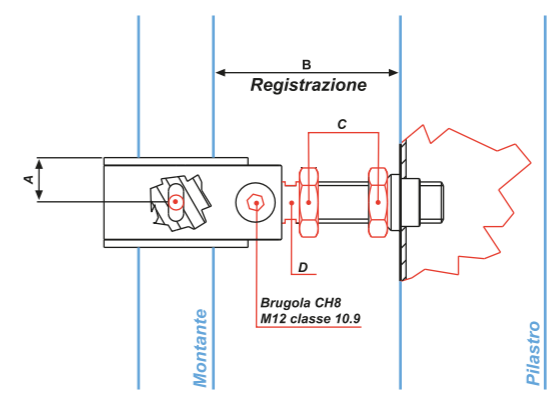
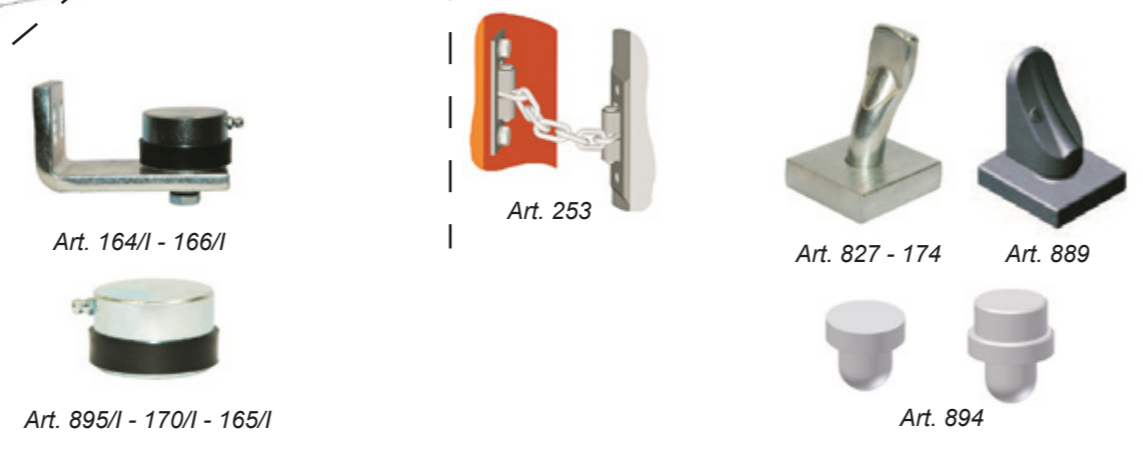
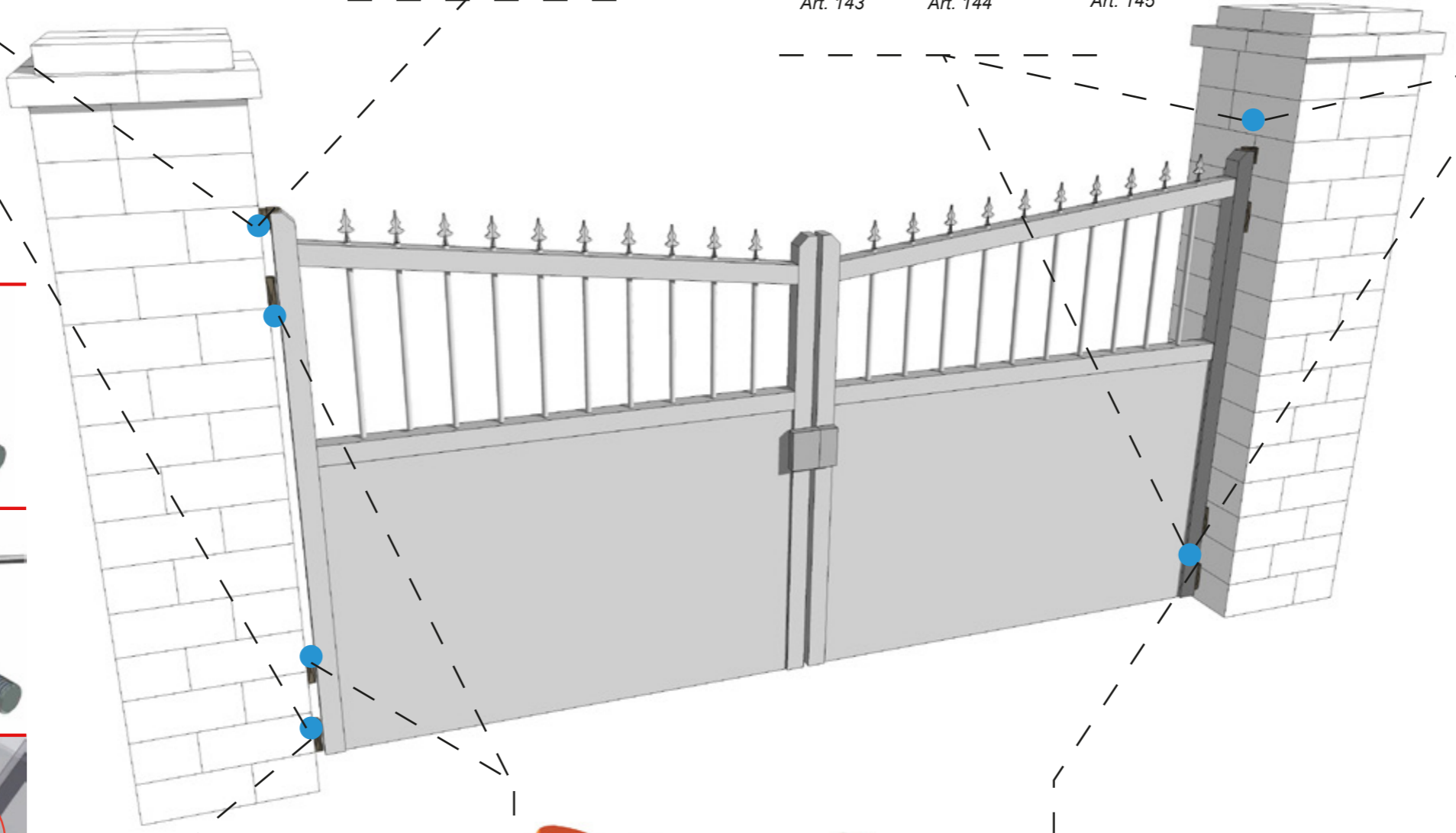
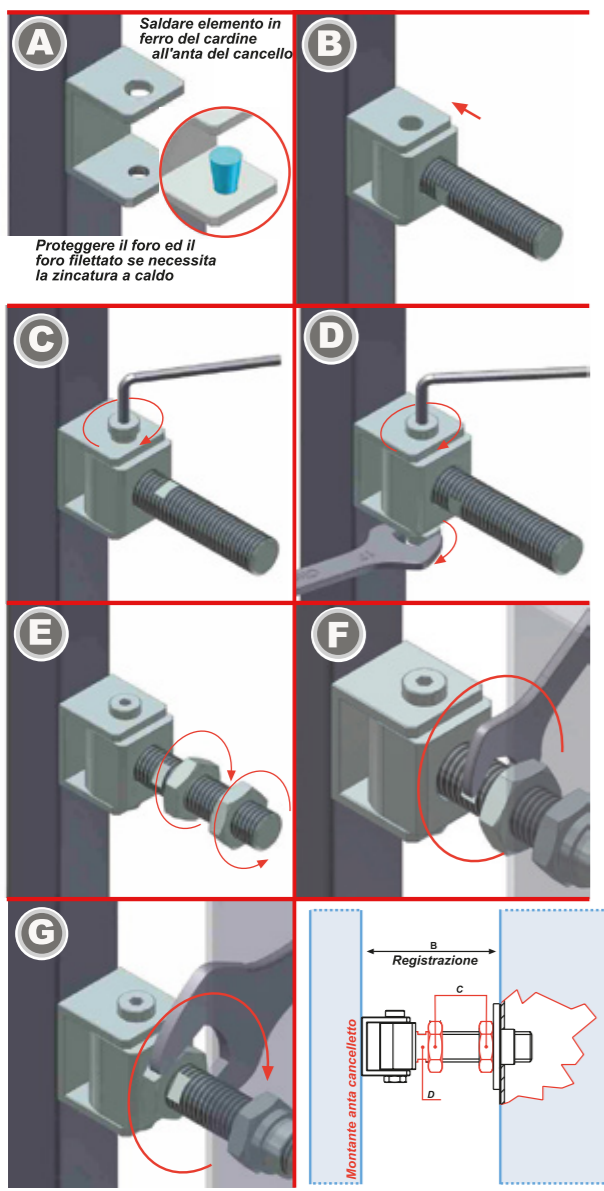

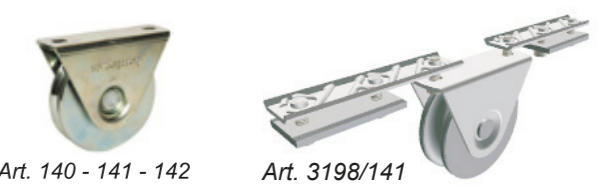
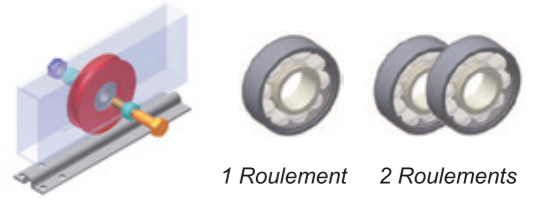
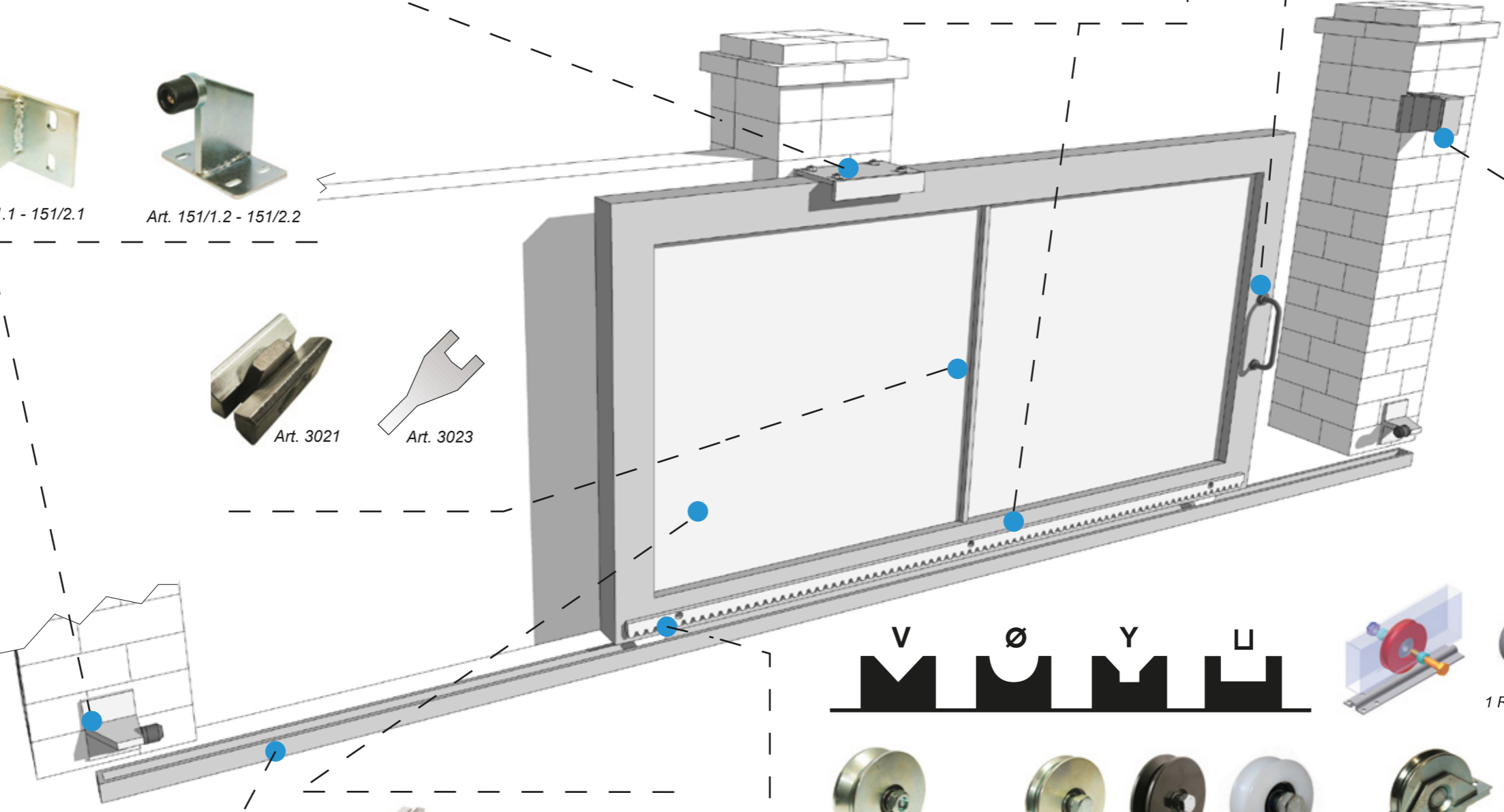
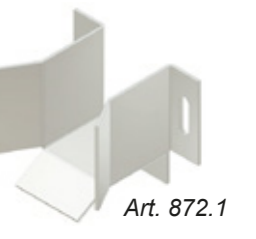
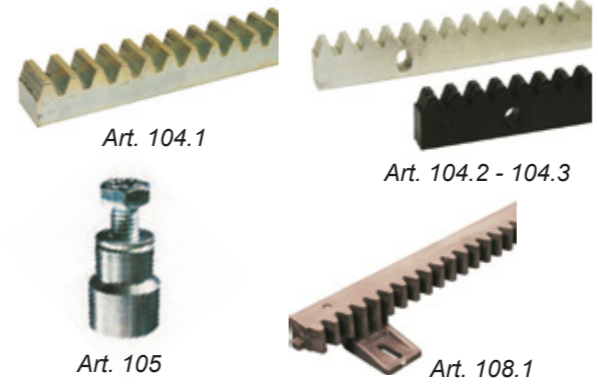
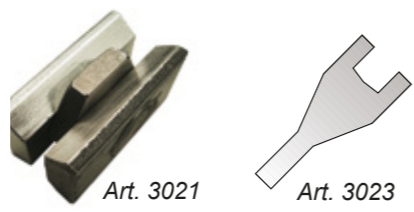
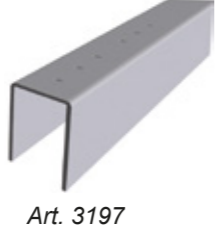
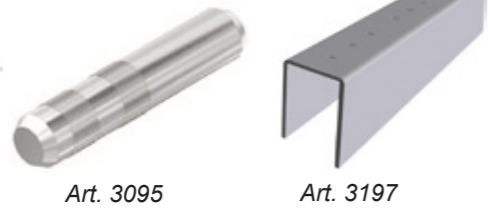

AUTO PORTANT

Gate System

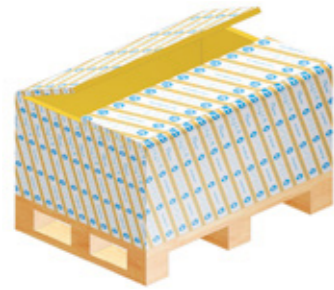

Basic Kit
450Kg - L= 4000mm

Medium Kit
600Kg - L= 10000mm

Magnum Kit
1200Kg - L= 15000mm

Aluminium Kit
400Kg - L= 8000mm



Art. 162



Art. 153/4 - 153/5

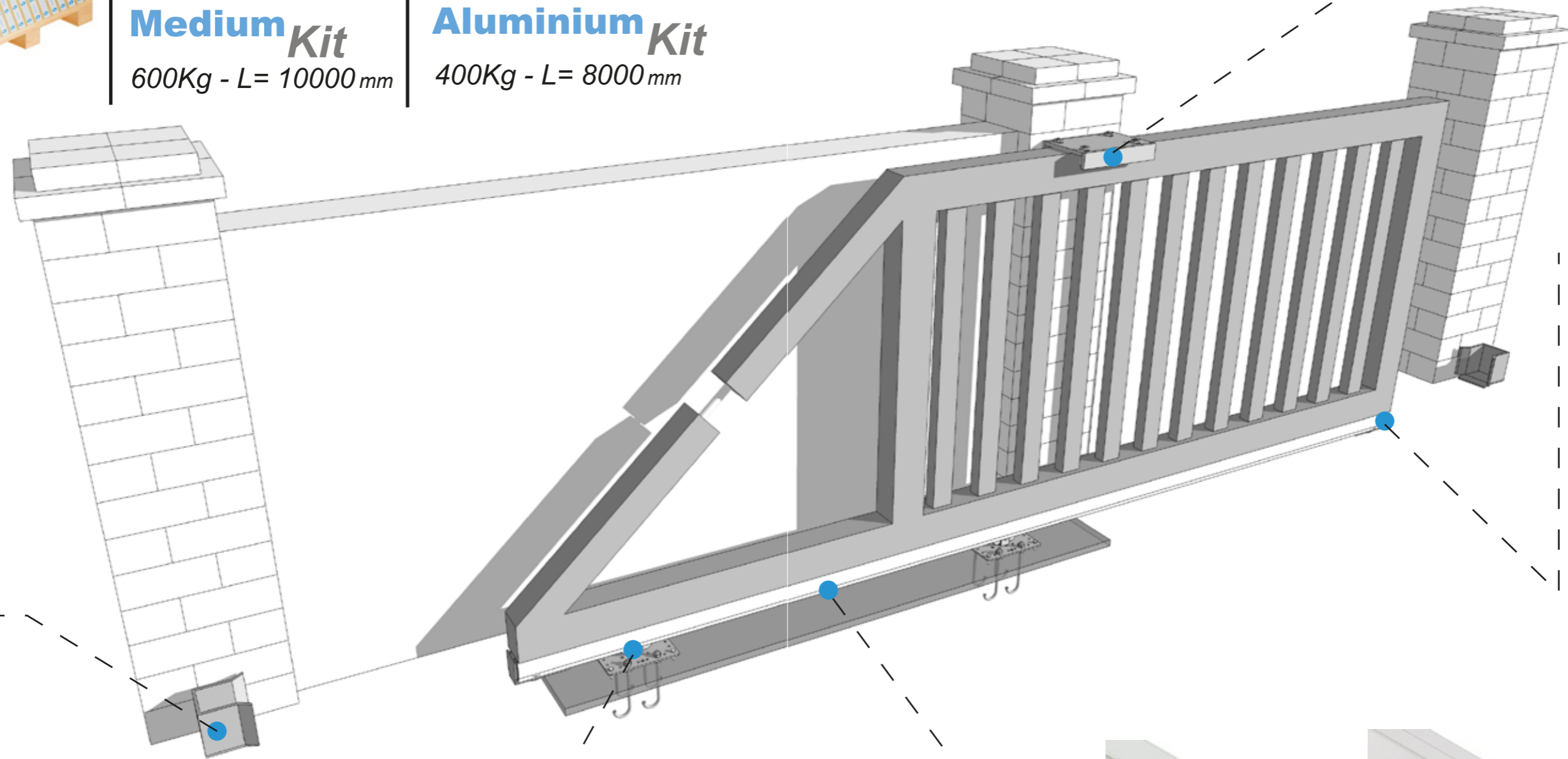

Art. 852



Art. 852/4

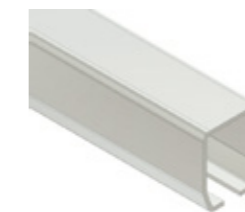

Art. 857



Art. 859



Art. 850



Art. 850/4



Art. 851



Art. 853

Ulisse System

Max L= 4500 / 300Kg



Art. 3090

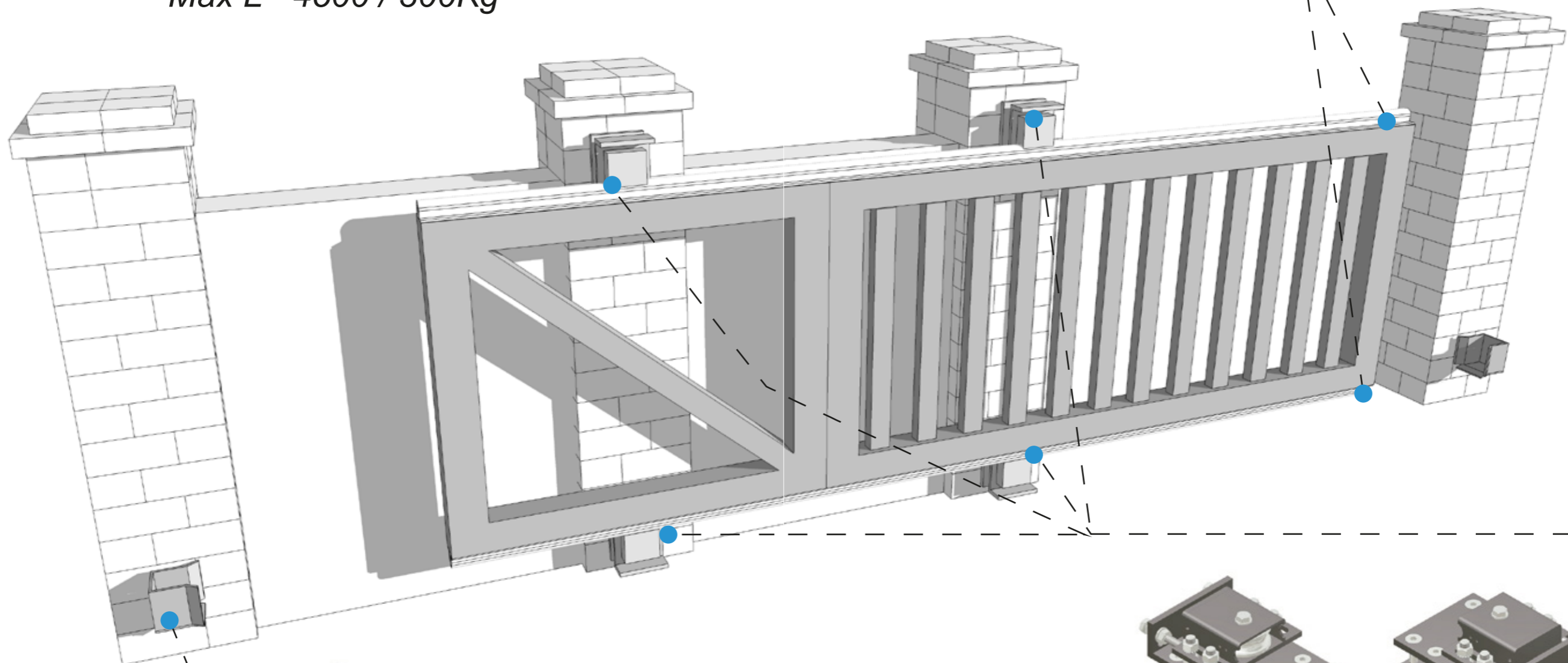

Art. 854

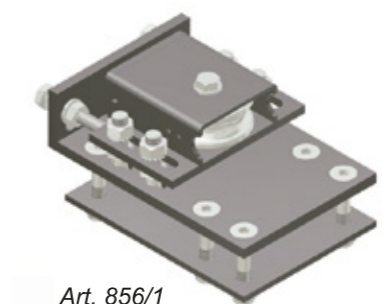

Art. 856/1

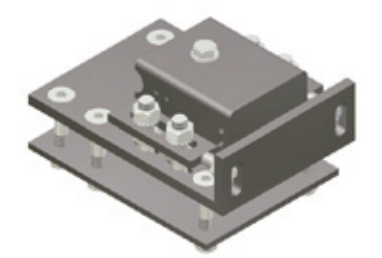

Art. 856/2



Art. 3088



Art. 50



Art. 3004



Art. 3084.1
Art. 3084.2
Art. 3084.3



Art. 3003.1



Art. 3051



Art. 3904.1



Art. 3906



Art. 3908



Art. 3922



Art. 3187

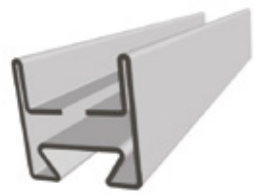

Art. 3186



Art. 3981



Art. 3050/1.2



Art. 3053



Art. 3952



Art. 3976



Art. 3990.3



Art. 3991

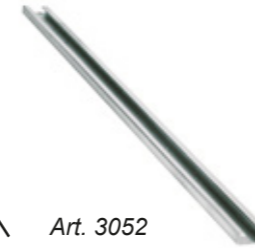

Art. 3052



Art. 3650



Art. 3980



Art. 3984



Art. 3353/1



Art. 124



Art. 125



Art. 3975

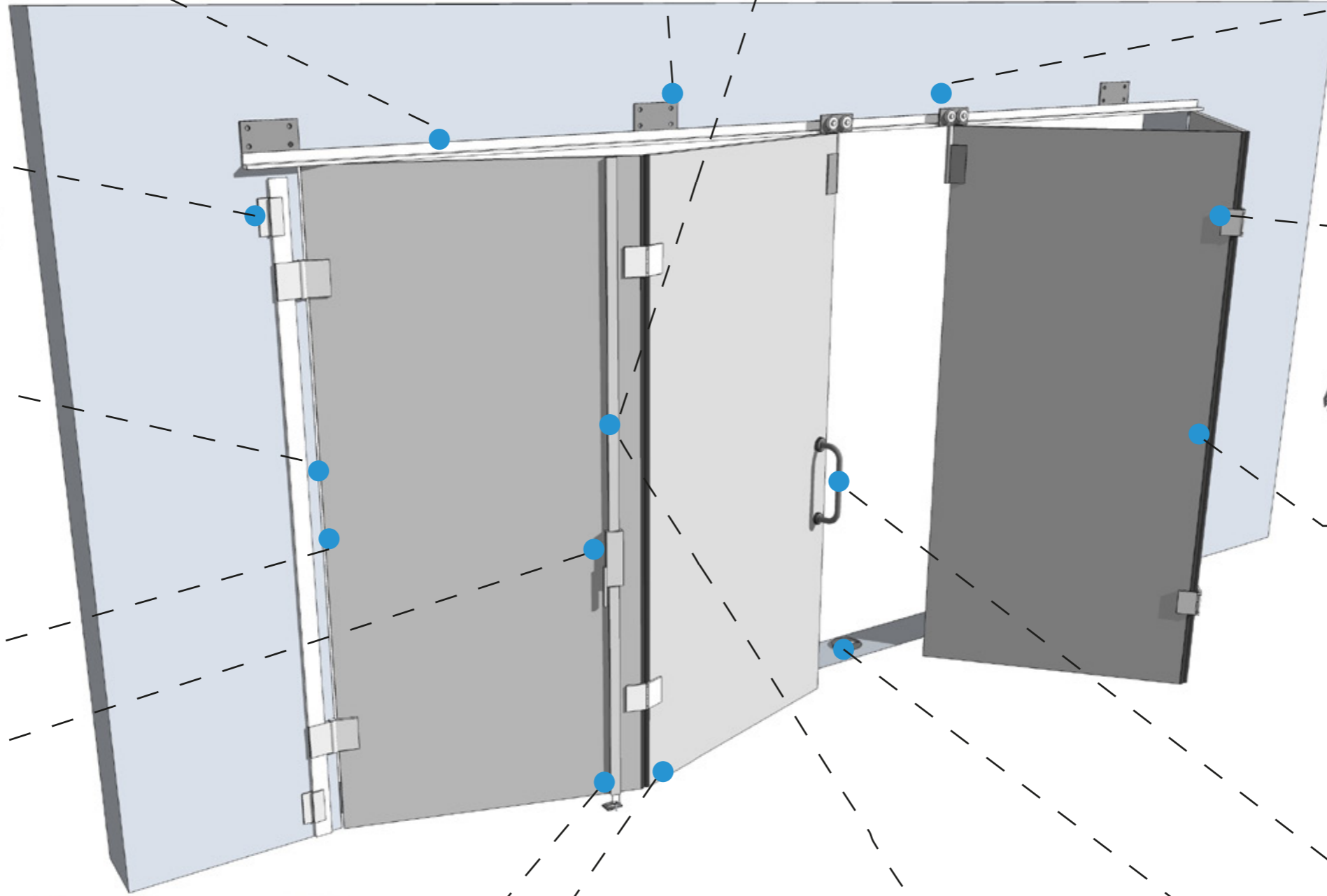

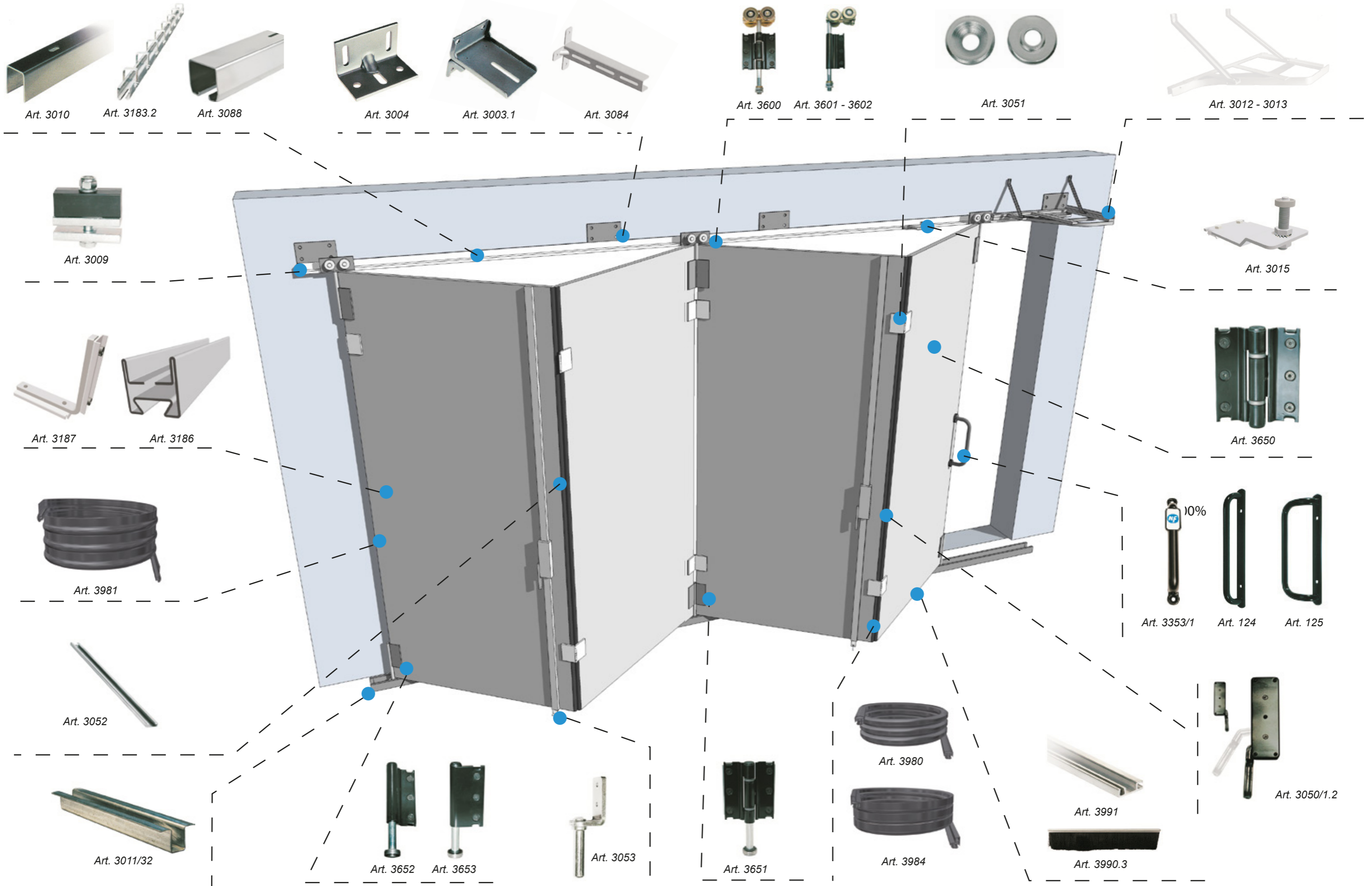

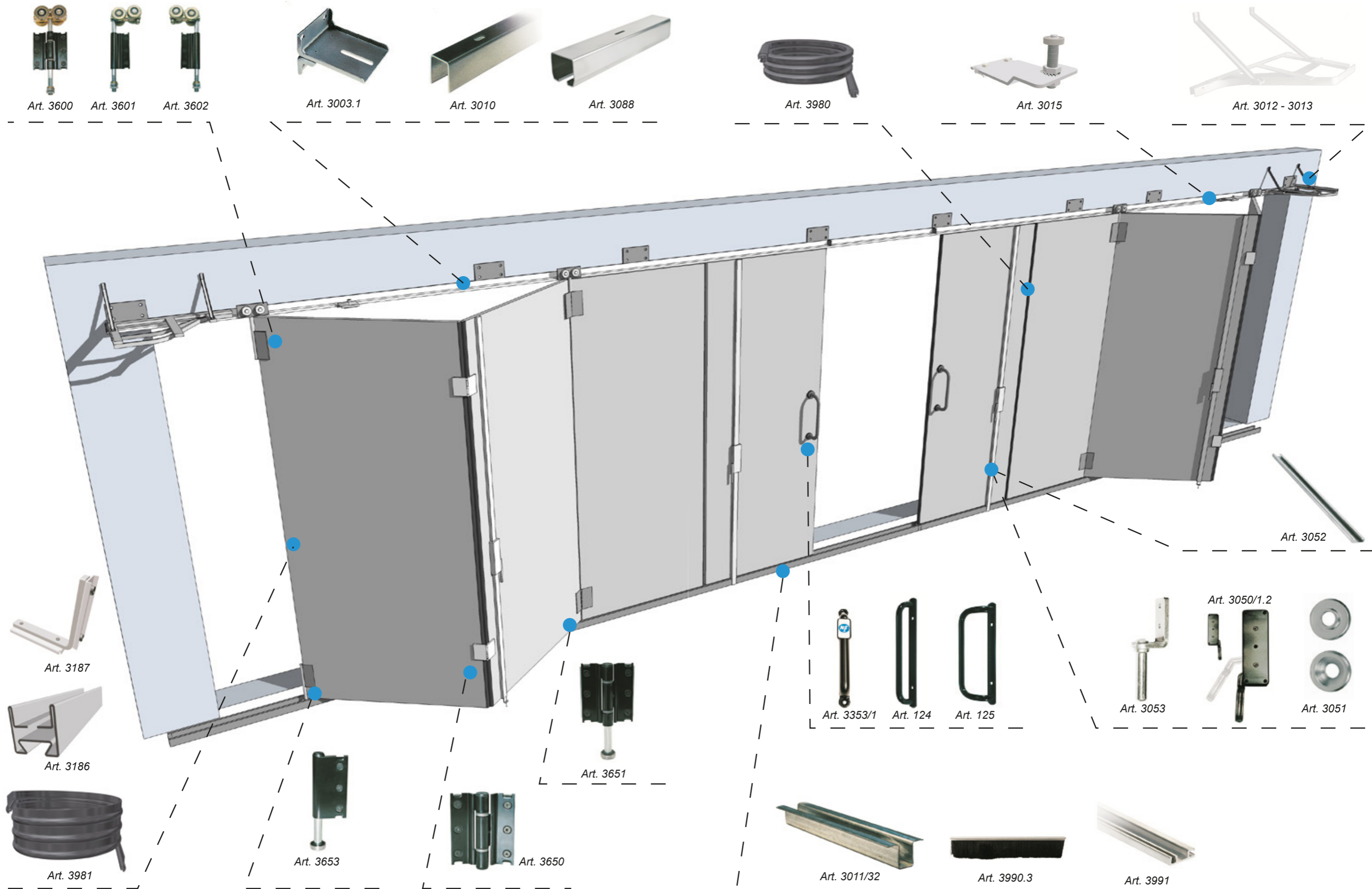

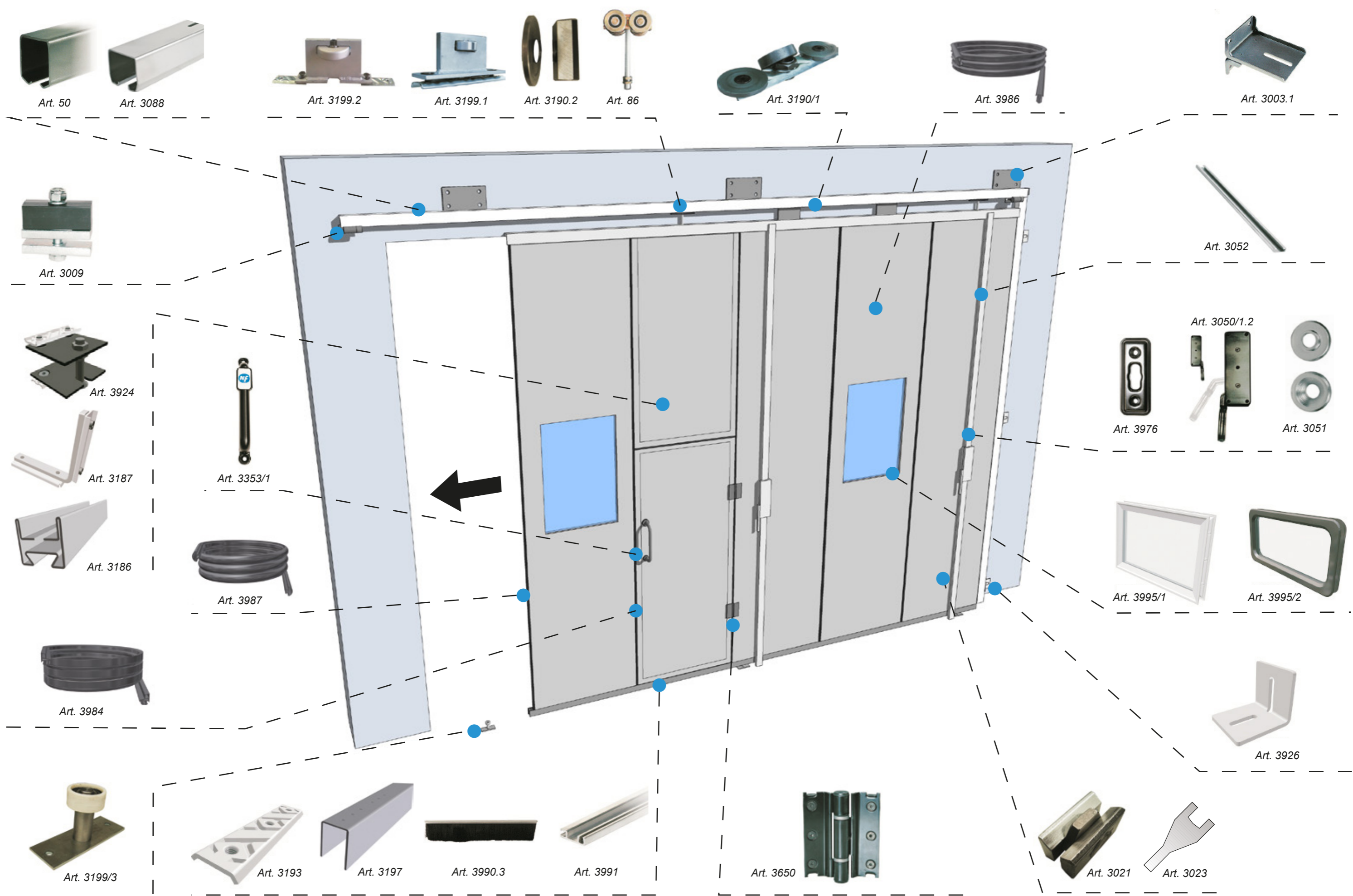

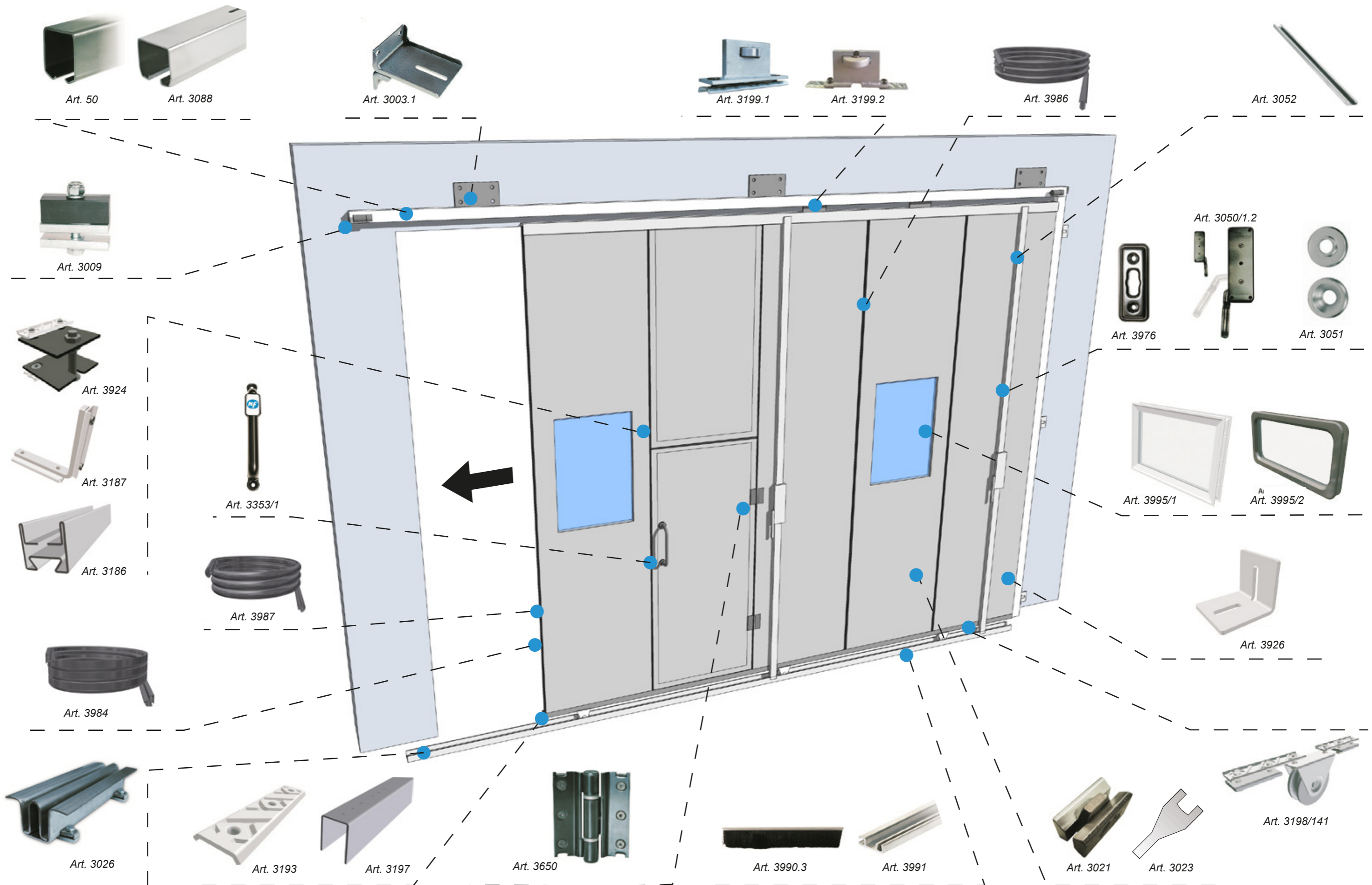

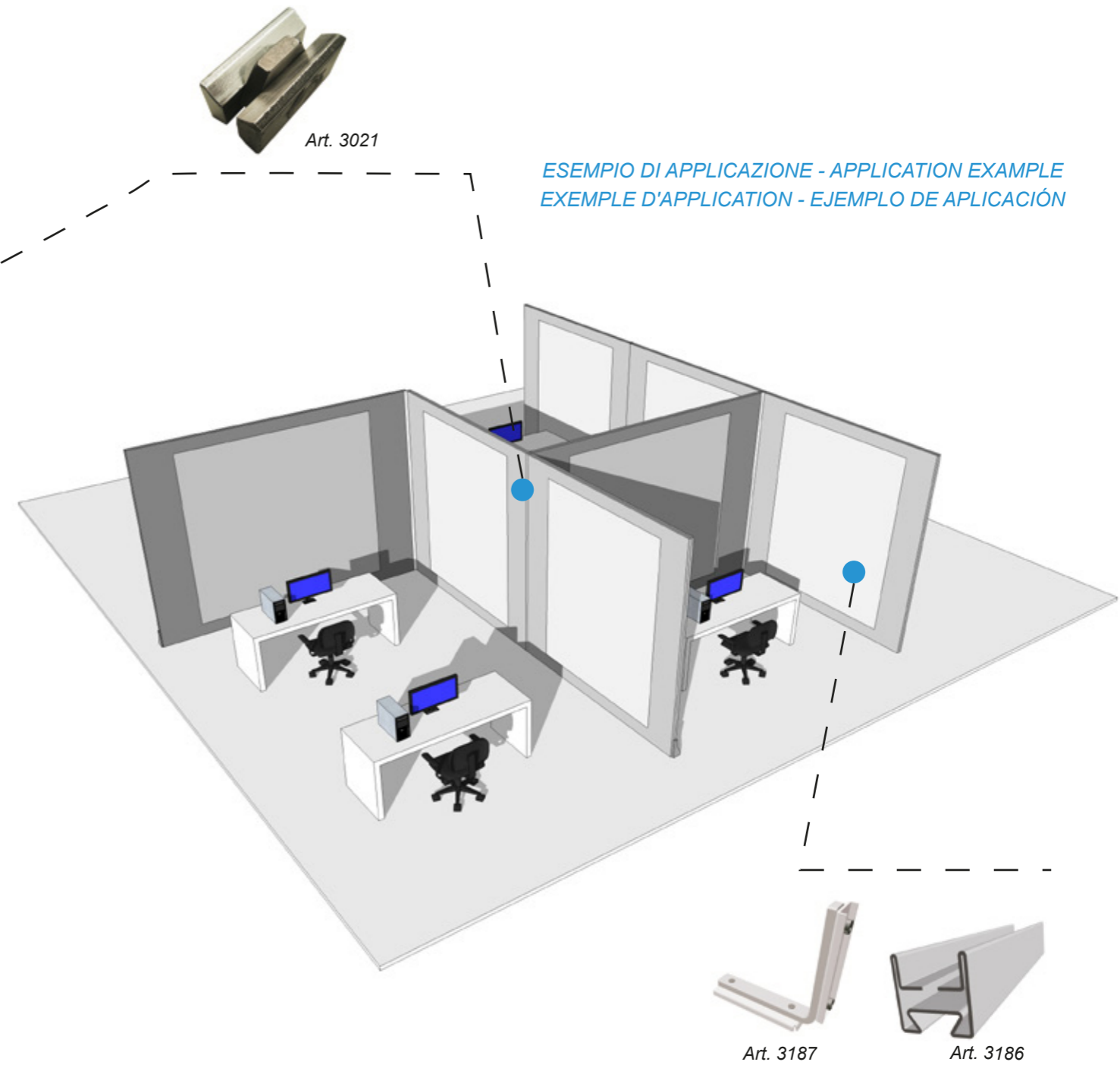
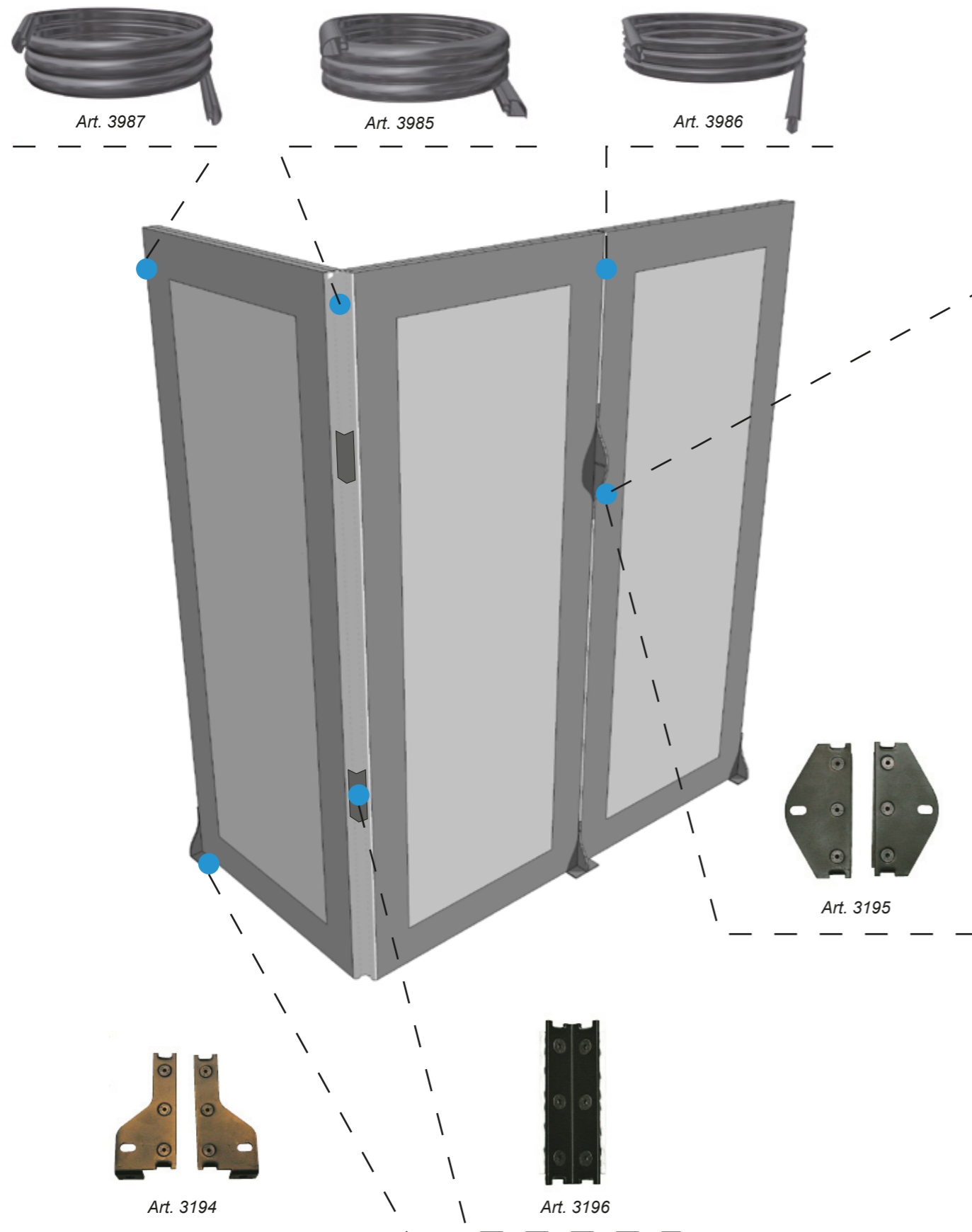

Bulloni di fissaggio - Fixing bolts
 Boulons de fixation - Pernos de fijado
 Фиксирующие болты

Contropiastra di rinforzo in acciaio zincato - Steel zinc plate for reinforce
 Plaque de renforcement en acier galvanisé - Placa de refuerzo en acero cincado
 Усиливающая плита из оцинкованной стали

Squadretta in acciaio zincato
 Angular steel zinc plate
 Angulaire en acier galvanisé
 Angular en acero cincado

Крепежная накладка из оцинкованной стали

Profilo 3186 porta pannello
 3186 profile for panel support
 Profile 3186 support panneau
 Perfil 3186 soporte panel
 Профиль 3186 для панелей

Bulloni di fissaggio - Fixing bolts
 Boulons de fixation - Pernos de fijado
 Фиксирующие болты

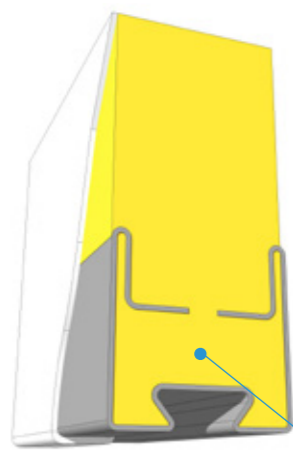

Sistema di fissaggio a schiumare
 Fixing system to be foam
 Système de fixation avec mousse
 Sistema de fijación con espuma
 Система фиксации на пену

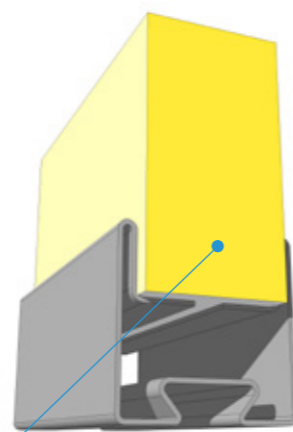

Sistema di fissaggio ad infilare
 Fixing system to be insert
 Système de fixation à enfilet
 Sistema de fijado a insertar
 Стыковочная система фиксации

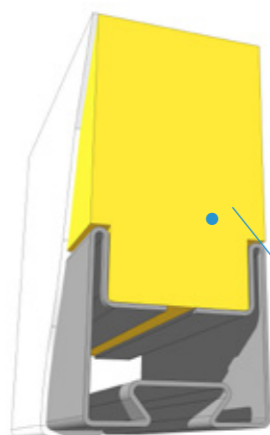

Sistema di fissaggio ad incollare
 Fixing system to be glue
 Système de fixation avec colle
 Sistema de fijación con cola
 Система фиксации на клей

