

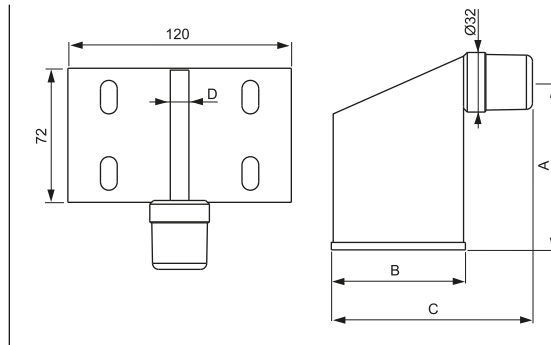







Materiale: Acciaio Zincato



-  *Final galvanized steel stop for sliding gates*
-  *Butée en acier zingué pour grilles coulissantes*
-  *Tope para puerta corredera en acero cincado*
-  *Ограничитель хода раздвижных ворот*
-  *Torendpuffer für Schiebtore aus verzinktem Stahl, zum Anschrauben*

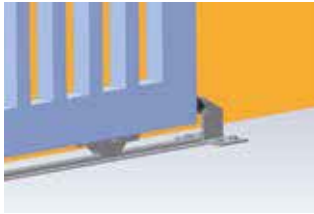

Art.	A	B	C	D	Asole	Peso(g)	Conf.
-	-	-	-	-	Holes	Weight(g)	Pack
<b>151/1.2</b>	73	50	98	8	18 x 9mm	580	10
<b>151/2.2</b>	90	70	108	10	18 x 9mm	820	10