

Checkout the NOVA-FERR YouTube channel to watch AGILE2.0 in action and much more!



Our brands:



Authorised dealer:

# Agile2.0

Pintle and gate closer in one single product



10070 Grosso (TO) - Località Vauda 12  
Tel. 0039 011 92 68 262 - Fax 0039 011 92 60 009  
Mail: info@novaferr.com - www.novaferr.com



# THE ADVANTAGES OF Agile2.0

PINTLE AND GATE CLOSER  
IN ONE SINGLE PRODUCT  
=  
GREATER SAVINGS



## MECHANICAL SYSTEM

The mechanical movement of Agile2.0 allows the product to **need less regulations compared to standard hydraulics systems**, which are greatly influenced by temperature fluctuations.

The regulation is really simple: **you just need an Allen key!**

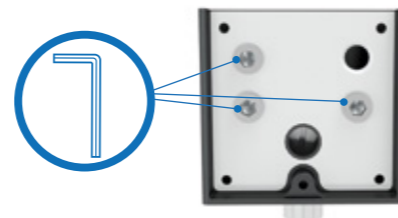

## REVERSIBLE

Agile2.0 can **change from right-handed to left-handed** (and vice versa) by simply switching the position of the springs.

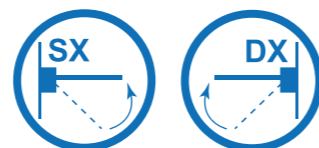

## TO BE WELDED OR TO BE SCREWED



With the provided bushing, Agile2.0 can be **installed by welding or screwing** it on the gate leaf.

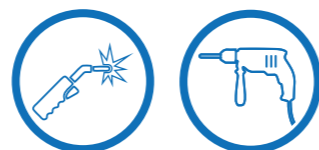

## CAN BE ADAPTED WITH PRE-EXISTING PINTLES

Agile2.0 can be installed, **solely with the gate closer function**, even with a pre-existing pintle:

When the gate closer can be mounted on the same axis with the existing pintle, the adjustable **L-bracket** is used.

When the Agile2.0 cannot be mounted on the same axis with the existing pintle, **the compass arm or the arm with guide** is used.

### With adjustable L bracket

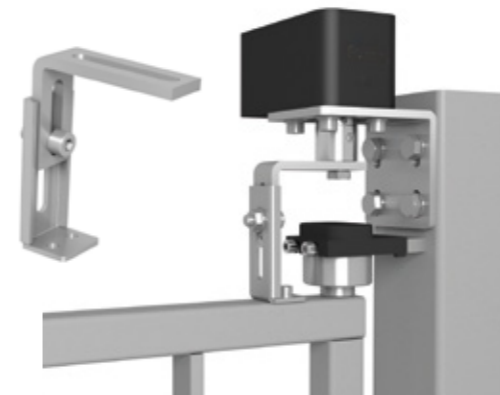

### Compass arm kit



### Arm with guide kit

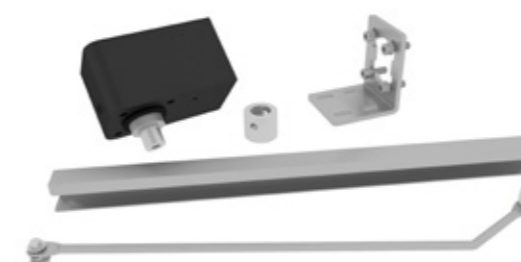
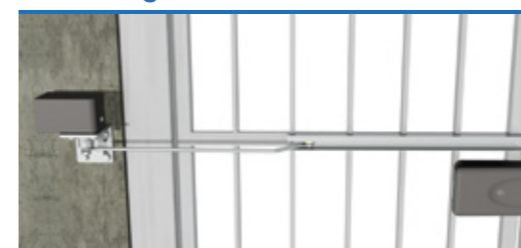

## GATE OPENER FUNCTION

Agile2.0 can be **easily transformed from gate closer to gate opener** by varying the position of the springs. This function works well with electric locks with remote control.



## RESISTANT

Thanks to the **cataphoresis treatment**, Agile2.0 is exceptionally resistant to weather agents.



## ECO-FRIENDLY

**No oil to dispose of** thanks to its mechanical system.

All its components are recyclable.



## ADDITIONAL INFORMATION

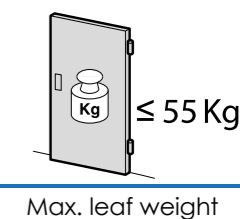
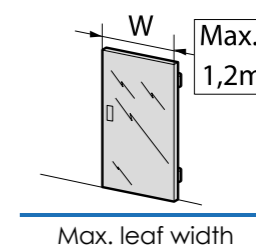

### Available in two colours:

MICACEOUS BLACK  
BRIGHT ALUMINIUM



Agile2.0 has two main functions:

- Pintle
- Gate closer

