

**NOVA-FERR srl**

L'innovazione la chiave del successo



CATALOGO  
PRODOTTI  
N°25

La garanzia del prodotto  
**MADE IN ITALY**

  
[www.novaferr.com](http://www.novaferr.com)

**Presentazione**

Introduction | Présentation | Presentación | Präsentation

**Pag.2****Accessori per cancelli**

Gates accessories | Accessoires pour portails | Accesorios para puertas | Zubehör für Pforten

**- Acc. cancelli scorrevoli** | Sliding gate accessories | Accessoires portails coulissants | Accesorios puertas correderas  
Zubehör für Schiebetore**Pag.10****- Acc. cancelli a battente** | Swing gates accessories | Accessoires portails battants | Accesorios puertas batientes  
Zubehör für Drehflügeltore**Pag.32****- Acc. cancelli autoportanti** | Self-supporting gates accessories | Accessoires portails autoportants  
Accesorios puertas autoportantes | Zubehör für freitragende Tore**Pag.52****- Ornamenti** | Ornaments | Ornaments | Adornos | Ornamente**Pag.70****- Acc. vari per cancelli ed altri usi** | Various accessories for gates and other uses | Divers accessoires pour portails et autres usages | Varios accesorios para puertas y otros usos | Verschiedenes Zubehör für Tore und andere Anwendungen**Pag.78****Accessori per sistemi scorrevoli**Sliding system accessories | Accessoires pour systèmes coulissants | Accesorios para sistemas correderos  
Zubehör für Schiebesysteme**Pag.92****Accessori per porte blindate**Blast doors accessories | Accessoires pour portes blindées | Accesorios para puertas blindadas |  
Zubehör für gepanzerte Türen**Pag.106****Cerniere per usi vari**Hinges for various uses | Charnières pour divers usages | Bisagras para diversos usos  
Scharniere für verschiedene Anwendungen**Pag.122****Accessori per grate di sicurezza**Safety gates accessories | Accessoires pour grilles de sécurité | Accesorios para rejilla de seguridad  
Zubehör für Sicherheitsgitter**Pag.132****Serrature**

Locks | Serrures | Cerraduras | Schlösser

**Pag.146****Accessori per portoni industriali**Accessories for industrial doors | Accessoires pour portes industrielle | Accesorios para puertas industriales  
Zubehör für Industrietore**Pag.168****Accessori per finestre**

Windows accessories | Accessoires pour fenêtres | Accesorios para ventanas | Zubehör für Fenster

Controtelai ARTIK | ARTIK counterframes | Contrecadres ARTIK | ARTIK Gegenzargen

**Pag.218**

Genioblock

**Pag.220****Accessori per facciate continue**

Curtain wall accessories | Accessoires pour murs-rideaux | Accesorios para muros cortina | Zubehör für Vorhangfassaden

**Pag.222****Accessori veicoli industriali**

Acc. for trucks | Acc. pour camion | Acc. para vehículos industriales | Fahrzeugverschlüsse und Zubehör

**Pag.228****Linea legno**

Wood line | Ligne pour bois | Línea por madera | Holz Linie

**Pag.234****Indice Analitico**

Analytical index | Index analytique | Índice analítico | Suchindex

**Pag.272****Legenda**

Legend | Légende | Leyenda | Условные обозначения | Legende

**Pag.277**

## Condizioni generali di vendita



**PREZZI** - I prezzi presenti nel listino, salvo diversa indicazione, sono espressi in € e si riferiscono, se non specificato, al singolo pezzo o al metro lineare.

**PAGAMENTO** - Il committente è tenuto a pagare secondo le date pattuite. Nel caso di ritardi, per qualsiasi ragione, saranno addebitati gli interessi di mora pari ad un tasso uguale al tasso di sconto ufficiale in vigore durante il periodo d'insolvenza. La società si riserva in qualsiasi momento il diritto di sospendere le forniture qualora ravvisasse nel committente insolvenze o esposizione troppo elevata. Eventuali contestazioni per difetti della merce fornita o per ritardi di fornitura, non possono costituire in nessun caso motivo di sospensione dei pagamenti.

**CONSEGNA** - I termini di consegna sono da ritenersi indicativi e sono espressi in giorni lavorativi. La consegna è effettuata al massimo entro 30gg dalla ricezione dell'ordine. Eventuali ritardi non potranno giustificare l'annullamento dell'ordine né richieste di risarcimento per eventuali danni diretti o indiretti.

**TRASPORTO** - La merce viaggia sempre a rischio e pericolo del committente anche quando è stato concordato il franco destino. Se all'arrivo la merce o l'imballaggio ha subito danni, il Cliente è tenuto a contestarli allo Spedizioniere. Se il danno è dovuto a nostra negligenza, le contestazioni saranno accettate solo se riportate sul documento di trasporto ed in tutte le copie.

**RESI** - Non si accettano resi se non preventivamente autorizzati dalla nostra Società. Al ricevimento del reso sarà emessa nota di accredito, previo controllo della merce e del suo imballo, dedotta di eventuali costi per il ripristino della merce, di trasporto o di rifacimento imballi.

**CARATTERISTICHE TECNICHE** - Tutte le caratteristiche tecniche riferite ai nostri prodotti presenti nel catalogo, sono da considerarsi indicative. Ci riserviamo in qualsiasi momento di approvare variazioni sia tecniche che estetiche, senza nessun preavviso.

**CONTROVERSIE** - Per qualsiasi controversia il foro competente è quello di Torino.



**PRICES** - The prices in the pricelist are in €, unless otherwise indicated. Prices apply to each single piece or per linear meter, if not specified otherwise.

**PAYMENT** - Customer payment is required according to the agreed-upon dates. In case of any delay for any reason, default interest will be charged equal to the official discount rate in effect during the contested period. Our company reserves the right at any time to suspend the supply of materials in cases where the buyer shows excessive signs of exposure and insolvency. Possible complaints due to defects or delays of the supplied merchandise constitute no reason for suspension of payment.

**DELIVERY** - Terms of delivery are only indicative and are expressed in work-days. Utmost effort is made to deliver within 30 days of receipt of the order. Possible delays will not justify cancelling nor modification of the terms and conditions of the order, as a result of direct or indirect damages.

**TRANSPORTATION** - The merchandise travels at buyer's own risk even when D.D.P. delivery has been agreed upon. If upon arrival the merchandise or packaging is damaged, the customer must notify the shipping agent. If damage is due to our negligence, notification of the charges will be accepted only if they are reported on the original and all copies of the shipping document.

**RETURNED MERCHANDISE** - Merchandise can be returned only if it has been previously agreed upon with our company. Upon receipt of returned merchandise and after inspection of the goods and packaging, a credit note will be issued. A deduction for possible costs for any necessary maintenance/repair/overhaul, repackaging, and shipping will be applied.

**TECHNICAL CHARACTERISTICS** - All the technical characteristics referred to the products in our catalogue are indicative. We reserve the right at any moment to make any variations, technical or in appearance, without prior notice.

**DISPUTES** - For any claims, the laws of the court of Turin, Italy will apply.



**PRIX** - Les prix indiqués en la liste de prix sont en€, sauf indication différente et ils se réfèrent à une pièce ou mètre linéaire.

**PAIEMENT** - Le client s'engage à payer aux échéances concordées. En cas de retard, pour n'importe quelle raison, il y aura à payer les intérêts moratoires dans la même mesure du taux d'escompte officiel en vigueur pendant la période d'insolvabilité. La société se réserve en tout moment le droit de suspendre les fournitures en cas d'insolvabilité du client ou en cas d'exposition financière trop élevée. D'éventuelles réclamations pour défauts de marchandise fournie ou pour des retards de livraison ne peuvent en aucun cas être motif de suspension de paiements.

**LIVRAISON** - Les termes de livraison sont indicatifs et sont indiqués en jours ouvrables. La livraison est effectuée dans un maximum de 30 jours de la réception de la commande. D'éventuels retards ne justifieront pas l'annulation de la commande ni demandes de remboursement pour d'éventuels dommages directs ou indirects.

**TRANSPORT** - La marchandise voyage aux risques et périls du destinataire même en cas de vente DDP. Si la marchandise ou l'emballage présentent des dommages, le client à réception est tenu à le signaler au courrier. Si le dommage est dû à notre négligence, les contestations seront acceptées uniquement si mentionnées sur le document de transport et sur toutes les copies.

**RETOUR DE MARCHANDISE** - La société n'accepte aucun retour sans accord préalable. A réception de la marchandise retournée la société émettra une note de crédit après contrôle des marchandises et emballages, avec déduction éventuelle des coûts pour le recouvrement des marchandises, transport ou réemballage.

**CARACTERISTIQUES TECHNIQUES** - Toutes les caractéristiques techniques relatives à nos produits en catalogue doivent être considérées indicatives. La société se réserve le droit d'apporter, en tout moment, des modifications techniques et esthétiques sans aucun préavis.

**LITIGES** - En cas de litiges, le tribunal de Turin IT, est le seul compétent.

## Condizioni generali di vendita



**PRECIOS** - Los precios en la lista de precios son en € y se refieren por pieza o por metro lineal, a menos que no haya sido previamente especificado de otra manera.

**PAGO** - El cliente se compromete a pagar en las fechas establecidas. En el caso de demora, por cualquier motivo, le serán adeudados cargos de mora con intereses iguales a la tasa del descuento oficial en vigor durante el período de insolvencia. La sociedad se reserva en cualquier momento el derecho de suspender el envío de la orden si esta descubriera la existencia de insolvencias o exposición demasiado elevadas por parte del cliente. Eventuales reclamos debidos a defectos de la mercancía o retrasos en el envío de la misma, no constituyen en ningún caso motivo para suspender los pagos.

**ENTREGA** - Los términos de entrega son solamente indicativos y son expresados en días laborales. La entrega se efectúa como máximo dentro de 30 días de recibida la orden. Eventuales demoras no pueden justificar la anulación de la orden ni la demanda de indemnización por eventuales danos directos o indirectos.

**TRANSPORTE** - La mercancía viaja siempre por riesgo y cuenta del cliente aún cuando se haya acordado el flete a destino (D.D.P.). Si a la llegada, la mercancía o el embalaje han sufrido daños, el cliente deberá presentar su reclamo al expedidor. Si el daño es debido a nuestra negligencia, los reclamos serán aceptados solamente si éstos están especificados en el original y en todas las copias del documento de transporte.

**DEVOLUCIONES** - No se aceptan devoluciones sin la previa autorización de nuestra Sociedad. Al recibo del material devuelto se emitirá una nota de abono sólo después que la mercancía y el embalaje sean controlados. En caso necesario si hubieran ulteriores costos de manutención, transporte o de nuevo embalaje, éstos serán restados de la nota de abono.

**CARACTERISTICAS TECNICAS** - Todas las características técnicas que se refieren a nuestros productos presentes en este catálogo son de forma indicativa. Nos reservamos el derecho en cualquier momento de hacer variaciones sean éstas técnicas o estéticas, sin previo aviso.

**CONTROVERSAS** - Para cualquier controversia, se aplicarán las leyes de la corte de Turín, Italia.



**ЦЕНЫ** - цены в прейскуранте, если не указано иное, выражены в € и относятся, если не указано, к отдельному куску или линейному метру.

**Оплата** - Покупатель обязан оплатить товар в соответствии с указанными сроками. В случае не оплаты, Покупатель должен будет оплатить пению Продавцу. Если Покупатель вовремя не оплатил заказанный продукт, производитель имеет право отклонить все намеченные поставки с Покупателем. Покупатель обязан оплатить товар, даже если были задержки по срокам и изготовлению заказанного продукта.

**Сроки поставки** - отгрузка товара осуществляется только в рабочие дни. Максимальный срок поставки 30 рабочих дней с момента подтверждения заказа. При задержке срока поставки товара – производитель ответственности не несёт.

**Транспорт** - При транспортировке товара – ответственность несет Покупатель или перевозчик. Если товар или упаковка были повреждены, Покупатель вместе с перевозчиком должны составить акт.

**Брак** - Бракованный товар без соответствующего подтверждения производителя не принимается. Если брак признается по вине производителя – деньги возвращаются Покупателю.

**Технические характеристики** - все характеристики указанные в каталоге могут быть ориентировочные и (или) изменяться без уведомления Покупателя.

**Споры и разногласия** - Неурегулированные в претензионном порядке споры, подлежат к рассмотрению в суде по месту дислокации ответчика Турин - Италия.



**PREISE** - Die Preise in der Preisliste sind, sofern nicht anders angegeben, in € angegeben und beziehen sich, sofern nicht anders angegeben, auf das einzelne Stück oder den linearen Meter.

**BEZAHLUNG** - Der Kunde muss innerhalb der bestimmten Frist zahlen. Im Falle einer Verspätungen, aus irgendeinem Grund, werden die Verzugszinsen nach dem gleichen Satz des offiziellen Diskontsatz geltenden, während die Zeit der Insolvenz, gerechnet. Das Unternehmen behält sich das Recht vor, jederzeit ohne Vorankündigung, die Lieferungen auszusetzen, wenn Insolvenz oder zu hohe Exposition des Käufers erkennt. Mögliche Anträge für defekte der gelieferten Waren oder Verspätungen, können nicht in jedem Fall als Grund für die Aussetzung von Zahlungen sein.

**LIEFERUNG** - Die Lieferbedingungen sind beispielhaft und werden in Arbeitstagen ausgedrückt. Die Lieferung wird innerhalb von 30 Tagen durchgeführt.

**TRANSPORT** - Die Ware reisen immer auf Risk und Gefahr des Kunden, auch wenn das Schicksal vereinbart ist. Wenn die Ware eingetroffen ist oder die Verpackung beschädigt wurde, ist der Kunde verpflichtet, mit dem Absender zu konkurrieren. Wenn der Schaden auf unsere Fahrlässigkeit zurückzuführen ist, werden die Streitigkeiten nur akzeptiert, wenn sie auf dem Transportdokument und in allen Kopien gemeldet werden.

**RÜCKGABE** - Rücksendungen werden nicht angenommen, wenn sie zuvor von unserer Firma genehmigen worden. Am Empfang der zurückgegebenen Waren, nach Prüfung des Inhalts und der Verpackung, werden wir eine Gutschrift, abzüglich der Kosten für den Wiedererstellungskosten der Waren, den Transport oder Verpackung, auszugeben.

**TECHNISCHE DATEN** - Alle technischen Eigenschaften unserer Katalogprodukte, sind nur beispielhaft. Wir behalten uns jederzeit das Recht vor, technischen als auch ästhetischen Änderungen zu genehmigen, ohne vorherige Ankündigung.

**STREITFÄLLE** - Für jeden Rechtsstreit ist das Gericht von Turin zuständig.



**IT** La Nova-Ferr S.r.l. di Grosso Canavese (To) fondata nel 1980 è un'azienda specializzata a livello nazionale e internazionale nella progettazione e produzione di accessori per ferramenta, accessori per serramenti in genere e chiusure industriali. Fornisce una vasta gamma di articoli per il settore delle costruzioni in carpenteria metallica, siderurgico e meccanico. L'attenzione per la qualità del prodotto e del servizio rivolto alla clientela è stata perseguita con l'adozione di un sistema di qualità conforme alla UNI EN ISO 9001:2015.

**UK** Nova-Ferr S.r.l. in Grosso Canavese (Torino) founded in 1980, is a Company nationally and internationally specialized in the design and production of accessories for ironmongery, doors, windows, shutters and industrial doors. Nova-Ferr Srl. supply a wide range of items suitable for mechanical, steel, iron and metal structural construction field. Attention to quality and service of product supplied to clients has been followed adopting a quality system according to UNI EN ISO 9001:2015.

**FR** Nova Ferr Srl, situé à Grosso Cavanese (Torino) fondée en 1980, est une société spécialisée, à un niveau national et international, dans l'étude et la production d'accessoires de quincaillerie de fermetures, et d'accessoires de portails industriels. Une vaste gamme d'articles est disponible, pour le secteur de la construction métallique, de la menuiserie bois, et de la menuiserie métallique. L'attention pour la qualité des produits et du service à la clientèle, a été suivie, en adoptant un système de contrôle de qualité conforme à la norme UNI EN ISO 9001:2015.

**ES** Nova-Ferr Srl situada en Grosso Canavese (Torino), fundada en 1980 es una empresa especializada a nivel nacional e internacional en diseñar y producir accesorios para las ferreterías y las herrajes e industriales. Propone una vasta gama de artículos para el sector de la construcción metálica, siderúrgica y mecánica. La atención por la calidad del producto y por el servicio ofrecido al cliente son garantías del proceso de un sistema activo de calidad conforme a la UNI EN ISO 9001:2015.

**DE** Das Unternehmen Nova-Ferr S.r.l. aus Grosso Canavese (Torino) wurde 1980 gegründet und ist sowohl national wie auch international auf die Entwicklung und Produktion von Eisenwaren, Zubehör für Schließvorrichtungen und industriellen Verschlüssen spezialisiert. Es bietet eine breite Palette von Produkten in den Bereichen von Stahlkonstruktionen für Metallarbeiten, Stahl- und Maschinenbauindustrie, Tür- und Torindustrie. Produktqualität und Kundenservice werden durch einen aktiven Prozess nach UNI EN ISO 9001:2015 festgeschrieben.

### Contatti | Contact | Contacts | Contactos | Kontakte

#### NOVA-FERR.SRL.

Sede operativa e Sede legale  
Operational and Legal Headquarters

Località Vauda, 12  
10070 Grosso (Torino), Italy  
Tel. +39 011 92 68 262  
Fax +39 011 92 60 009  
Mail [info@novaferr.com](mailto:info@novaferr.com)  
Web [www.novaferr.com](http://www.novaferr.com)

#### Ufficio Commerciale

Sales department / Bureau des ventes  
/ Departamento de venta / Handelsbüro

#### Vendite Italia

Sales Italy / Vente Italie / Ventas italia  
Italienische Verkäufe

[commitalia@novaferr.com](mailto:commitalia@novaferr.com)

#### Vendite Estero

International sales / Ventes étranger / Ventas extranjero  
Verkäufe im Ausland

[export@novaferr.com](mailto:export@novaferr.com)

#### Ufficio Amministrazione

Bookkeeping department / Bureau administration  
/ Departamento Administrativo / Verwaltungsbüro  
[contabilita@novaferr.com](mailto:contabilita@novaferr.com)

#### Ufficio Acquisti

Purchase department / Bureau achats  
/ Departamento de compras / Einkaufsbüro  
[acquisti@novaferr.com](mailto:acquisti@novaferr.com)

#### Ufficio Tecnico

Technical department / Bureau technique  
/ Departamento Técnico / Technischesbüro  
[ufftecnico@novaferr.com](mailto:ufftecnico@novaferr.com)

#### Lingue parlate in azienda





Attrezzaggio / Tools / Outils / Utillaje / Ausrüstung



Profilatura / Profiling / Profilage / Perfilado / Profilschleifen



Stampaggio a freddo / Cold forming / Estampage à froid / Estampado en frío / Kaltpressen



Stampaggio lamiera / Steel sheet forming / Estampage tole / Estampación de chapa / Eisenblech



Tornitura / Turning / Tournage / Torneado/ Dreharbeit



Controlli / Check area / Controles / Tornos de control numérico / Kontrollen



Assemblaggio / Assembling / Assemblage / Ejecución de ensamblaje / Zusammenbau



Magazzino / Warehouse / Magasin / Almacén / Warenlager

Nova-Ferr da sempre produce accessori per chiusure tecniche industriali proponendo sistemi e soluzioni innovativi e certificati. Per visionare tutta la gamma di prodotti e servizi offerti vi invitiamo a visionare il nostro sito [www.novaferr.com](http://www.novaferr.com)

**ACCESSORI PER PORTONI****CANTILEVER****STAFFE PER FACCIATE****ARTIK KIT****RUOTE****CARDINI**



**Unica**

CERNIERE A SCOMPARSA | CONCEALED HINGES  
 CHARNIÈRES CACHÉES | BISAGRAS OCULTAS  
 VERDECKTE SCHARNIERE



**Link**

CARDINI A FASCIA | BAND HINGES  
 CHARNIÈRES À BANDE | BISAGRAS DE BANDA  
 BANDSCHARNIERE



**Genioblock**

CHIUSURE DI SICUREZZA | SAFETY LOCKS  
 SERRURES DE SÉCURITÉ | CIERRES DE SEGURIDAD  
 SICHERHEITSSCHLÖSSER



**Kassel**

SERRATURE | LOCKS  
 SERRURES | CERRADURAS  
 SCHLÖSSER



**CANTILÉVER**  
 Gate System

**Uisse**

CANCELLI SCORREVOLI E AUTOPORTANTI  
 SLIDING AND SELF-SUPPORTING GATES  
 PORTAILS COULISSANTS ET AUTOPORTANTS  
 PUERTAS CORREDERAS Y AUTOPORTANTES  
 SCHIEBE- UND FREITRAGENDE TORE



**NF Rapido**

ACCESSORI PER GRATE DI SICUREZZA  
 ACCESSORIES FOR SECURITY GRILLES  
 ACCESSOIRES POUR GRILLES DE SÉCURITÉ  
 ACCESORIOS PARA RED DE SEGURIDAD  
 ZUBEHÖR FÜR SICHERHEITSGITTER



## I materiali

---

I materiali utilizzati per la realizzazione dei prodotti Nova-Ferr srl sono:

- Acciaio:** per i reparti di stampaggio lamiera
- Trafilati:** per il reparto torneria
- Laminati:** per il reparto a controllo robotizzato ruote
- Filo acciaio:** per il reparto stampaggio a freddo

I materiali sono esclusivamente materiali certificati, reperiti dalle più importanti acciaierie Europee. Inoltre tutti i materiali metallici, finiti, semilavorati e grezzi, subiscono nei vari percorsi produttivi: verifiche strutturali e verifiche tramite rilievo delle caratteristiche meccaniche e tecnologiche, garantendo una sempre e più valida strategia di orientamento nelle scelte dei materiali e nella ricerca delle performance.

Per garantire la giusta resistenza alle severe condizioni climatiche cui sono sottoposti i nostri prodotti ed ai sempre crescenti requisiti estetici, tutti gli articoli prodotti dalla NOVA-FERR srl vengono sottoposti a trattamenti superficiali come la **verniciatura e la zincatura**.

## Le certificazioni

---

L'attenzione per la qualità del prodotto e del servizio rivolto alla clientela è stata perseguita con l'adozione di un sistema di qualità conforme alla UNI EN ISO 9001:2015.

Sistema di gestione per la qualità  
*Quality system management*

---



*Types de portails | Tipos de puertas | Arten von Gates*

### CANCELLI SCORREVOLI SU RUOTE

*Sliding gates on wheels | Portails coulissants sur roues | Puertas correderas con ruedas  
Откатные ворота на колесах | Schiebetore auf Rädern*

**Pag. 10**

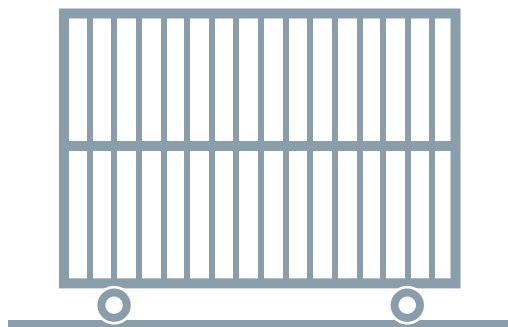

### CANCELLI A BATTENTE

*Swing gates | Portails battants | Puertas batientes  
Распашные ворота | Schwingtore*

**Pag. 32**



### CANCELLI AUTOPORTANTI

*Self-supporting gates | Portails autoportants | Puertas autoportantes  
Самонесущие ворота | Selbsttragende Tore*

**Pag. 52**



# NOVA-FERR srl

ACCESSORI PER CANCELLI SCORREVOLI  
ACCESSORIES FOR SLIDING GATES



Rulli e Supporti



Cremagliere e Perni

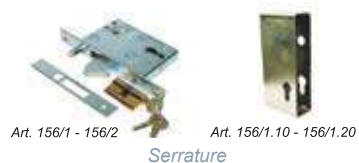

Serrature



Arresti di fine corsa

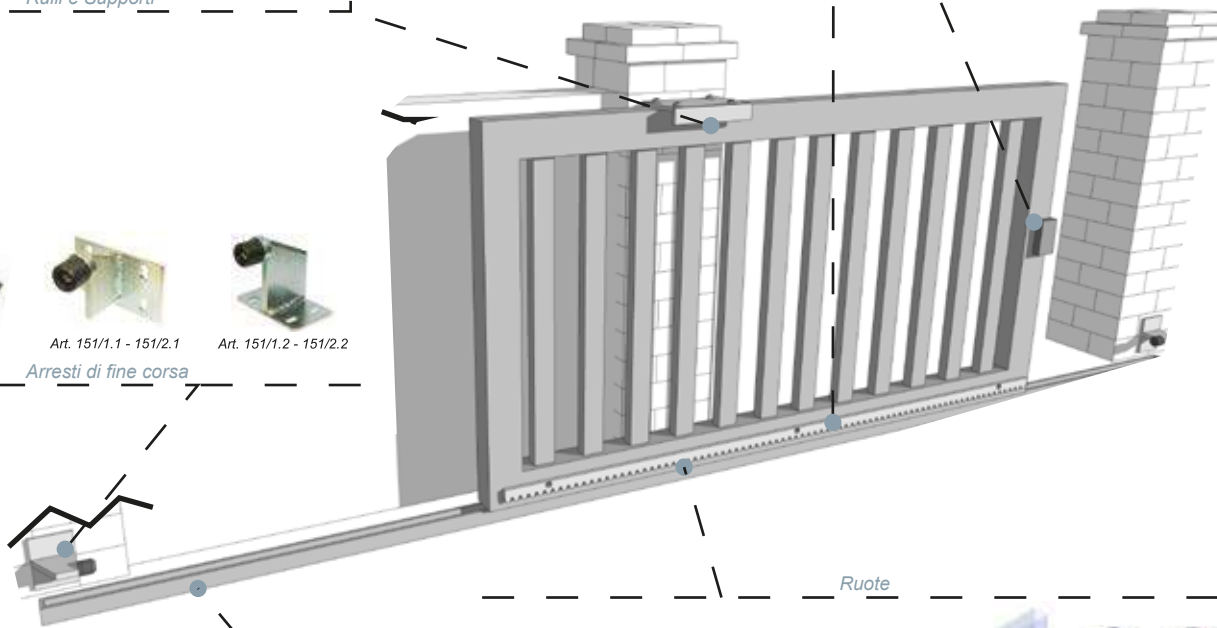

Guide ad avvitare



Guide a cementare

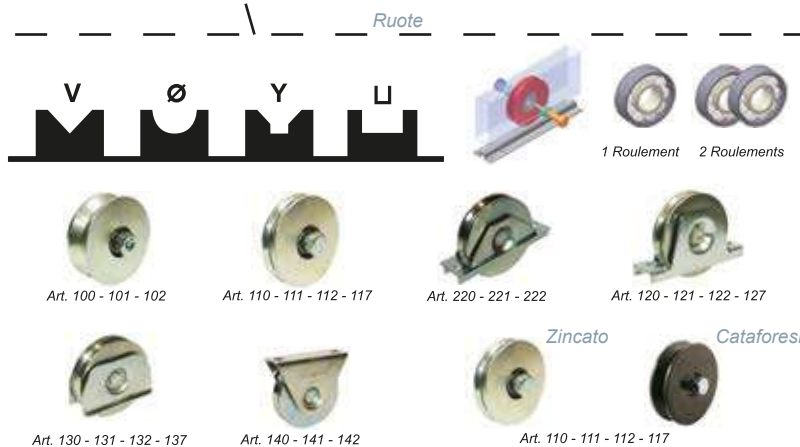

Ruote

1 Roulement 2 Roulements

Zincato

Cataforesi

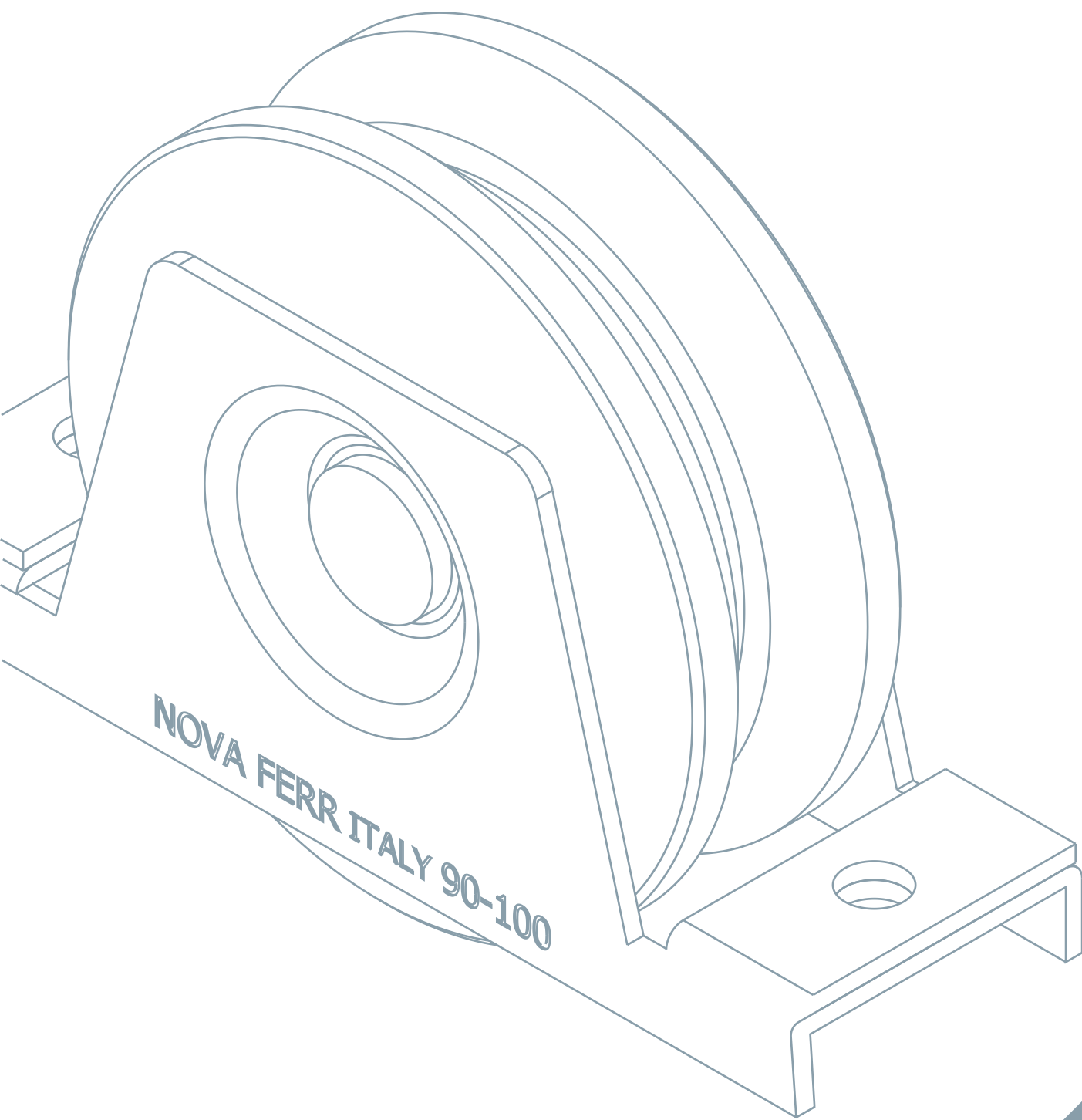

# ACCESSORI PER CANCELLI SCORREVOLI

Sliding gate accessories - Accessoires portails coulissants  
Accesorios puertas correderas  
Zubehör für Schiebetore

**CATALOGO  
N.25**

## Tipologia ruote

### ZINCATURA

Tutte le nostre ruote subiscono una protezione superficiale da 7µ a 11µ classe II a garanzia dei requisiti richiesti.

All our wheels are protected from 7µ to 11µ class II to guarantee the demanded requirements.



### CATAFORESI

La Cataforesi è caratterizzata dal deposito uniforme di una resina epossidica che assicura a lungo una straordinaria protezione nei confronti di tutti gli agenti atmosferici e di qualunque altro tipo di attacco.

The cataphoresis is characterized by the even deposit of an epoxy resin that guarantees a long and extraordinary protection towards every atmospheric agent and to any other type of attack.



### Ruote a 1 cuscinetto

Tipo di gola  
Diametro ruota da Ø 50 a Ø 160  
Spessore ruota 17 - 20 - 25mm

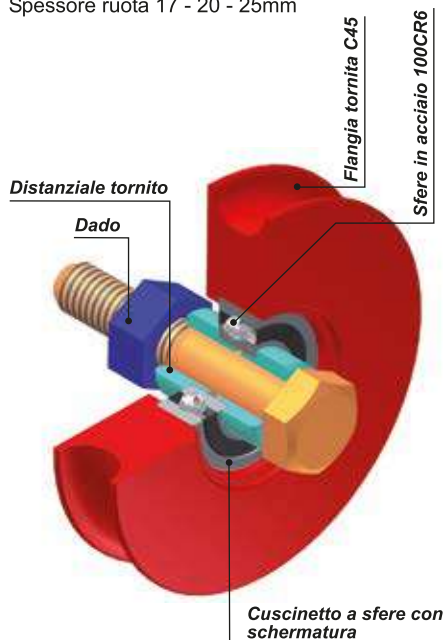

### Ruote a 2 cuscinetti

Tipo di gola  
Diametro ruota da Ø 100 a Ø 250  
Spessore ruota 32mm

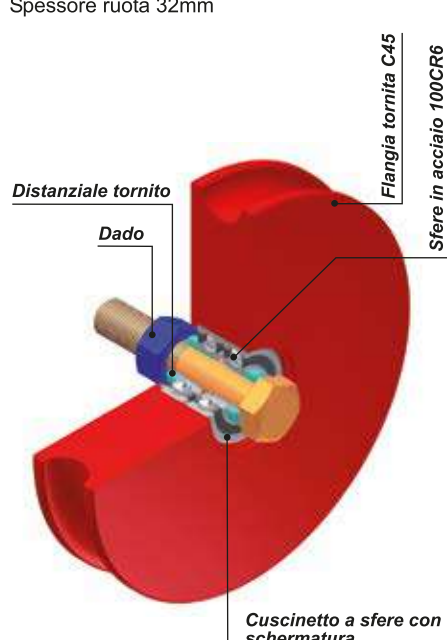

### Ruote a 2 cuscinetti C/ingrassatore

Tipo di gola  
Diametro ruota da Ø 120 a Ø 250  
Spessore ruota 25 - 38mm

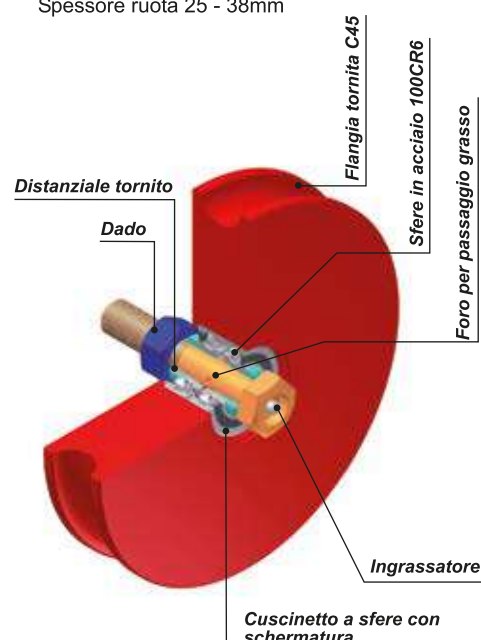

Metodi per il fissaggio delle ruote ai cancelli

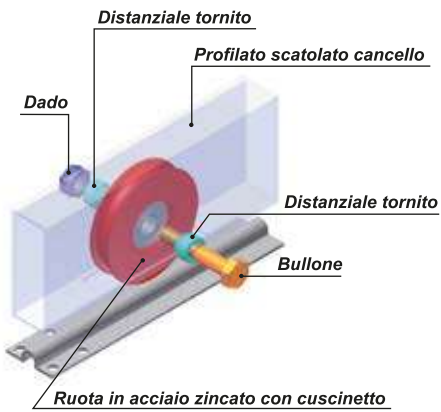

Ruote con bullone

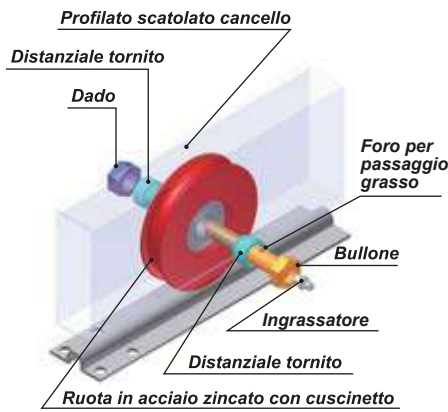

Ruote con bullone e ingrassatore

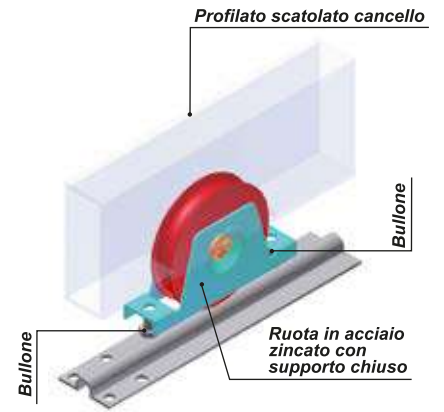

Ruote con supporto chiuso

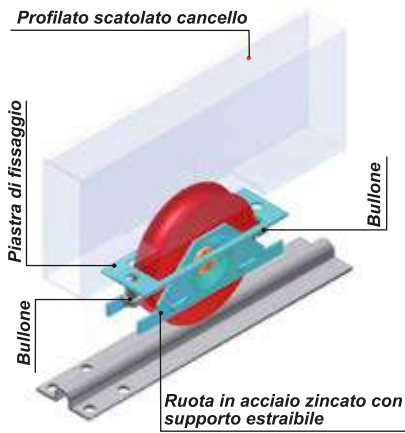

Ruote con piastra estraibile

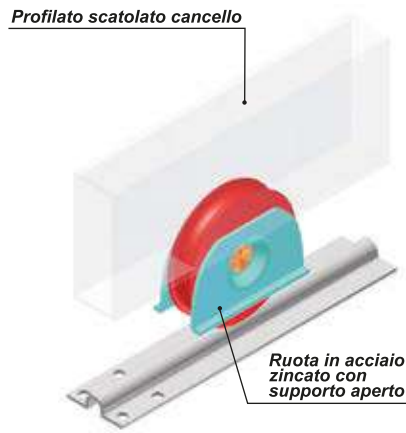

Ruote con supporto aperto

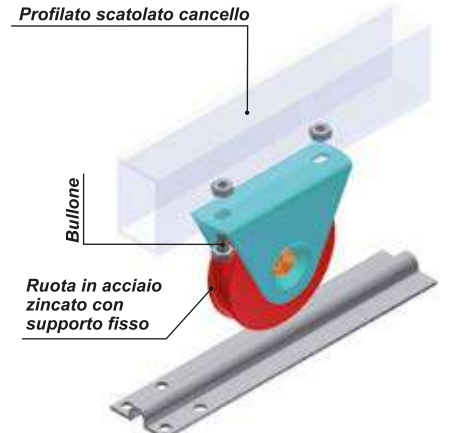

Ruote con supporto fisso

Abbinamenti profili guide / gole ruote  
Analisi sollecitazione - integrità strutturale

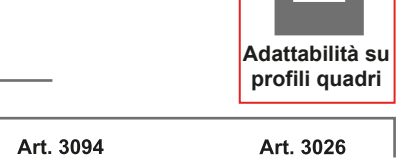
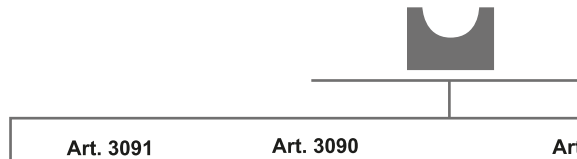
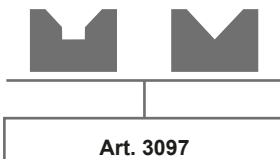

Adattabilità su  
profili quadri



Pressione applicata 100MPa  
Deformazione pari a: 0,01292mm

Pressione applicata 100MPa  
Deformazione pari a: 0,02158mm

Pressione applicata 100MPa  
Deformazione pari a: 0,02049mm

Pressione applicata 100MPa  
Deformazione pari a: 0,1864mm

Pressione applicata 100MPa  
Deformazione pari a: 0,06235mm

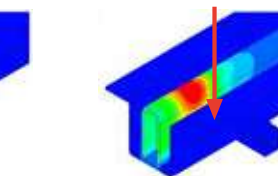
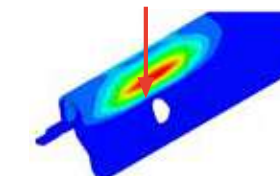
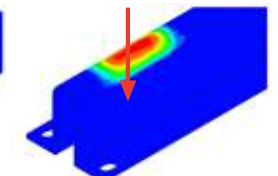
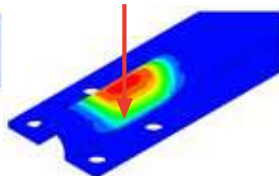
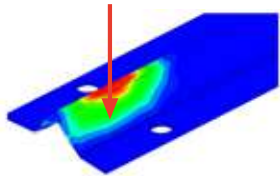

## Art. 3026

## Profilo zincato di 6mt a cementare filo pavimento

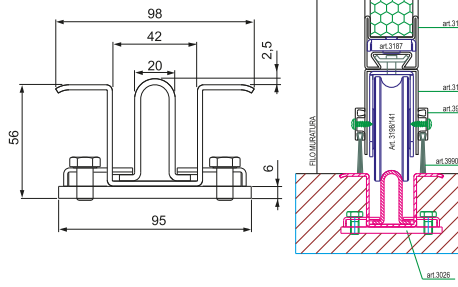

- Galvanized profile 6 mt. long to be cemented into floor
- Profil zingué 6 mt. à cimenter au sol
- Guía en acero cincado a cementar bajo el nivel del suelo
- Verzinktes Bodenführungsschiene zu zementieren, 6 Meter lang

Materiale: Acciaio Zincato

Art.	Peso(g/m)	Conf.
3026	6.550	20

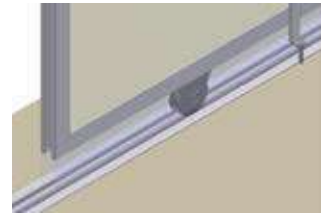

## Art. 3090

## Guida a cementare in acciaio zincato

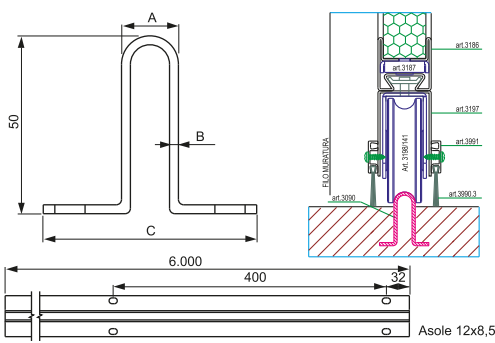

- Galvanized steel guide to be cemented
- Rail en acier zingué à cimenter
- Guía en acero cincado para cementar
- Bodenführungsschiene aus verzinktem Stahl zu zementieren

Materiale: Acciaio zincato

Art.	A	B	C	L(m)	Peso/m	Conf.	Imb.
3090/16.3	16	2,5	55	3	2.640	10	40
3090/16.6	16	2,5	55	6	2.640	10	40
3090/20.3	20	3	60	3	3.260	10	40
3090/20.6	20	3	60	6	3.260	10	40
3090/25.3	25	3	60	3	3.300	10	40
3090/25.6	25	3	60	6	3.300	10	40

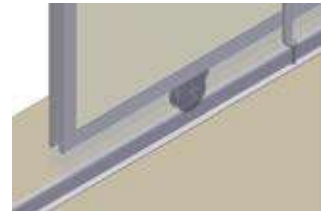

## Art. 3091

## Guida ad avvitare in acciaio zincato

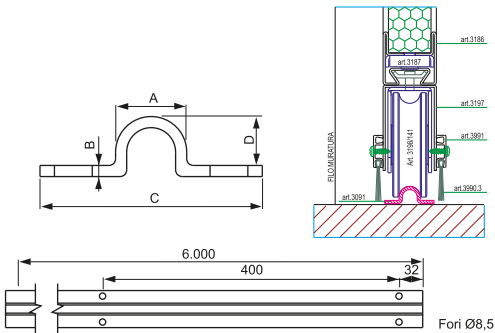

- Galvanized steel guide to be screwed
- Rail en acier zingué à visser
- Guía en acero cincado para atornillar
- Bodenführungsschiene aus verzinktem Stahl zu schrauben

Materiale: Acciaio Zincato

Art.	A	B	C	D	L(m)	Peso/m	Conf.	Imb.
3091/16.3	16	2,5	50	10	3	1.160	10	40
3091/16.6	16	2,5	50	10	6	1.160	10	40
3091/20.3	20	3	55	13,5	3	1.600	10	40
3091/20.6	20	3	55	13,5	6	1.600	10	40
13091/20.3	20	3	55	13,5	3	1.600	10	40

● INOX





**Guida ad avvitare in acciaio zincato**

**Art. 3097**

 Galvanized steel guide to be screwed

 Rail en acier zingué à visser

 Guía en acero cincado para atornillar

 Verzinkte Bodenlaufschiene zum Schrauben

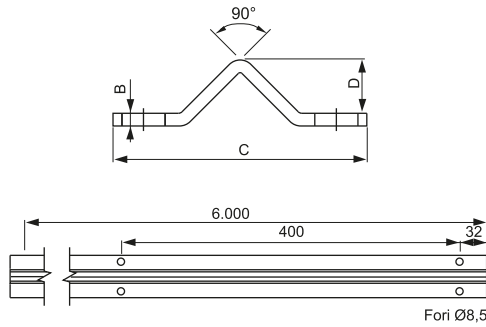

Materiale: Acciaio Zincato

Art.	B	C	D	L(m)	Peso/m	Conf.	Imb.
3097/V3	2,5	50	13	3	1.160	10	40
3097/V6	2,5	50	13	6	1.160	10	40

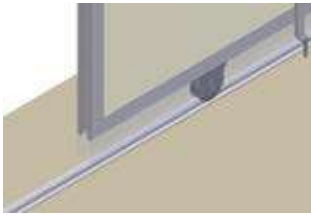



**Guida a cementare in acciaio zincato**

**Art. 3094 / 3096**

 Galvanized steel guide to be cemented

 Rail en acier zingué à cimenter

 Guía en acero cincado para cementar

 Verzinkte Bodenlaufschiene zum Zementieren

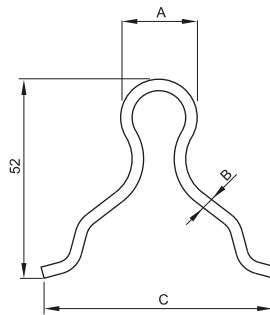

Materiale: Acciaio Zincato

Art.	A	B	C	L(m)	Peso/m	Conf.	Imb.
3094/20.3	20	3	60	3	3.065	10	40
3094/20.6	20	3	60	6	3.065	10	40
3096/20.3	20	4	60	3	4.105	10	40
3096/20.6	20	4	60	6	4.105	10	40

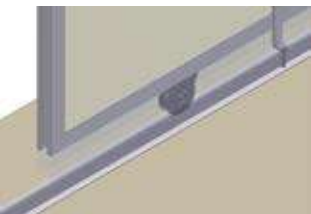

**Perno di giunzione per guida a cementare Art. 3094**

**Art. 3095**

 Junction pin for guide to be cemented Item 3094

 Pivot de jonction pour guide à cimenter Modèle 3094

 Eje de unión para guía a cementar Mod. 3094

 Verbindungsstift für Laufschiene zum Zementieren

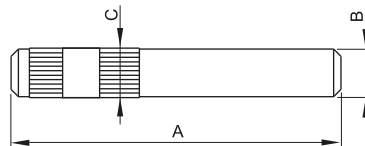

Materiale: Acciaio Zincato

Art.	A	B	C	Peso	Conf.
3095	64	13	13,5	188	25





## Art. 110 - 111 - 112 - 117 - 1 cuscinetto

## Ruota con bullone

Wheel with bolt Galet avec boulon Rueda con tornillo Schiebetore Rolle aus verzinktem Stahl oder Edelstahl mit Bolzen und einem Kugellager

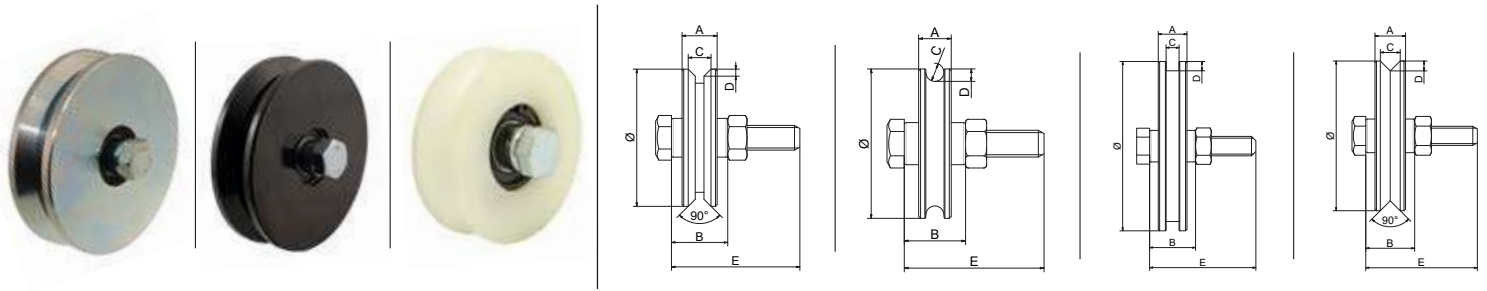

Materiale: Acciaio Zincato / Cataforesi / Nylon / Inox

1 Cuscinetto schermato 1 Ball bearing | 1 Roulement | 1 Rodamiento

**N.B. Per ordinare la versione Cataforesi aggiungere la lettera "C" alla fine del codice Es: 111/5/17/C**  
**Le versioni nylon sono indicate con la lettera "N" finale.**  
**To order the Cataphoresis model, add "C" at the end of the code. Ex.: 110/5/17/C**  
**The nylon versions are indicated with the final letter "N".**

INOX NYLON



Art.	Ø	A	B	C	D	E	Peso(g)	Conf.
110/5/17	50	17	19	11	4	10X45	220	25
110/6/17	60	17	19	10	3,5	10X45	300	20
110/7/20	70	20	32	13	4	14X70	500	12
110/8/20	80	20	32	13	4	14X70	680	10
110/9/20	90	20	32	13	4	14X70	850	10
110/10/20	100	20	32	13	4	14X70	1.100	8
110/12/20	120	20	32	13	4	14X70	1.600	6
110/14/20	140	20	32	13	4	14X70	2.200	6
110/16/20	160	20	32	13	4	14X70	2.900	6
110/8/25	80	25	32	20	7,5	14X70	700	8
110/10/25	100	25	32	20	7,5	14X70	1.190	6
110/12/25	120	25	32	20	7,5	14X70	1.800	6
110/14/25	140	25	32	20	7,5	14X70	2.520	6
110/16/25	160	25	32	20	7,5	14X70	3.330	6
1110/8/20	80	20	32	13	4	14X70	680	10
1110/10/20	100	20	32	13	4	14X70	1.100	8



Art.	Ø	A	B	C	D	E	Peso(g)	Conf.
117/5/17	50	17	19	11	5,5	10X45	220	25
117/6/17	60	17	19	11	5,5	10X45	300	20
117/7/20	70	20	32	13	6,5	14X70	500	12
117/8/20	80	20	32	13	6,5	14X70	680	10
117/9/20	90	20	32	13	6,5	14X70	850	10
117/10/20	100	20	32	13	6,5	14X70	1.100	8
117/12/20	120	20	32	13	6,5	14X70	1.600	6
117/14/20	140	20	32	13	6,5	14X70	2.200	6
117/16/20	160	20	32	13	6,5	14X70	2.900	6
117/8/25	80	25	32	20	10	14X70	700	8
117/10/25	100	25	32	20	10	14X70	1.190	6
117/12/25	120	25	32	20	10	14X70	1.800	6
117/14/25	140	25	32	20	10	14X70	2.520	6
117/16/25	160	25	32	20	10	14X70	3.330	6
1117/8/20	80	20	32	13	6,5	14X70	680	10
1117/10/20	100	20	32	13	6,5	14X70	1.100	8



Art.	Ø	A	B	C	D	E	Peso(g)	Conf.
111/5/17	50	17	19	9,5	6,5	10X45	210	25
111/6/17	60	17	19	9,5	6,5	10X45	280	20
111/7/17	70	17	19	9,5	6,5	10X45	390	14
111/8/17	80	17	19	9,5	6,5	10X45	520	14
111/7/20	70	20	32	16	8	14X70	490	12
111/8/20	80	20	32	16	8	14X70	590	10
111/9/20	90	20	32	16	8	14X70	840	10
111/10/20	100	20	32	16	8	14X70	970	8
111/12/20	120	20	32	16	8	14X70	1.560	6
111/14/20	140	20	32	16	8	14X70	2.170	6
111/16/20	160	20	32	16	8	14X70	2.850	6
111/8/25	80	25	32	20	10	14X70	630	8
111/10/25	100	25	32	20	10	14X70	1.080	6
111/12/25	120	25	32	20	10	14X70	1.650	6
111/14/25	140	25	32	20	10	14X70	2.390	6
111/16/25	160	25	32	20	10	14X70	3.200	6
1111/8/20	80	20	32	16	8	14X70	660	10
1111/10/20	100	20	32	16	8	14X70	1.050	8
111/8/25/N	80	25	32	20	10	14X70	630	6
111/9/25/N	90	25	32	20	10	14X70	1000	6
111/10/25/N	100	25	32	20	10	14X70	1080	6



Art.	Ø	A	B	C	D	E	Peso(g)	Conf.
112/5/17	50	17	19	8	4,5	10X45	210	25
112/6/17	60	17	19	8	4,5	10X45	300	20
112/7/20	70	20	32	12	6,5	14X70	480	12
112/8/20	80	20	32	12	6,5	14X70	650	10
112/9/20	90	20	32	12	6,5	14X70	810	10
112/10/20	100	20	32	12	6,5	14X70	1.000	8
112/12/20	120	20	32	12	6,5	14X70	1.500	6
112/14/20	140	20	32	12	6,5	14X70	2.100	6
112/16/20	160	20	32	12	6,5	14X70	2.800	6

Ruota con bullone

Art. 110 - 111 - 112 - 117 - 2 cuscinetti

🇬🇧 Wheel with bolt

🇫🇷 Galet avec boulon

🇪🇸 Rueda con tornillo

🇩🇪 Schiebetore Rolle aus verzinktem Stahl oder Edelstahl mit Bolzen und zwei Kugellagern

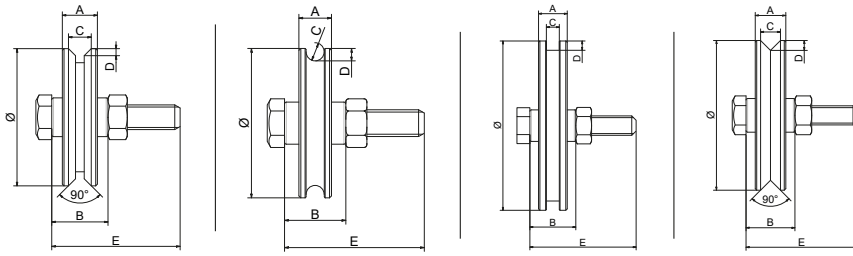

Materiale: Acciaio Zincato / Cataforesi / Nylon / Inox



2 Cuscinetti schermati

2 Ball bearings | 2 Roulements | 2 Rodamientos

**N.B. Per ordinare la versione Cataforesi aggiungere la lettera "C" alla fine del codice Es: 111/5/17/C**  
Le versioni nylon sono indicate con la lettera "N" finale.

INOX  NYLON

To order the Cataphoresis model, add "C" at the end of the code. Ex.: 110/5/17/C  
The nylon versions are indicated with the final letter "N".



Art.	Ø	A	B	C	D	E	Peso(g)	Conf.
110/8/25/2	80	26	44	20	7,5	14X70	800	8
110/9/25/2	90	26	44	20	7,5	14X70	1.000	8
110/10/25/2	100	26	44	20	7,5	14X70	1.300	6
110/12/25/2	120	26	44	20	7,5	14X70	1.400	6
110/10/32/2	100	32	44	20	7,5	14X70	1.570	4
110/12/32/2	120	32	44	20	7,5	14X70	2.360	4
110/14/32/2	140	32	44	20	7,5	16X70	3.270	4
110/16/32/2	160	32	44	20	7,5	16X70	4.340	4
110/20/32/2	200	32	44	20	7,5	16X70	7.000	2
110/25/32/2	250	32	44	20	7,5	18X90	11.690	2
1110/14/32/2	140	32	44	20	7,5	14x70	3.270	4



Art.	Ø	A	B	C	D	E	Peso(g)	Conf.
111/8/25/2	80	26	44	20	10	14X70	800	8
111/9/25/2	90	26	44	20	10	14X70	1.000	8
111/10/25/2	100	26	44	20	10	14X70	1.300	6
111/12/25/2	120	26	44	20	10	14X70	1.400	6
111/10/32/2	100	32	44	20	10	14X70	1.500	4
111/12/32/2	120	32	44	20	10	14X70	2.250	4
111/14/32/2	140	32	44	20	10	16X70	3.140	4
111/16/32/2	160	32	44	20	10	16X70	4.200	4
111/20/32/2	200	32	44	20	10	16X70	6.860	2
111/25/32/2	250	32	44	20	10	18X90	11.370	2
1111/14/32/2	140	32	44	20	10	14X70	2.600	4



Art.	Ø	A	B	C	D	E	Peso(g)	Conf.
117/8/25/2	80	26	44	20	10	14X70	800	8
117/9/25/2	90	26	44	20	10	14X70	1.000	8
117/10/25/2	100	26	44	20	10	14X70	1.300	6
117/12/25/2	120	26	44	20	10	14X70	1.400	6
117/10/32/2	100	32	44	20	10	14X70	1.570	4
117/12/32/2	120	32	44	20	10	14X70	2.360	4
117/14/32/2	140	32	44	20	10	16X70	3.270	4
117/16/32/2	160	32	44	20	10	16X70	4.340	4
117/20/32/2	200	32	44	20	10	16X70	7.000	2
117/25/32/2	250	32	44	20	10	18X90	11.690	2
1117/14/32/2	140	32	44	20	10	14x70	2.650	4





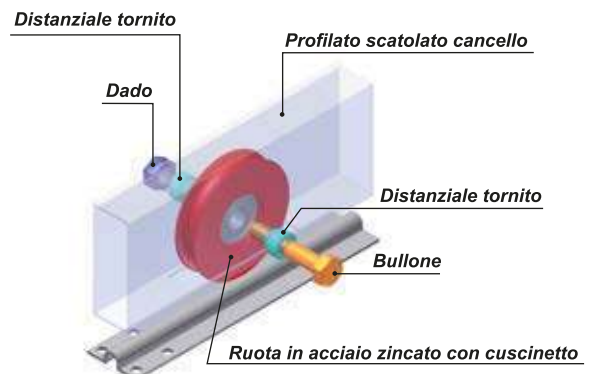

Art.	Ø	A	B	C	D	E	Peso(g)	Conf.
112/10/32/2	100	32	44	20	10	14X70	1.450	4
112/12/32/2	120	32	44	20	10	14X70	1.800	4
112/14/32/2	140	32	44	20	10	14X70	2.500	4
112/16/32/2	160	32	44	20	10	16X70	3.050	4
112/20/32/2	200	32	44	20	10	16X70	5.300	2
112/25/32/2	250	32	44	20	10	18X90	7.500	2



## Art. 220 - 221 - 222 - 227 - 1 cuscinetto

## Ruota estraibile con supporto a piastre

 Galvanized extractable steel wheel with plates support 
  Galet extractible en acier zingué avec support à platines 
  Rueda extraible con placa de soporte a tornillar o soldar 
  Schiebetore Rolle mit herausziehbarer Stützplatte und einem Kugellagern

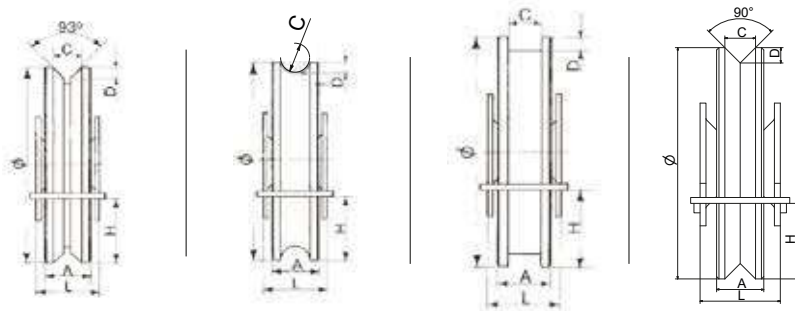

Materiale: Acciaio Zincato / Cataforesi / Nylon / Inox

 1 Cuscinetto schermato | 1 Ball bearing | 1 Roulement | 1 Rodamiento

**N.B. Per ordinare la versione Cataforesi aggiungere la lettera "C" alla fine del codice Es: 111/5/17/C**

Le versioni nylon sono indicate con la lettera "N" finale.

To order the Cataphoresis model, add "C" at the end of the code. Ex.: 110/5/17/C

The nylon versions are indicated with the final letter "N".

INOX

NYLON



Art.	Ø	A	C	D	H	L	Peso(g)	Conf.
220/7/20	70	20	13	4	17	32	590	20
220/8/20	80	20	13	4	23	32	760	20
220/9/20	90	20	13	4	28	32	930	12
220/10/20	100	20	13	4	32	32	1.115	12
220/12/20	120	20	13	4	35	32	1.815	8
220/14/20	140	20	13	4	48	32	2.440	6
220/8/25	80	25	20	7,5	23	32	790	20
220/10/25	100	25	20	7,5	32	32	1.250	12
220/12/25	120	25	20	7,5	35	32	2.070	8
220/14/25	140	25	20	7,5	48	32	2.150	6



Art.	Ø	A	C	D	H	L	Peso	Conf.
221/7/20	70	20	16	8	17	32	580	20
221/8/20	80	20	16	8	23	32	740	20
221/9/20	90	20	16	8	28	32	930	12
221/10/20	100	20	16	8	32	32	1.130	12
221/12/20	120	20	16	8	35	32	1.810	8
221/14/20	140	20	16	8	48	32	2.420	6
221/8/25	80	25	20	10	23	32	720	20
221/10/25	100	25	20	10	32	32	1.190	12
221/12/25	120	25	20	10	35	32	1.940	8
221/14/25	140	25	20	10	48	32	2.660	6
221/8/25/N	80	25	20	10	23	32	680	6
221/9/25/N	90	25	20	10	28	32	890	6
221/10/25/N	100	25	20	10	32	32	1.140	6



Art.	Ø	A	C	D	H	L	Peso(g)	Conf.
227/7/20	70	20	13	6,5	17	32	590	20
227/8/20	80	20	13	6,5	23	32	760	20
227/9/20	90	20	13	6,5	28	32	930	12
227/10/20	100	20	13	6,5	32	32	1.115	12
227/12/20	120	20	13	6,5	35	32	1.815	8
227/14/20	140	20	13	6,5	48	32	2.440	6
227/8/25	80	25	20	10	23	32	790	20
227/10/25	100	25	20	10	32	32	1.250	12
227/12/25	120	25	20	10	35	32	2.070	8
227/14/25	140	25	20	10	48	32	2.150	6



Art.	Ø	A	C	D	H	L	Peso(g)	Conf.
222/7/20	70	20	12	6,5	17	32	560	20
222/8/20	80	20	12	6,5	23	32	710	20
222/9/20	90	20	12	6,5	28	32	900	12
222/10/20	100	20	12	6,5	32	32	1.110	12
222/12/20	120	20	12	6,5	35	32	1.760	8
222/14/20	140	20	12	6,5	48	32	2.360	6

**Ruota estraibile con supporto a piastra**

Art. 220 - 221 - 222 - 227 - 2 cuscinietti

🇬🇧 Galvanized or stainless steel wheel with bolt 
 🇫🇷 Galet en acier zingué ou inox avec boulon 
 🇪🇸 Rueda extraíble con placa de soporte en acero cincado o inox 
 🇩🇪 Schiebetore Rolle mit herausziehbarer Stützplatte und zwei Kugellager

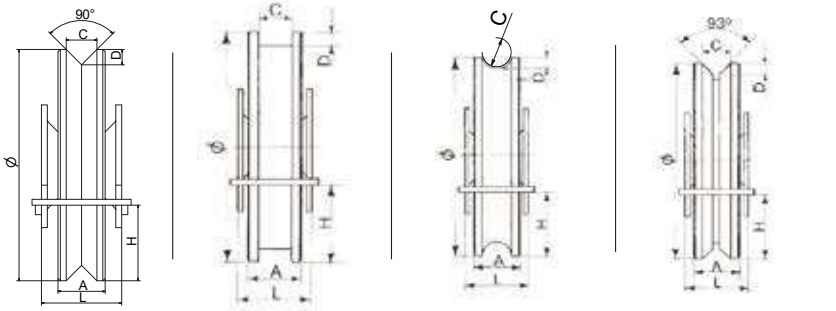

Materiale: Acciaio Zincato / Cataforesi / Nylon / Inox



2 Cuscinietti schermati

2 Ball bearings | 2 Roulements | 2 Rodamientos

**N.B. Per ordinare la versione Cataforesi aggiungere la lettera "C" alla fine del codice Es: 111/5/17/C**  
 Le versioni nylon sono indicate con la lettera "N" finale.

INOX  NYLON

To order the Cataphoresis model, add "C" at the end of the code. Ex.: 110/5/17/C  
 The nylon versions are indicated with the final letter "N".



Art.	Ø	A	C	D	H	L	Peso(g)	Conf.
220/10/32/2	100	32	20	7,5	32	44	1.680	8
220/12/32/2	120	32	20	7,5	35	44	2.650	6
220/14/32/2	140	32	20	7,5	45	44	3.530	4



Art.	Ø	A	C	D	H	L	Peso(g)	Conf.
221/10/32/2	100	32	20	10	32	44	1.610	8
221/12/32/2	120	32	20	10	35	44	2.540	6
221/14/32/2	140	32	20	10	45	44	3.410	4



Art.	Ø	A	C	D	H	L	Peso(g)	Conf.
227/10/32/2	100	32	20	10	32	44	1.680	8
227/12/32/2	120	32	20	10	35	44	2.650	6
227/14/32/2	140	32	20	10	45	44	3.530	4





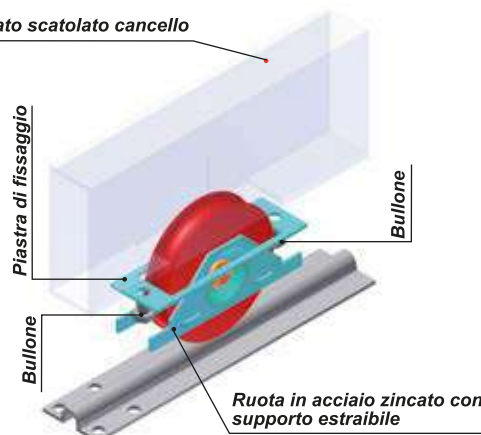

Art.	Ø	A	C	D	H	L	Peso(g)	Conf.
222/10/32/2	100	32	20	10	32	44	1.520	8
222/12/32/2	120	32	20	10	35	44	1.970	6
222/14/32/2	140	32	20	10	45	44	2.720	4

Profilato scatolato cancello



## Art. 120 - 121 - 122 - 127 - 1 cuscinetto

## Ruota con supporto chiuso in acciaio zincato

 Galvanized steel roller with closed bracket 
  Galet extractible en acier zingué avec support à platines 
  Rueda extraíble con placa de soporte a tornillar o soldar 
  Schiebetore Rolle mit geschlossener Stützplatte aus verzinktem Stahl und einem Kugellager

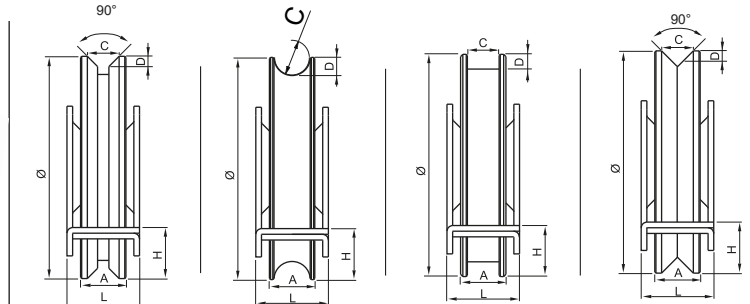

Materiale: Acciaio Zincato / Cataforesi / Nylon / Inox



1 Cuscinetto schermato | 1 Ball bearing | 1 Roulement | 1 Rodamiento

**N.B. Per ordinare la versione Cataforesi aggiungere la lettera "C" alla fine del codice Es: 111/5/17/C**  
**Le versioni nylon sono indicate con la lettera "N" finale.**

INOX

NYLON

**To order the Cataphoresis model, add "C" at the end of the code. Ex.: 110/5/17/C**  
**The nylon versions are indicated with the final letter "N".**



Art.	Ø	A	C	D	H	L	Peso(g)	Conf.
120/7/20	70	20	13	4	20	32	620	20
120/8/20	80	20	13	4	25	32	770	20
120/9/20	90	20	13	4	20	32	960	12
120/10/20	100	20	13	4	25	32	1.180	12
120/12/20	120	20	13	4	29	32	1.888	8
120/14/20	140	20	13	4	29	32	2.478	6
120/16/20	160	20	13	4	32	32	3.228	4
120/8/25	80	25	20	7,5	25	32	800	20
120/10/25	100	25	20	7,5	25	32	1.280	12
120/12/25	120	25	20	7,5	29	32	2.088	8
120/14/25	140	25	20	7,5	29	32	2.780	6
120/16/25	160	25	20	7,5	32	32	3.670	4



Art.	Ø	A	C	D	H	L	Peso(g)	Conf.
121/7/20	70	20	16	8	20	32	530	20
121/8/20	80	20	16	8	25	32	690	20
121/9/20	90	20	16	8	20	32	860	12
121/10/20	100	20	16	8	25	32	1.070	12
121/12/20	120	20	16	8	29	32	1.748	8
121/14/20	140	20	16	8	29	32	2.238	6
121/16/20	160	20	16	8	32	32	3.028	4
121/8/25	80	25	20	10	25	32	730	20
121/10/25	100	25	20	10	25	32	1.170	12
121/12/25	120	25	20	10	29	32	1.970	8
121/14/25	140	25	20	10	29	32	2.650	6
121/16/25	160	25	20	10	32	32	3.500	4
121/8/25/N	80	25	20	10	25	32	760	6
121/9/25/N	90	25	20	10	20	32	970	6
121/10/25/N	100	25	20	10	25	32	1220	6



Art.	Ø	A	C	D	H	L	Peso(g)	Conf.
127/7/20	70	20	13	6,5	20	32	620	20
127/8/20	80	20	13	6,5	25	32	770	20
127/9/20	90	20	13	6,5	20	32	960	12
127/10/20	100	20	13	6,5	25	32	1.220	12
127/12/20	120	20	13	6,5	29	32	1.888	8
127/14/20	140	20	13	6,5	29	32	2.478	6
127/16/20	160	20	13	6,5	32	32	3.228	4
127/8/25	80	25	20	10	25	32	800	20
127/10/25	100	25	20	10	25	32	1.280	12
127/12/25	120	25	20	10	29	32	2.088	8
127/14/25	140	25	20	10	29	32	2.780	6
127/16/25	160	25	20	10	32	32	3.670	4



Art.	Ø	A	C	D	H	L	Peso(g)	Conf.
122/7/20	70	20	12	6,5	20	32	580	12
122/8/20	80	20	12	6,5	25	32	750	20
122/9/20	90	20	12	6,5	20	32	920	12
122/10/20	100	20	12	6,5	25	32	1.130	12
122/12/20	120	20	12	6,5	29	32	1.838	8
122/14/20	140	20	12	6,5	29	32	2.388	6
122/16/20	160	20	12	6,5	32	32	2.540	4

**Ruota con supporto chiuso in acciaio zincato**

**Art. 120 - 121 - 122 - 127 - 2 cuscinetti**

Galvanized extractable steel wheel with plates support 
 Galet extractible en acier zingué avec support à platines 
 Rueda extraíble con placa de soporte a tornillar o soldar 
 Schiebetore Rolle mit geschlossener Stützplatte aus verzinktem Stahl und einem Kugellager

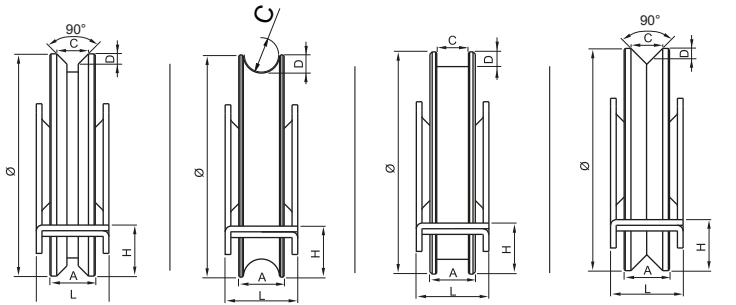

Materiale: Acciaio Zincato / Cataforesi / Nylon / Inox



2 Cuscinetti schermati | 2 Ball bearings | 2 Roulements | 2 Rodamientos

**N.B. Per ordinare la versione Cataforesi aggiungere la lettera "C" alla fine del codice Es: 111/5/17/C**

INOX

NYLON

**Le versioni nylon sono indicate con la lettera "N" finale.**

**To order the Cataphoresis model, add "C" at the end of the code. Ex.: 110/5/17/C**

**The nylon versions are indicated with the final letter "N".**



Art.	Ø	A	C	D	H	L	Peso(g)	Conf.
120/8/25/2	80	26	20	7,5	25	35	870	20
120/9/25/2	90	26	20	7,5	25	35	1.080	12
120/10/25/2	100	26	20	7,5	25	35	1.300	12
120/12/25/2	120	26	20	7,5	29	35	1.500	8
120/10/32/2	100	32	20	7,5	25	44	1.710	8
120/12/32/2	120	32	20	7,5	29	44	2.710	6
120/14/32/2	140	32	20	7,5	29	44	3.610	4
120/16/32/2	160	32	20	7,5	32	44	4.690	2



Art.	Ø	A	C	D	H	L	Peso(g)	Conf.
121/8/25/2	80	26	20	10	25	35	800	20
121/9/25/2	90	26	20	10	25	35	1.000	12
121/10/25/2	100	26	20	10	25	35	1.300	12
121/12/25/2	120	26	20	10	29	35	1.500	8
121/10/32/2	100	32	20	10	25	44	1.640	8
121/12/32/2	120	32	20	10	29	44	2.600	6
121/14/32/2	140	32	20	10	29	44	3.490	4
121/16/32/2	160	32	20	10	32	44	4.550	2



Art.	Ø	A	C	D	H	L	Peso(g)	Conf.
127/8/25/2	80	26	20	10	25	35	870	20
127/9/25/2	90	26	20	10	25	35	1.080	12
127/10/25/2	100	26	20	10	25	35	1.300	12
127/12/25/2	120	26	20	10	29	35	1.500	8
127/10/32/2	100	32	20	10	25	44	1.710	8
127/12/32/2	120	32	20	10	29	44	2.710	6
127/14/32/2	140	32	20	10	29	44	3.610	4
127/16/32/2	160	32	20	10	32	44	4.690	2





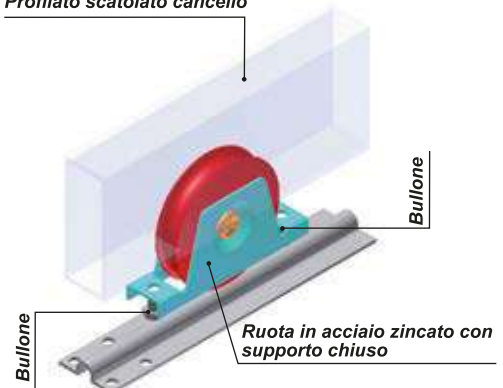

Art.	Ø	A	C	D	H	L	Peso(g)	Conf.
122/10/32/2	100	32	20	10	25	44	1.530	8
122/12/32/2	120	32	20	10	29	44	2.504	6
122/14/32/2	140	32	20	10	29	44	2.504	4
122/16/32/2	160	32	20	10	32	44	3.500	2

Profilato scatolato cancello



## Art. 130 - 131 - 132 - 137 - 1 cuscinetto

## Ruota con supporto aperto in acciaio zincato

 Galvanized steel wheel with open bracket 
  Galet en acier zingué avec support ouvert 
  Rueda en acero cincado con soporte abierto  
 Schiebetore Rolle aus verzinktem Stahl mit geöffneter Stützplatte und einem Kugellager

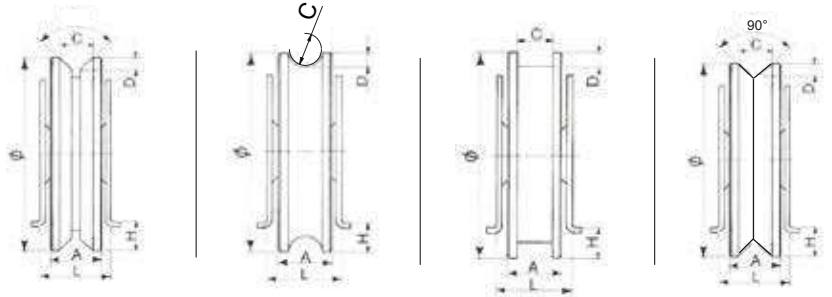

Materiale: Acciaio Zincato / Acciaio Inox



1 Cuscinetto schermato | 1 Ball bearing | 1 Roulement | 1 Rodamiento

**N.B. Per ordinare la versione Cataforesi aggiungere la lettera "C" alla fine del codice Es: 111/5/17/C**

**Le versioni nylon sono indicate con la lettera "N" finale.**

**To order the Cataphoresis model, add "C" at the end of the code. Ex.: 110/5/17/C**

**The nylon versions are indicated with the final letter "N".**

INOX 

NYLON 



Art.	Ø	A	C	D	H	L	Peso(g)	Conf.
130/6/17	60	17	11	4	8,5	25	290	24
130/8/20	80	20	13	4	12	33	800	20
130/9/20	90	20	13	4	17	33	1.000	12
130/10/20	100	20	13	4	22	33	1.200	12
130/12/20	120	20	13	4	18	33	2.070	8
130/14/20	140	20	13	4	28	33	2.650	6
130/8/25	80	25	20	7,5	12	33	840	20
130/10/25	100	25	20	7,5	22	33	1.300	12
130/12/25	120	25	20	7,5	18	33	2.200	8
130/14/25	140	25	20	7,5	28	33	2.900	6
1130/8/20	80	20	13	4	12	33	800	12
1130/10/20	100	20	13	4	22	33	1.200	12



Art.	Ø	A	C	D	H	L	Peso(g)	Conf.
131/6/17	60	17	9,5	6,5	8,5	25	260	24
131/8/20	80	20	16	8	12	33	780	20
131/9/20	90	20	16	8	17	33	980	12
131/10/20	100	20	16	8	22	33	1.190	12
131/12/20	120	20	16	8	18	33	2.000	8
131/14/20	140	20	16	8	28	33	2.600	6
131/8/25	80	25	20	10	12	33	750	20
131/10/25	100	25	20	10	22	33	1.210	12
131/12/25	120	25	20	10	18	33	2.120	8
131/14/25	140	25	20	10	28	33	2.460	6
1131/8/20	80	20	12	8	12	33	780	20
1131/10/20	100	20	12	8	22	33	1.190	12
131/8/25/N	80	25	20	10	12	33	780	20
131/9/25/N	90	25	20	10	22	33	1.000	12
131/10/25/N	100	25	20	10	18	33	1.250	12







Art.	Ø	A	C	D	H	L	Peso(g)	Conf.
137/6/17	60	17	11	5,5	8,5	25	290	24
137/8/20	80	20	13	6,5	12	33	800	20
137/9/20	90	20	13	6,5	17	33	1.000	12
137/10/20	100	20	13	6,5	22	33	1.200	12
137/12/20	120	20	13	6,5	18	33	2.070	8
137/14/20	140	20	13	6,5	28	33	2.650	6
137/8/25	80	25	20	10	12	33	840	20
137/10/25	100	25	20	10	22	33	1.300	12
137/12/25	120	25	20	10	18	33	2.200	8
137/14/25	140	25	20	10	28	33	2.900	6
1137/8/20	80	20	13	6,5	12	33	800	20
1137/10/20	100	20	13	6,5	22	33	1.200	12



Art.	Ø	A	C	D	H	L	Peso(g)	Conf.
132/6/17	60	17	8	4,5	8,5	25	260	24
132/8/20	80	20	12	6,5	12	33	780	20
132/9/20	90	20	12	6,5	17	33	980	12
132/10/20	100	20	12	6,5	22	33	1.190	12
132/12/20	120	20	12	6,5	18	33	2.000	8
132/14/20	140	20	12	6,5	28	33	2.600	6

**Ruota con supporto aperto in acciaio zincato**

**Art. 130 - 131 - 132 - 137 - 2 cuscinetti**

 Galvanized steel wheel with open bracket 
  Galet en acier zingué avec support ouvert 
  Rueda en acero cincado con soporte abierto  
 Schiebetore Rolle aus verzinktem Stahl mit geöffneter Stützplatte und zwei Kugellager

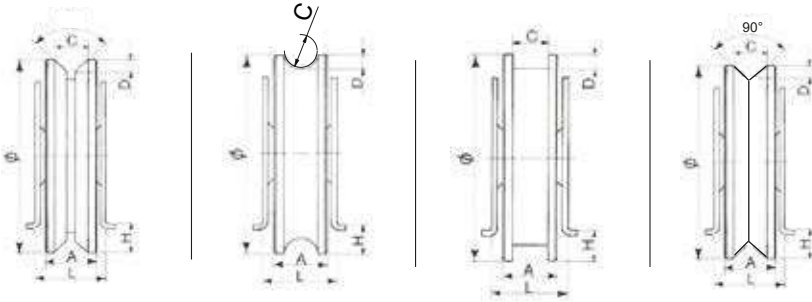

Materiale: Acciaio Zincato / Cataforesi / Nylon / Inox



**2 Cuscinetti schermati** 2 Ball bearings | 2 Roulements | 2 Rodamientos

**N.B. Per ordinare la versione Cataforesi aggiungere la lettera "C" alla fine del codice Es: 111/5/17/C**  
 Le versioni nylon sono indicate con la lettera "N" finale.  
 To order the Cataphoresis model, add "C" at the end of the code. Ex.: 110/5/17/C  
 The nylon versions are indicated with the final letter "N".

INOX  NYLON 



Art.	Ø	A	C	D	H	L	Peso(g)	Conf.
130/10/32/2	100	32	20	7,5	22	44	1.730	8
130/12/32/2	120	32	20	7,5	18	44	2.830	6
130/14/32/2	140	32	20	7,5	28	44	3.710	4



Art.	Ø	A	C	D	H	L	Peso(g)	Conf.
131/10/32/2	100	32	20	10	22	44	1.660	8
131/12/32/2	120	32	20	10	18	44	2.720	6
131/14/32/2	140	32	20	10	28	44	3.590	4



Art.	Ø	A	C	D	H	L	Peso(g)	Conf.
137/10/32/2	100	32	20	10	22	44	1.730	8
137/12/32/2	120	32	20	10	18	44	2.830	6
137/14/32/2	140	32	20	10	28	44	3.710	4



Art.	Ø	A	C	D	H	L	Peso(g)	Conf.
132/10/32/2	100	32	20	10	22	44	1.600	8
132/12/32/2	120	32	20	10	18	44	2.200	6
132/14/32/2	140	32	20	10	28	44	2.920	4

Profilato scatolato cancello

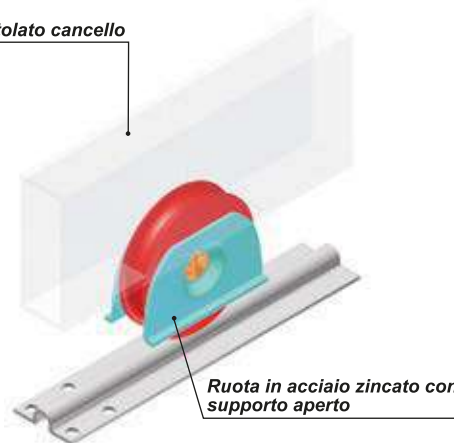





Ruota in acciaio zincato con supporto aperto



## Art. 140 - 141 - 142 - 147 1 - 2 cuscinetti

## Ruota con supporto fisso in acciaio zincato

 Galvanized steel wheel with fixed bracket 
  Galet en acier zingué avec support fixe 
  Rueda en acero cincado con soporte fijo  
 Schiebetore Rolle mit fester Stützplatte aus verzinktem Stahl und einem Kugellager



Materiale: Acciaio Zincato

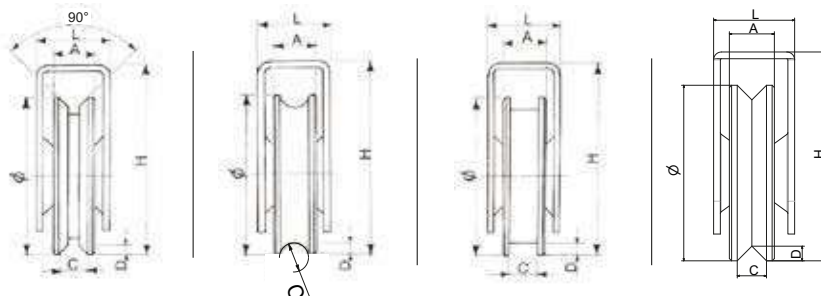

 1 Cuscinetto schermato | 1 Ball bearing | 1 Roulement | 1 Rodamiento

**N.B. Per ordinare la versione Cataforesi aggiungere la lettera "C" alla fine del codice Es: 111/5/17/C**  
**Le versioni nylon sono indicate con la lettera "N" finale**  
**To order the Cataphoresis model, add "C" at the end of the code. Ex.: 110/5/17/C**  
**The nylon versions are indicated with the final letter "N"**



Art.	Ø	A	C	D	H	L	Peso(g)	Conf.
140/7/20	70	20	13	4	90	36	750	12
140/8/20	80	20	13	4	95	36	920	15
140/9/20	90	20	13	4	100	36	1.100	12
140/10/20	100	20	13	4	105	36	1.350	12
140/8/25	80	25	20	7,5	95	36	930	15
140/10/25	100	25	20	7,5	105	36	1.400	12



Art.	Ø	A	C	D	H	L	Peso(g)	Conf.
141/7/20	70	20	16	8	90	36	730	15
141/8/20	80	20	16	8	95	36	890	15
141/9/20	90	20	16	8	100	36	1.090	12
141/10/20	100	20	16	8	105	36	1.300	12
141/8/25	80	25	20	10	95	36	850	15
141/10/25	100	25	20	10	105	36	1.310	12



Art.	Ø	A	C	D	H	L	Peso(g)	Conf.
147/7/20	70	20	13	6,5	90	36	750	12
147/8/20	80	20	13	6,5	95	36	920	15
147/9/20	90	20	13	6,5	100	36	1.100	12
147/10/20	100	20	13	6,5	105	36	1.350	12
147/8/25	80	25	20	10	95	36	930	15
147/10/25	100	25	20	10	105	36	1.400	12



Art.	Ø	A	C	D	H	L	Peso(g)	Conf.
142/7/20	70	20	12	6,5	90	36	720	15
142/8/20	80	20	12	6,5	95	36	850	15
142/9/20	90	20	12	6,5	100	36	1.060	12
142/10/20	100	20	12	6,5	105	36	1.240	12

 2 Cuscinetti schermati | 2 Ball bearings | 2 Roulements | 2 Rodamientos



Art.	Ø	A	C	D	H	L	Peso(g)	Conf.
140/10/32/2	100	32	20	7,5	102	41	1.800	8



Art.	Ø	A	C	D	H	L	Peso(g)	Conf.
141/10/32/2	100	32	20	10	102	41	1.730	8



Art.	Ø	A	C	D	H	L	Peso(g)	Conf.
147/10/32/2	100	32	20	10	102	41	1.800	8



Art.	Ø	A	C	D	H	L	Peso(g)	Conf.
142/10/32/2	100	32	20	10	102	41	1.730	8

**Ruota in acciaio zincato con ingrassatore**

**Art. 106 - 107 - 100 - 101 - 102 - 1 / 2 cuscinetti**

🇬🇧 Galvanized steel wheel with lubricator

🇫🇷 Galet en acier zingué avec pivot graisseur

🇪🇸 Rueda en acero cincado con lubricador

🇩🇪 Schiebetore Rolle aus verzinktem Stahl mit Schmiernippel und einem Kugellager

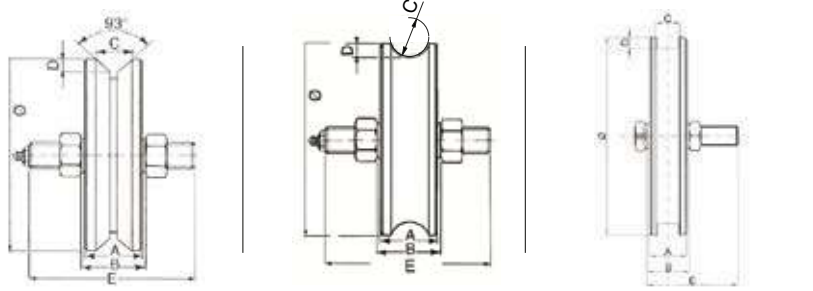

Materiale: Acciaio Zincato



**1 Cuscinetto schermato** | 1 Ball bearing | 1 Roulement | 1 Rodamiento

**N.B. Per ordinare la versione Cataforesi aggiungere la lettera "C" alla fine del codice Es: 111/5/17/C**  
 Le versioni nylon sono indicate con la lettera "N" finale.  
 To order the Cataphoresis model, add "C" at the end of the code. Ex.: 110/5/17/C  
 The nylon versions are indicated with the final letter "N".

INOX

NYLON



Art.	Ø	A	B	C	D	E	Peso(g)	Conf.
106/8/25	80	25	44	20	7,5	16x80	790	8
106/10/25	100	25	44	20	7,5	16x80	1.300	6
106/12/25	120	25	44	20	7,5	16x80	1.930	6
106/14/25	140	25	44	20	7,5	16x80	2.700	6



Art.	Ø	A	B	C	D	E	Peso	Conf.
107/8/25	80	25	44	20	10	16x80	790	8
107/10/25	100	25	44	20	10	16x80	1.300	6
107/12/25	120	25	44	20	10	16x80	1.930	6
107/14/25	140	25	44	20	10	16x80	2.700	6



**2 Cuscinetti schermati** | 2 Ball bearings | 2 Roulements | 2 Rodamientos



Art.	Ø	A	B	C	D	E	Peso(g)	Conf.
100/12/38	120	38	44	26	10,5	18X90	2.720	4
100/14/38	140	38	44	26	10,5	18X90	3.550	4
100/16/38	160	38	44	26	10,5	18X90	5.030	4
100/20/38	200	38	44	26	10,5	18X90	8.310	2
100/25/38	250	38	44	26	10,5	18X90	13.050	2



Art.	Ø	A	B	C	D	E	Peso(g)	Conf.
101/12/38	120	38	44	25	12	18X90	2.570	4
101/14/38	140	38	44	25	12	18X90	3.400	4
101/16/38	160	38	44	25	12	18X90	4.870	4
101/20/38	200	38	44	25	12	18X90	8.060	2
101/25/38	250	38	44	25	12	18X90	12.840	2

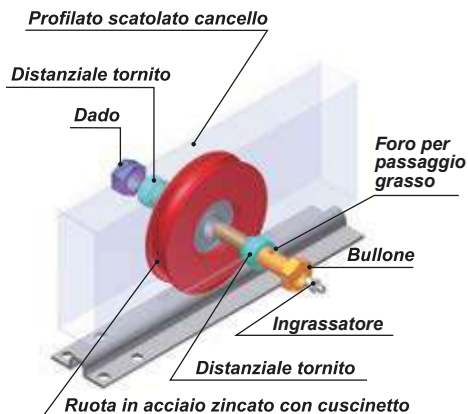

Art.	Ø	A	B	C	D	E	Peso(g)	Conf.
102/12/38	120	38	44	25	12	18X90	2.450	4
102/14/38	140	38	44	25	12	18X90	3.200	4
102/16/38	160	38	44	25	12	18X90	3.900	4
102/20/38	200	38	44	25	12	18X90	5.900	2
102/25/38	250	38	44	25	12	18X90	9.400	2

## Art. 99

## Ruota con piastre laterali in acciaio zincato, gola O

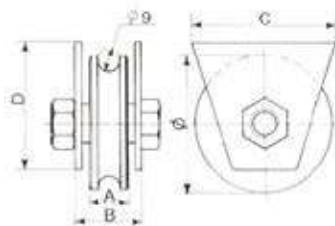

- Galvanized steel wheel with side plates, O groove
- Galet en acier zingué avec flasques latérales, gorge O
- Rueda en acero cincado con soportes laterales, canal O
- O-Rille Schiebetore Rolle mit Seitenplatten aus verzinktem Stahl

Materiale: Acciaio Zincato

Art.	Ø	A	B	C	D	Peso(g)	Conf.
99/5	50	17	27	62	55	350	25
99/6	60	17	27	62	55	450	25
99/7	70	17	27	68	65	550	15
99/8	80	17	27	68	65	700	15



## Art. 148

## Ruota in acciaio zincato per basculante

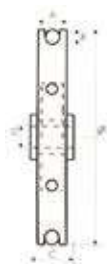

- Galvanized steel wheel for bascule doors
- Galet en acier zingué pour portes à bascule
- Rueda para basculante de acero cincado
- Schiebetore Rolle aus verzinktem Stahl für Kipp Tore

Materiale: Acciaio Zincato

Art.	Ø	A	B	C	D	D Fune	Peso(g)	Conf.
148/8	80	16	6	20	12	6	490	15
148/9	90	16	6	20	12	6	610	10
148/10	100	16	6	20	12	6	790	10
148/12	120	16	8	20	12	8	1.190	8



## Art. 3992

## Cuscinetto ricoperto in nylon

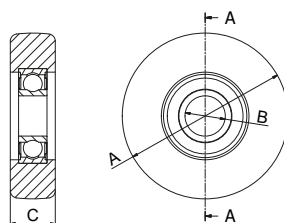

- Nylon ball bearing
- Roulement en nylon
- Rodamiento recubierto en nylon
- Kugellager mit Nylon überzogen

Materiale: Nylon

Art.	A	B	Spessore	Peso(g)	Conf.
3992.1	65	17	20	100	20
3992.2	70	17	18,5	110	15
3992.3	65	17	16	100	20
3992.4	80	17	22	150	12

## Art. 150

## Rullo guida superiore regolabile in acciaio zincato con cuscinetto interno



- Galvanized steel top roller with ball bearing
- Rouleau supérieur réglable en acier zingué avec roulement
- Guía superior regulable en acero cincado con rodamiento interno
- Obere einstellbare Führungsrolle aus verzinktem Stahl mit Innenkugellager

Materiale: Acciaio Zincato

Art.	A	B	C	D	E	Peso(g)	Conf.
150/42	42	26	18	12	56-70	270	25
150/52	52	26	18	12	56-70	370	25



Rullo guida in acciaio zincato con cuscinetto esterno

Art. 155

Galvanized steel guide roller with ball bearing

Rouleau guide en acier zingué avec roulement

Guiador en acero cincado con rodamiento

Obere verstellbarer Führungsrolle aus verzinktem Stahl mit Außenkugellager

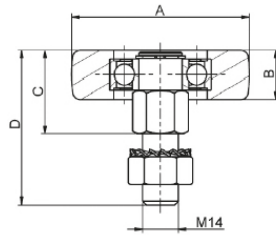

Materiale: Acciaio Zincato

Art.	A	B	C	D	Tipo	Peso(g)	Conf.
155/1	30	9	19	44,5	Cuscinetto	100	50
155/2	35	10	29	57	Cuscinetto	160	50
155/3	40	12	29	57	Cuscinetto	190	50
155/4	63	20	33	61	Nylon	80	25
155/5	70	19	32,5	60,5	Nylon	120	25
155/6	78	22	34	62	Nylon	170	25

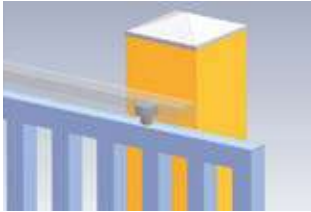

Rullo guida in acciaio zincato con oliva cilindrica, in nylon o in ottone

Art. 154

Galvanized steel guide cylindrical roller, nylon or brass

Rouleau guide en acier zingué avec olive cylindrique en nylon ou laiton

Guiador en acero cincado con rodillo cilíndrico de nylon o latón

Führungsrolle aus verzinktem Stahl mit zylindrische Rolle aus Nylon oder Messing

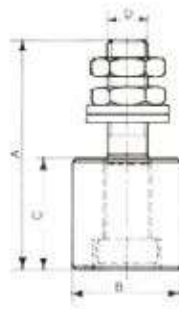

Materiale: Perno acciaio zincato

Per oliva in nylon bianca indicare dopo il codice la lettera "B" Es. 154/1.2B

To order white cylindrical roller, add "B" at the end of the code. Ex.: 154/1.2B

Art.	Var.	A	B	C	D	Peso(g)	Conf.	
154/1.2	Nylon	74	30	40	M14	160	30	
154/2.2	Nylon	81	40	40	M14	250	25	
154/3.2	Nylon	109	40	60	M16	290	30	
154/1.3	Ottone	74	30	40	M14	310	30	
154/2.3	Ottone	81	40	40	M14	520	25	
154/3.3	Ottone	109	40	60	M16	710	20	
INOX	1154/2.2	Nylon	81	40	40	M14	250	25
INOX	1154/2.3	Ottone	81	40	40	M14	520	25



Oliva bombata in nylon o in ottone

Art.157

Nylon or brass rounded roller

Olive bombée en nylon ou laiton

Guía con rodillo convexo de nylon o de latón

Gerundete Führungsrolle aus Nylon oder Messing

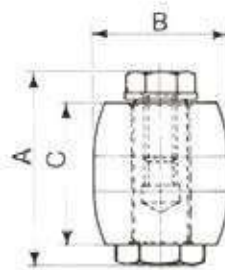

Materiale: Acciaio Zincato

Art.	Var.	A	B	C	D	Peso(g)	Conf.
157/2	Nylon	57	40	40	16	140	30
157/3	Ottone	57	40	40	16	400	30



## Art. 152

## Supporto guida superiore regolabile a 2 olive in nylon e in ottone



Materiale: Acciaio Zincato

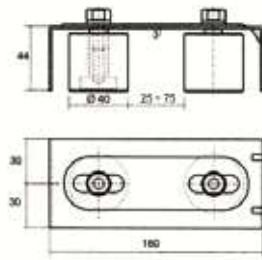

Art.	Var.	Peso(g)	Conf.
152/2	Nylon	580	12
152/3	Ottone	1.750	12

🇬🇧 2 Nylon or brass adjustable rollers top bracket

🇫🇷 Support supérieur à 2 olives réglables en nylon ou laiton

🇪🇸 Soporte guía superior regulable con 2 rodillos de nylon o latón

🇩🇪 Obere, verstellbare Torführungsplatte mit Führungsrollen aus Nylon oder Messing

**Per oliva in nylon bianca indicare dopo il codice la lettera "B" Es. 152/2B**

**To order white nylon roller add "B" at the end of the code. Ex.: 152/2B**

## Art. 153 - 1153

## Supporto guida superiore regolabile a 4 olive in nylon o in ottone



Materiale: Acciaio Zincato

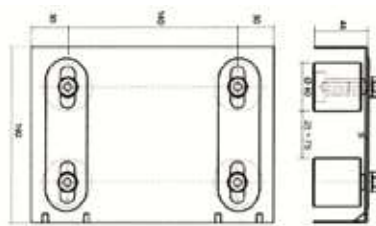

Art.	Var.	Peso(g)	Conf.
153/2	Nylon	1.580	4
153/3	Ottone	2.650	4
1153/2	Nylon	1.480	4
1153/3	Ottone	2.650	4

🇬🇧 4 Nylon or brass adjustable rollers top bracket

🇫🇷 Support supérieur à 4 olives réglables en nylon ou laiton

🇪🇸 Soporte guía superior regulable con 4 rodillos de nylon o latón

🇩🇪 Obere verstellbare Torführungsplatte mit vier Führungsrollen aus Nylon oder Messing

**Per oliva in nylon bianca indicare dopo il codice la lettera "B" Es. 153/2B**

**To order white nylon roller, add "B" at the end of the code. Ex.: 153/2B**

● INOX  
● INOX

## Art. 153/6 - 153/7

## Supporto superiore regolabile con 4 olive in nylon o in ottone



Materiale: Acciaio Zincato

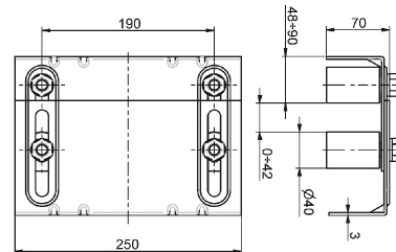

Art.	Var.	Peso(g)	Conf.
153/6	Nylon	2.990	4
153/7	Ottone	4.710	4

🇬🇧 Adjustable roller top guide with 4 nylon or brass rollers

🇫🇷 Support guide supérieure réglable avec 4 olives nylon ou laiton

🇪🇸 Soporte superior regulable con 4 rodillos de nylon o latón

🇩🇪 Obere verstellbare Torführungsplatte mit vier Führungsrollen aus Nylon oder Messing

## Art. 153/4 - 153/5

## Supporto superiore regolabile con 4 olive in nylon o in ottone



Materiale: Acciaio Zincato

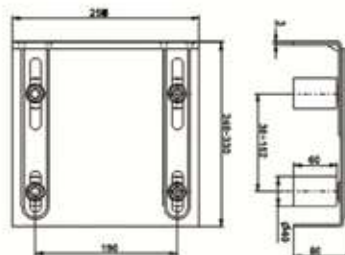

Art.	Var.	Peso(g)	Conf.
153/4	Nylon	3.600	4
153/5	Ottone	5.458	4

🇬🇧 Adjustable roller top guide with 4 nylon or brass rollers





🇫🇷 Support guide supérieure réglable avec 4 olives nylon ou laiton

🇪🇸 Soporte superior regulable con 4 rodillos de nylon o latón

🇩🇪 Obere verstellbare Torführungsplatte mit vier Führungsrollen aus Nylon oder Messing

Supporto guida superiore regolabile in acciaio zincato a 2 olive nylon o ottone

Art. 161

-  2 Nylon or brass rounded Ø40 rollers adjustable top bracket
-  Support supérieur réglable à 2 olives bombées Ø40 en nylon ou laiton
-  Soporte guía superior regulable de acero cincado con 2 rodillos Ø40 de nylon o de latón
-  Obere verstellbare Torführungsplatte aus verzinktem Stahl mit zwei Führungsrollen aus Nylon oder Messing

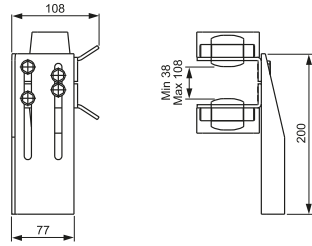





Materiale: Acciaio Zincato

Art.	Var.	Peso(g)	Conf.
161.2	Nylon	1.600	5
161.3	Ottone	2.150	5

Supporto guida superiore regolabile in acciaio zincato a 4 olive in nylon o ottone

Art. 160

-  4 Nylon or brass rounded Ø40 rollers adjustable top bracket
-  Support supérieur réglable à 4 olives bombées Ø40 en nylon ou laiton
-  Soporte guía superior regulable de acero cincado con 4 rodillos Ø40 de nylon o de latón
-  Obere verstellbare Torführungsplatte aus verzinktem Stahl mit vier Führungsrollen aus Nylon oder Messing

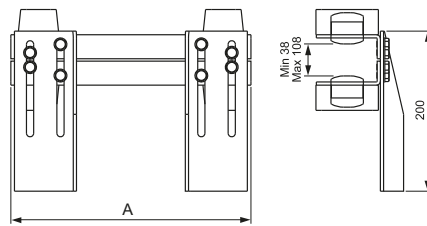





Materiale: Acciaio Zincato

Art.	Var.	A	Peso(g)	Conf.
160/30.2	Nylon	300	3.400	4
160/40.2	Nylon	400	4.500	4
160/50.2	Nylon	500	5.200	4
160/60.2	Nylon	600	5.900	4
160/30.3	Ottone	300	4.500	4
160/40.3	Ottone	400	5.500	4
160/50.3	Ottone	500	6.200	4
160/60.3	Ottone	600	7.000	4



Serratura a gancio in acciaio zincato o inox completa di cilindro

Art. 156 - 1156

-  Galvanized or stainless steel hook lock with cylinder
-  Serrure à crochet en acier zingué ou inox avec cylindre
-  Cerradura de gancho en acero cincado o inox
-  Schlosskasten mit Zylinder aus verzinktem Stahl oder Edelstahl

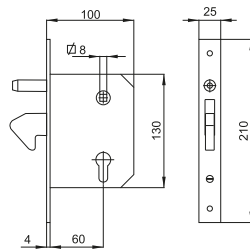





Materiale: Acciaio Zincato / Acciaio Inox

Art.	Var.	Peso(g)	Conf.
156/1	Con cilindro	1.290	1
156/2	Senza cilindro	1.110	1
INOX-1156.1	Con cilindro	1.300	1
INOX-1156.2	Senza cilindro	1.200	1



Scatola copriserratura in acciaio zincato

Art. 156/1

-  Galvanized steel cover-lock box
-  Boite couvre serrure en acier zingué
-  Caja cubre cerradura de acero cincado
-  Einbauschloss Kasten aus verzinktem Stahl

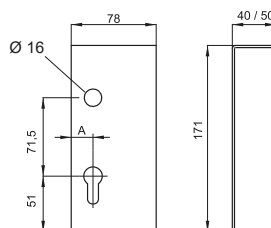

Materiale: Acciaio Zincato

Art.	A	x tubolare	Peso(g)	Conf.
156/1.10	10	50	560	9
156/1.20	20	40	560	9



## Art. 104.1

## Cremagliera per cancelli e portoni motorizzati, L 1mt. modulo 4

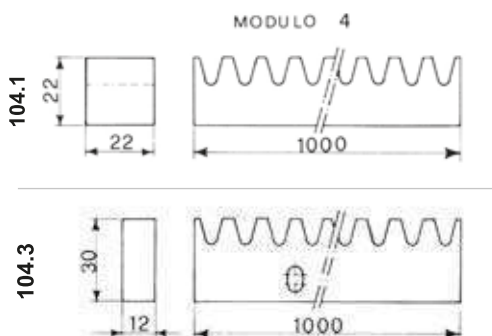

- Rack for motorised gates and industrial doors, 1 mt. length type 4
- Crémaillère pour grilles et portails motorisés, 1mt. longueur module 4
- Cremalleras para cancelas y portones motorizados, 1mt. larga modulo 4
- Zahnstange für motorisierten Tore 1 Meter Lang. Model 4

Materiale: Acciaio Zincato

Art.	Misura	Peso(g)	lmb.
104.1	22 x 22	3.020	6
104.3	30 x 12	2.350	10

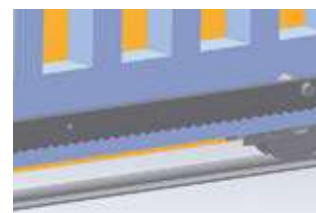

## Art.108.1

## Cremagliera rettangolare in tecnopolimero 28x20 modulo 4, L 1mt. attacco basso con viti

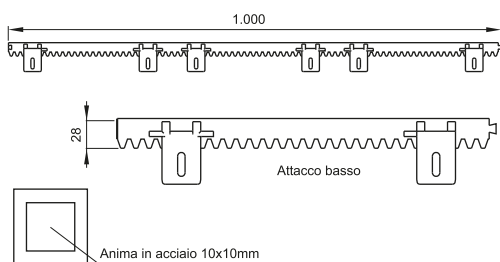

- Rectangular rack in polyamide 28x20 mod.4
- Crémaillère rectangulaire en polyamide 28x20 mod.4
- Cremallera rectangular 28x20 modulo 4, de poliamide
- Rechteckige Zahnstange aus Techno-Polymer 28x20, 1 Meter lang Model 4, mit Montagelöcher nach unten und Schrauben.

Materiale: Tecnopolimero

Art.	N. Attacchi	Peso	Conf.
108.1	6	1.420	4x1mt.

Con rondelle e viti di fissaggio autofilettanti DIN 7504

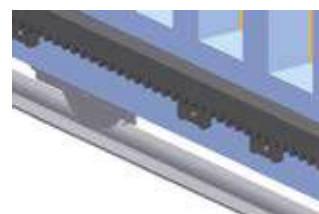

## Art. 105

## Attacco per cremagliera in acciaio zincato

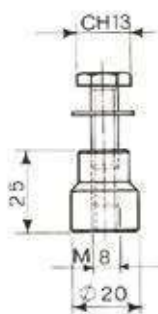

- Rack galvanized steel joint
- Jonction acier zingué pour crémaillère
- Travesano para cremalleras
- Distanzstück für Zahnstange aus verzinktem Stahl.

Materiale: Acciaio Zincato

Art.	Peso(g)	Conf.	lmb.
105	60	50	100

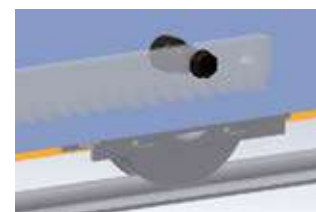

Arresto di finecorsa per cancelli scorrevoli in acciaio zincato

Art.151

Final galvanized steel stop for sliding gates

Butée en acier zingué pour grilles coulissantes

Tope para puerta corredera en acero cincado

Torendpuffer für Schiebtore aus verzinktem Stahl, zum Schweißen

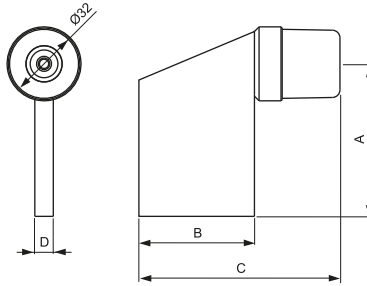

Materiale: Acciaio Zincato

Art.	A	B	C	D	Peso(g)	Conf.
151/1	66	50	86	8	320	25
151/2	87	70	108	10	560	25

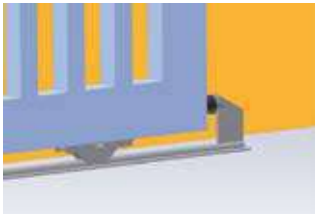

Final galvanized steel stop for sliding gates

Butée en acier zingué pour grilles coulissantes

Tope para puerta corredera en acero cincado

Torendpuffer für Schiebtore aus verzinktem Stahl, zum Anschrauben

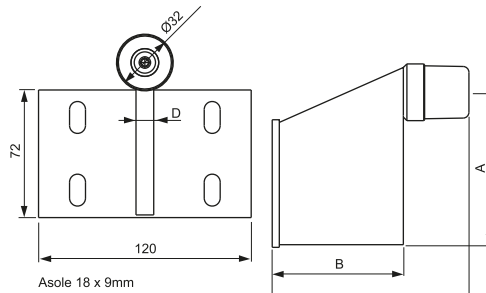

Materiale: Acciaio Zincato

Art.	A	B	C	D	Peso(g)	Conf.
151/1.1	73	50	90	8	580	10
151/2.1	87	70	110	10	820	10

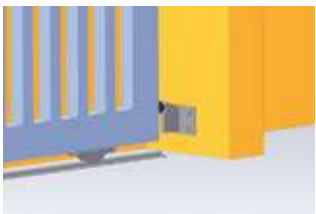

Final galvanized steel stop for sliding gates

Butée en acier zingué pour grilles coulissantes

Tope para puerta corredera en acero cincado

Torendpuffer für Schiebtore aus verzinktem Stahl, zum Anschrauben

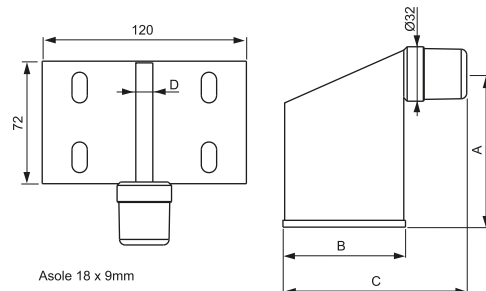

Materiale: Acciaio Zincato

Art.	A	B	C	D	Peso(g)	Conf.
151/1.2	73	50	98	8	580	10
151/2.2	90	70	108	10	820	10

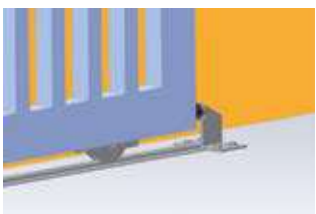



# NOVA-FERR srl

ACCESSORI PER PORTONI A BATTENTE  
ACCESSORIES FOR SWING GATES



Art. 164/S - 166/S    Art. 895/S - 170/S - 165/S    Art. 885/S    Art. 888/S

Cardini superiori



Art. AG20/S

**Agile2.0**



**Link Patented**

Cardini Link tubo quadro

Art. 875/1    Art. 875/2    Art. 875/3



Cardini a fascia

Art. 890/1    Art. 890/2    Art. 890/3



Perni di giunzione per cardini a fascia

Art. 891    Art. 892    Art. 893



Art. 876/1



Art. 876/2



Art. 876/3



Art. 876/4



Art. 876/5

**Pratico Patented**

Cardini Pratico



Art. 886



Art. 887



Art. 163/40



Art. 163/40.4



Art. 143



Art. 144



Art. 145

Cardini

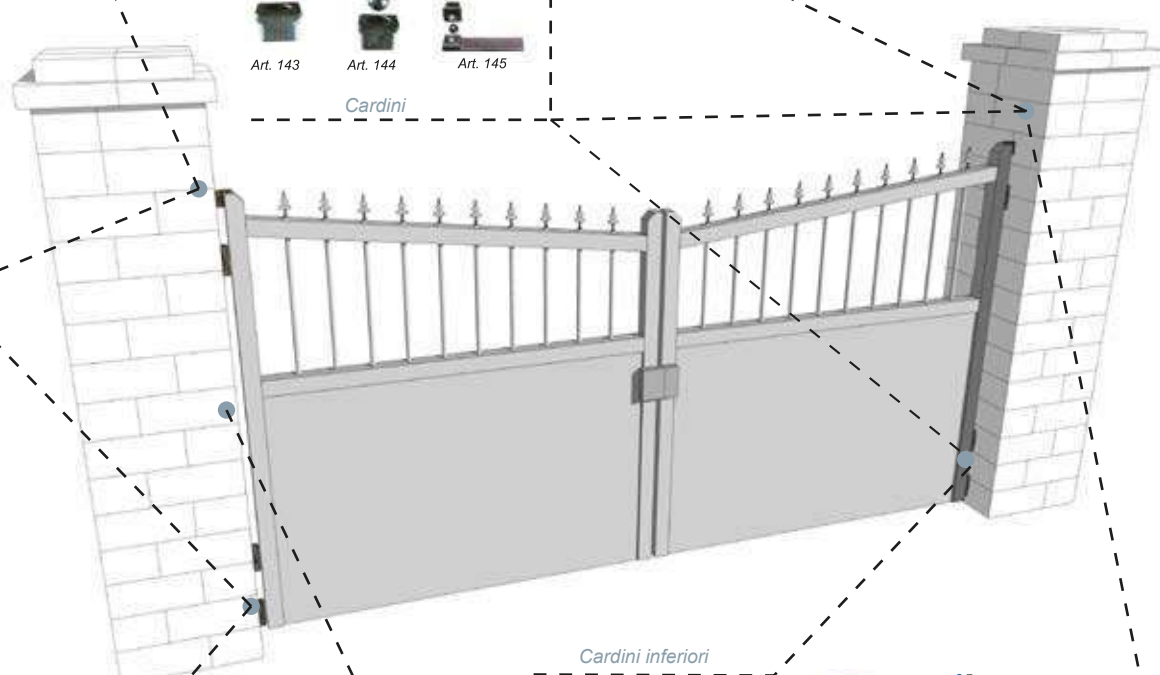

Cardini inferiori



Art. 164/I - 166/I    Art. 895/I - 170/I - 165/I    Art. AG20/I

**Agile2.0**



Dispositivo anti caduta



Art. 253

Perni inferiori

**Pratico Patented**



Art. 827 - 174



Art. 889

Piastre di fissaggio



Art. 159/18



Art. 166P - 164P

Si ricorda che la normativa **EN13241** impone l'utilizzo di un sistema anticaduta

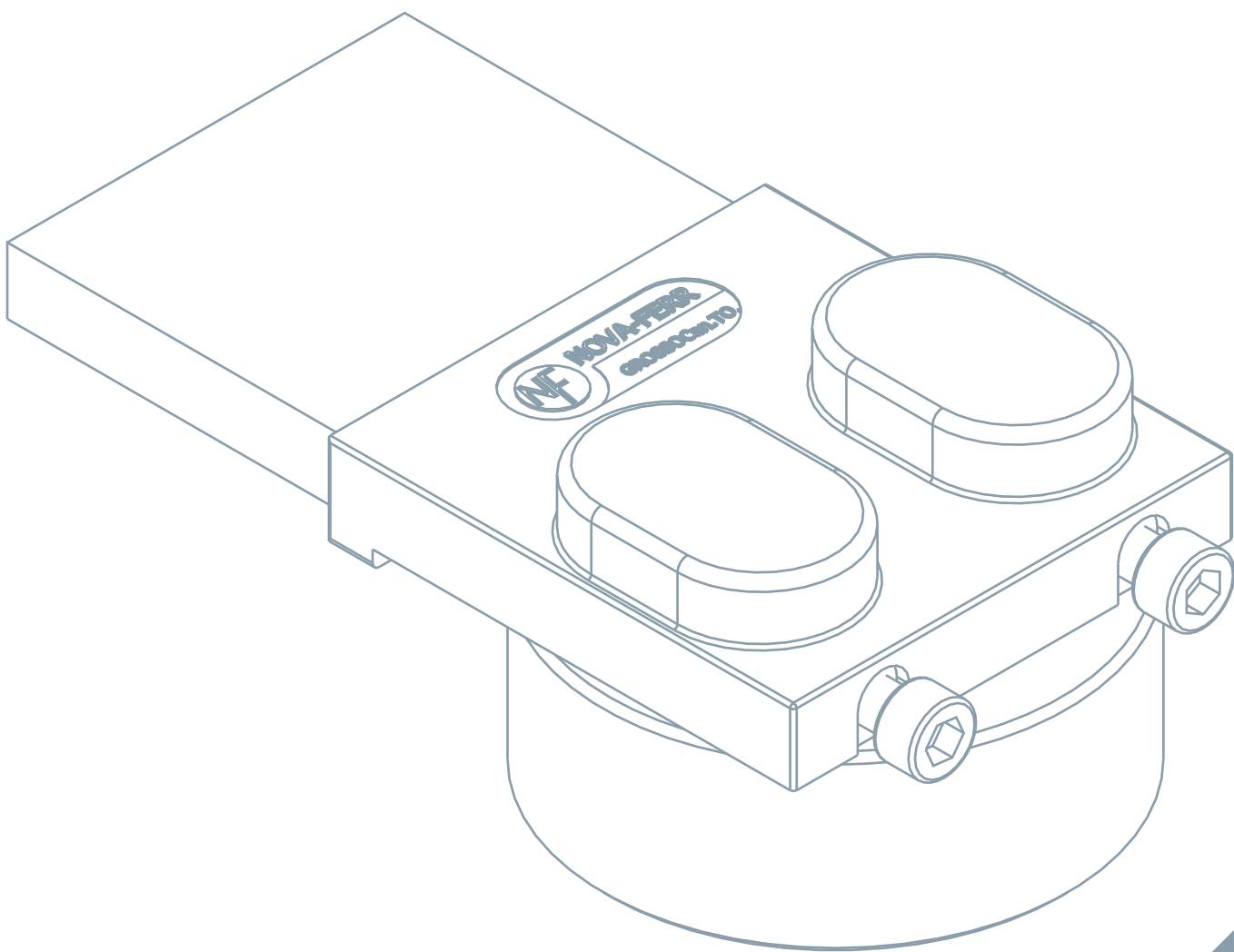

# ACCESSORI PER CANCELLI A BATTENTE

Swing gates accessories - Accessoires portails battants  
Accesorios puertas batientes  
Zubehör für Drehflügel Tore

**CATALOGO  
N.25**

## Art. 895 - 170 - 165 Cardine regolabile con staffa diritta a saldare in acciaio zincato o inox con cuscinetto

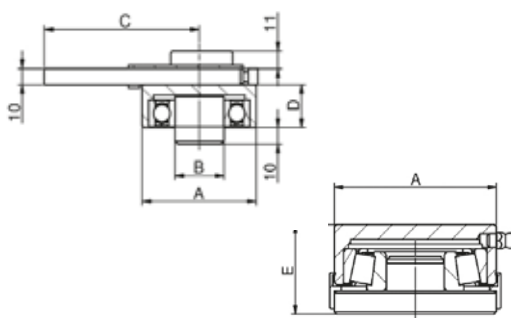

Galvanized or stainless steel adjustable pintle with straight bracket to be welded and thrust bearing

Pivot réglable avec patte droite à souder en acier zingué ou inox avec roulement

Bisagra regulable con placa derecha a soldar en acero cincado o inox con rodamiento

Verstellbares Torband mit Laufroller oder gebogener Platte aus verzinktem Stahl oder Edelstahl mit Kugellager, zum Schweißen.

Materiale: Acciaio Zincato / Acciaio Inox

Art.	A	B	C	D	E	Peso(g)	Portata(Kg)	Conf.
165	50	25	72-84	22	32	1.140	400	2
170	70	30	92-104	26	39	2.200	750	2
895	120	58	130-160	37	51	10.290	1.200	1
1165	50	25	72-84	22	32	1.440	400	2
165/S	50	25	72-84	22		710		2
170/S	70	30	92-104	26		1.250		2
895/S	120	58	130-160	37		6.490		1
1165/S	50	25	72-84	22		710		2
165/I	50				32	430		6
170/I	70				39	950		5
895/I	120				58	3.800		1
1165/I	50				32	430		6

● INOX

● INOX

● INOX

## CARDINE REGOLABILE CON CUSCINETTO

Il brevetto originale NOVAFERR che ha cambiato il mercato

PRODOTTO TOTALMENTE IN ITALIA

Facile da installare | Robusto | Versatile

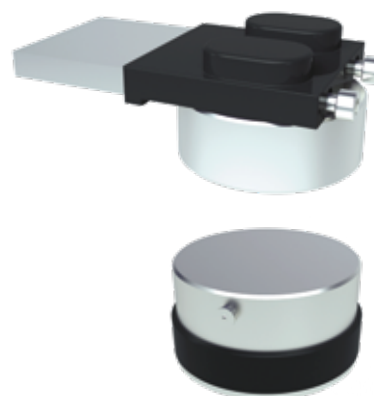

Si ricorda che la normativa **EN13241** impone l'utilizzo di un sistema anticaduta



**Cardine regolabile con staffa piegata in acciaio zincato con cuscinetto**

**Art. 164 - 166**

Galvanized steel adjustable pintle with bended bracket and thrust bearing

Pivot réglable avec patte pliée en acier zingué avec roulement

Gozne regulable con placa plegada en acero cincado con cojinete

Verstellbares Torband mit gebogener Platte aus verzinktem Stahl mit Kugellager

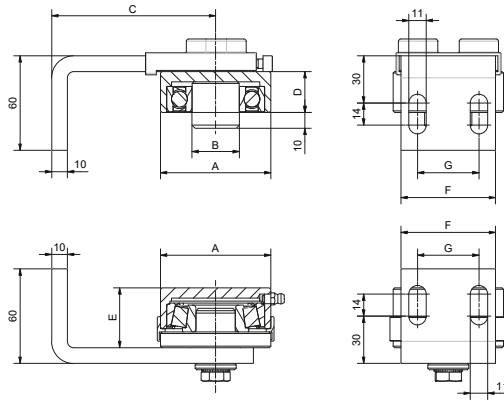

Materiale: Acciaio zincato

Art.	A	B	C	D	E	F	G	Portata(Kg)	Peso(g)	Conf.
<b>164</b>	50	25	81-93	22	32	50	25	400	1.860	2
<b>166</b>	70	30	100-112	26	39	60	39	750	3.320	2
<b>164/S</b>	50	25	81-93	22	32	50	25		1.860	2
<b>166/S</b>	70	30	100-112	26	39	60	39		3.320	2
<b>164/l</b>	50	25	81-93	22	32	50	25		1.860	2
<b>166/l</b>	70	30	100-112	26	39	60	39		3.320	2

**Piastra di fissaggio per Art. 166 e 164**

**Art. 166/P - 164/P**

Fixing plate for Art. 166 and 164

Platine de fixation pour Art. 166 et 164

Placa de fijado para Art. 166 y 164

Befestigungsplatte für Art. 166 und 164

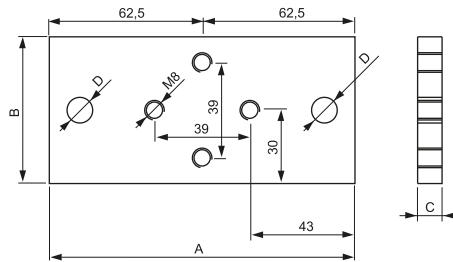

Materiale: Acciaio zincato

Art.	A	B	C	D	Peso(g)	Conf.	Imb.
<b>166/P</b>	125	60	10	10	564	8	32
<b>164/P</b>	125	50	10	10	466	8	32

La piastra di fissaggio è utile come dima per il posizionamento ed il fissaggio del cardine registrabile Art. 166 - 164

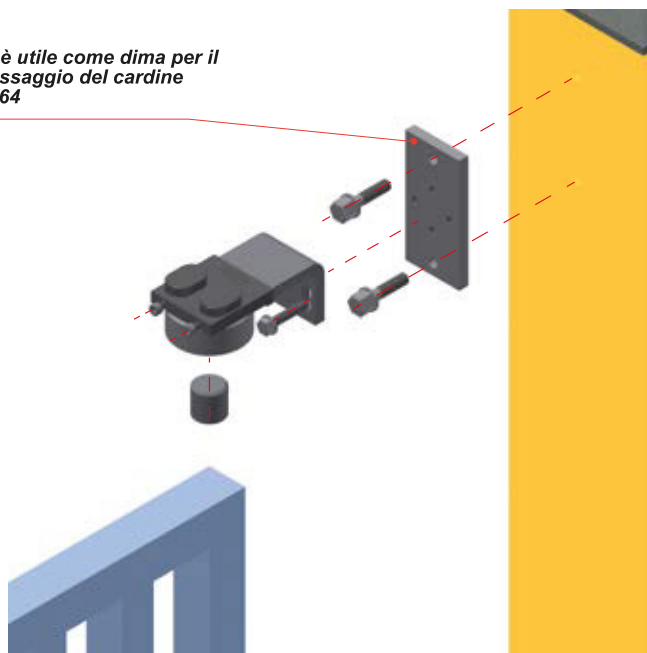

# Agile2.0

## NUOVA VERSIONE

Chiudi / apri cancello meccanico e cardine in un unico prodotto!

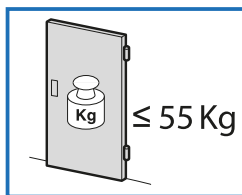
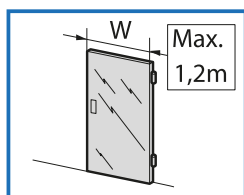

GUARDA IL VIDEO DI AGILE SU  
CANALE YOUTUBE NOVA-FERR

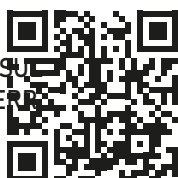

1

DISPONIBILI ACCESSORI  
PER UTILIZZO CON  
CARDINE PRE ESISTENTE

2

MOVIMENTO MECCANICO =  
MINORE MANUTENZIONE

3

REVERSIBILE DX / SX  
E FUNZIONE ARRESTO 90°

**Brevettato**  
**Patented**



COME CARDINE PRINCIPALE







IN AGGIUNTA A CARDINE ESISTENTE  
(IN ASSE CON ALTRO CARDINE)



IN AGGIUNTA A CARDINE ESISTENTE  
(FUORI ASSE CON ALTRO CARDINE)

Cardine a molla Agile nero micaceo completo di piastra

Art. AG20/S

-  Agile spring hinge black micaceous complete with plate
-  Pivot au ressort Agile noir micaceous complète avec plaque
-  Bisagra de muelle ágil negro micáceo completa con placa
-  Glimmerschwarzes Agile-Federscharnier komplett mit Platte

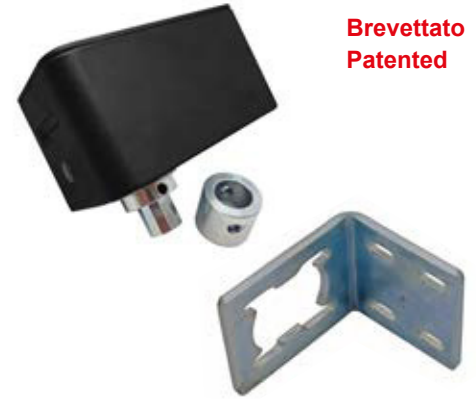
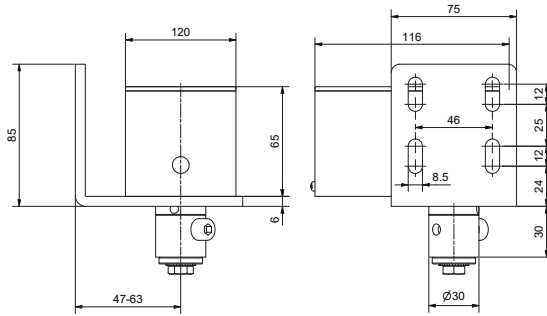

Brevettato  
Patented

Materiale: Acciaio zincato

Art.	Peso(g)	Conf.	Imb.
AG20/S	1527,43	1	6

Cardine a molla Agile ral 9006 completo di piastra

Art. AG20G/S

-  Agile spring hinge ral 9006 complete with plate
-  Pivot au ressort Agile ral 9006 complète avec plaque
-  Bisagra de muelle ágil ral 9006 completa con placa
-  Agiles Federscharnier ral 9006 komplett mit Platte

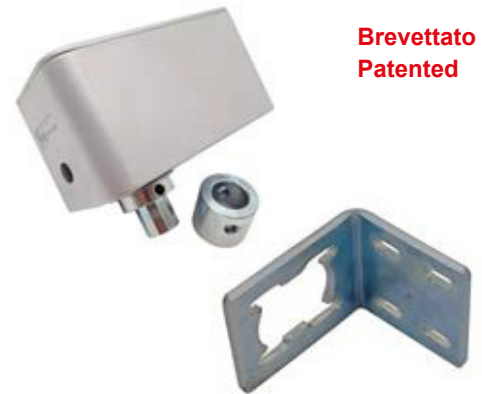
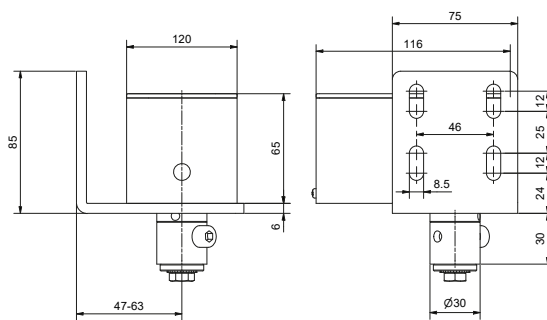

Brevettato  
Patented

Materiale: Acciaio zincato

Art.	Peso(g)	Conf.	Imb.
AG20G/S	1527,43	1	6

Cardine inferiore

Art. AG20/I

-  Lower hinge
-  Pivot inférieure
-  Bisagra inferior
-  Unteres Scharnier

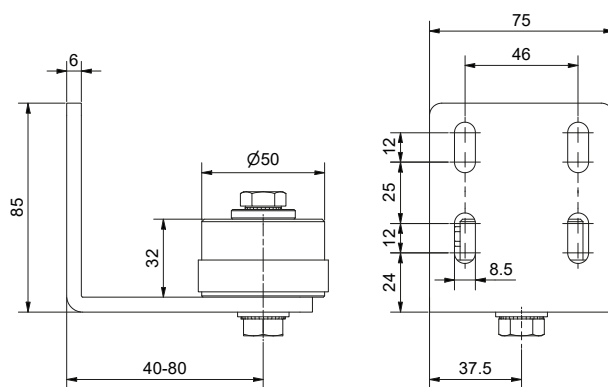

Materiale: Acciaio zincato

Art.	Peso(g)	Conf.	Imb.
AG20/I	1032.4	1	6

## Art. AG21

## Piastra retrofit

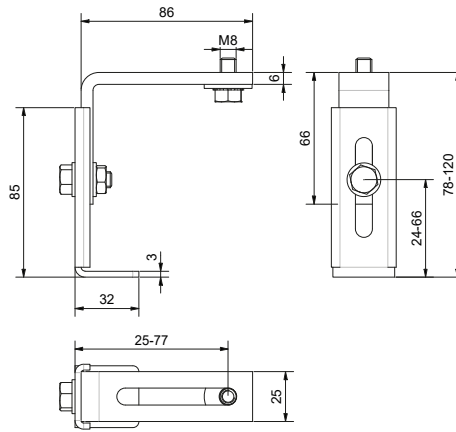

Retrofit plate

Plaque d'adaptation

Placa de retroadaptación

Nachrüstbare Platte

Materiale: Acciaio zincato

Art.	Peso(g)	Conf.	Imb.
AG21	259.27	1	6

## Art. AG22

## Gruppo braccio con guida

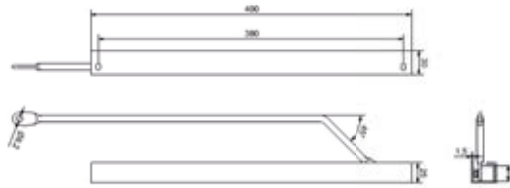

Arm assembly with guide

Ensemble bras avec guide

Conjunto de brazo con guía

Armeinheit mit Führung

Materiale: Acciaio zincato

Art.	Peso(g)	Conf.	Imb.
AG22	626.48	1	6

## Art. AG23

## Gruppo braccio compasso

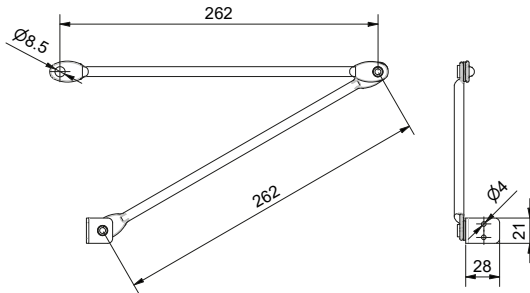

Compass arm assembly

Ensemble bras à compas

Conjunto de brazo brújula

Baugruppe Kompassarm

Materiale: Acciaio zincato

Art.	Peso(g)	Conf.	Imb.
AG23	236.3	1	6

Cardine a molla Agile NERO Micaceo completo di cardine inferiore

Art. AG20

 *Micaceous black Agile spring hinge complete with lower hinge*

 *Pivot à ressort Agile noir micacé complète avec charnière inférieure*

 *Bisagra de muelle Agile negro micáceo completa con bisagra inferior*

 *Glimmerschwarzes Agile-Federscharnier komplett mit unterem Scharnier*

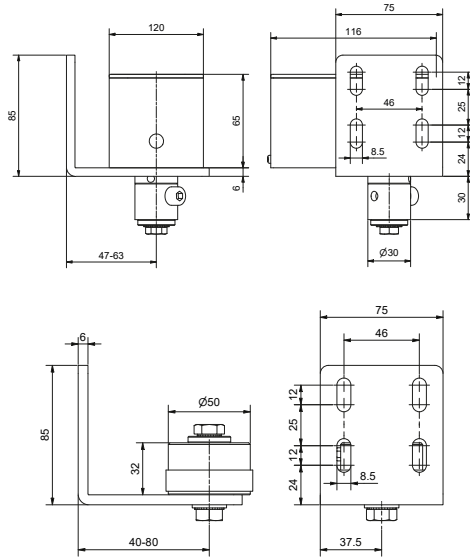

Materiale: Acciaio zincato

Art.	Peso(g)	Conf.	Imb.
AG20	2560	1	6

Cardine a molla Agile RAL 9006 completo di cardine inferiore

Art. AG20G

 *Agile spring hinge RAL 9006 complete with lower hinge*

 *Pivot à ressort Agile RAL 9006 complète avec charnière inférieure*

 *Bisagra de muelle Agile RAL 9006 completa con bisagra inferior*

 *Agile-Federscharnier RAL 9006 komplett mit unterem Scharnier*

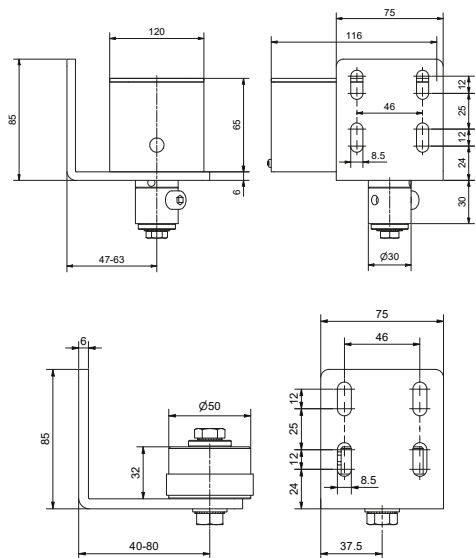

Materiale: Acciaio zincato

Art.	Peso(g)	Conf.	Imb.
AG20G	2560	1	6



Art. 876

Cardine "PRATICO®"

## Pratico

Sistema di registrazione brevettato  
Patented registration system



Link video Pratico

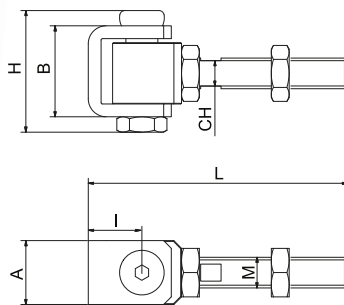

PRATICO® pintle

Gond PRATICO®

Bisagra PRATICO®

PRATICO® Torband

Materiale: Acciaio Zincato

Art.	A	B	H	I	L	M	CH	Peso(g)	Conf.
876/12	25	35	47	21	101	M12	CH10	313	10
876/16	30	40	52	25	106	M16	CH14	363	10
876/18	30	45	57	27	133	M18	CH15	641	10
876/20	30	45	57	27	133	M20	CH17	700	10
876/22	40	52	64	30	137	M22	CH18	924	10
876/24	40	52	64	30	136	M24	CH20	1.054	10

### Composizione, montaggio e registrazione del cardine PRATICO®

## Pratico

**IL CARDINE CON IL SISTEMA DI REGOLAZIONE VELOCE, SEMPLICE E SICURO**  
Facile da installare può essere posato con sistema a saldare, tassellare o murare.

**THE HINGE WITH THE FAST, SIMPLE AND SECURE ADJUSTMENT SYSTEM**  
Easy to install can be welded, dowelled or walled in.

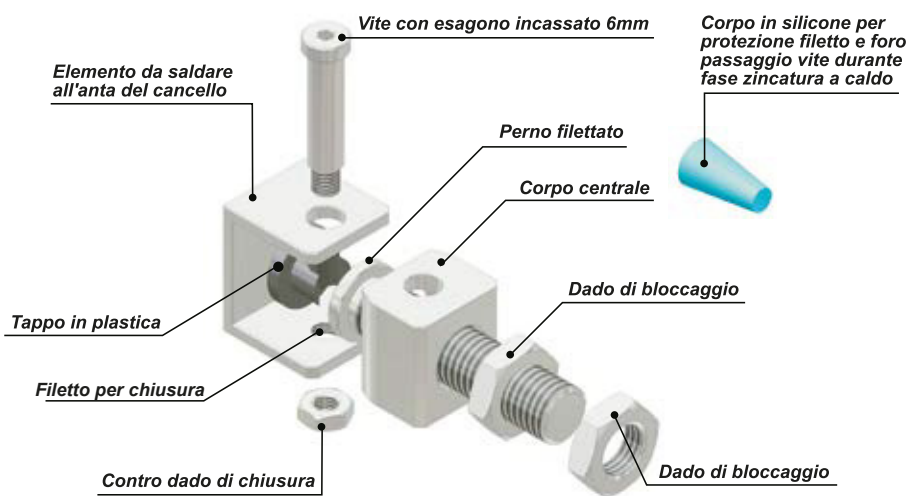

#### Sistema di registrazione

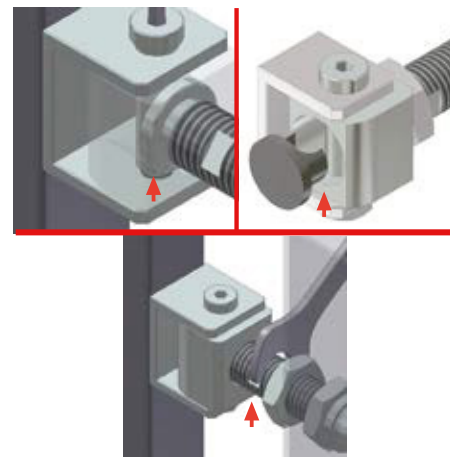

#### Dettaglio registrazione

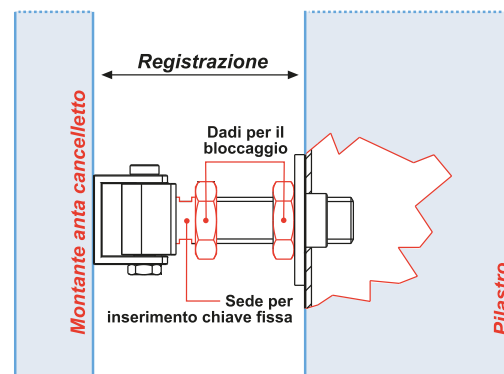

Per i dati sulla registrazione dei cardini far riferimento alle tabelle di ogni singolo cardine

Saldare elemento in ferro ed il cardine all'anta del cancello

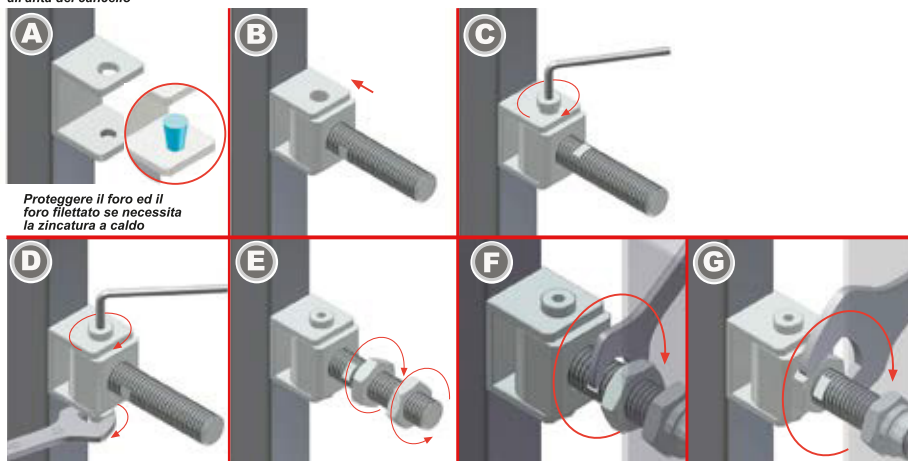

Cardine "LINK"

Art. 875

-  LINK pintle
-  Gond LINK
-  Bisagra LINK
-  LINK Torband

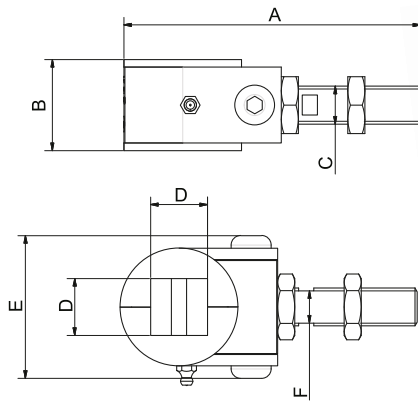

**Link**

Sistema di registrazione brevettato

Materiale: Acciaio Zincato

Art.	A	B	C	D	E	F	Peso(g)	Conf.
875/30	156	48	M20	30	75	CH17	121	2
875/40	171	48	M22	40	90	CH18	150	2
875/50	181	48	M24	50	100	CH20	170	2

Composizione, montaggio e registrazione del cardine LINK

**SISTEMA DI REGOLAZIONE VELOCE, SEMPLICE E SICURO**

Facile da installare può essere posato con sistema a saldare, tassellare o murare.

**FAST, SIMPLE AND SECURE ADJUSTMENT SYSTEM**

Easy to install can be welded, dowelled or walled in.

**Link**

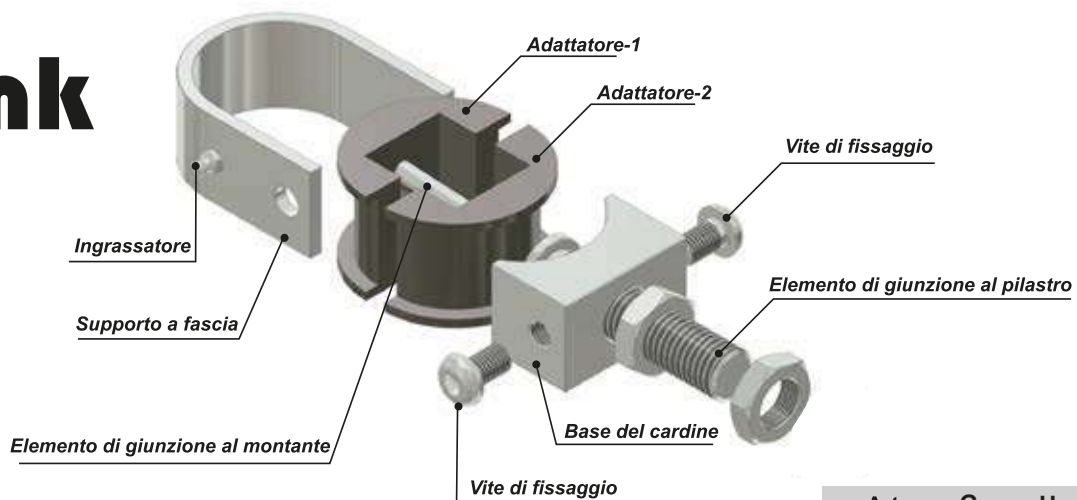

Art.	G	H	I	L
875/30	24	70 - 100	CH30	CH15
875/40	24	70 - 100	CH32	CH17
875/50	24	70 - 100	CH36	CH19

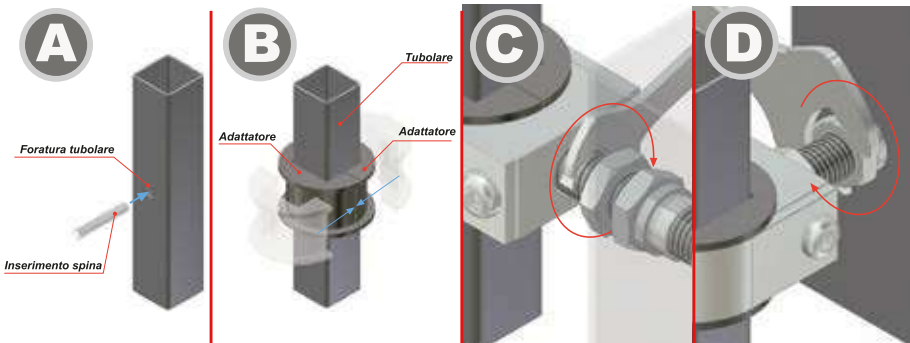

**Dimensione del foro**

- Tubolare 30mm: foro Ø 8.5mm
- Tubolare 40mm: foro Ø 8.5mm
- Tubolare 50mm: foro Ø 8.5mm

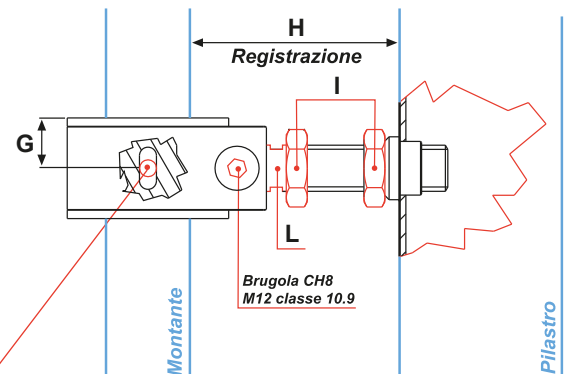

## Art. 920

## Boccola per cardini PRATICO e LINK



**Pratico**  
**Link**

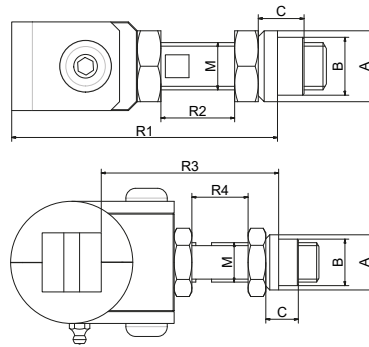

Bushing for PRATICO® and LINK

Douille pour PRATICO® and LINK

Buche para PRATICO® and LINK

Buchse für PRATICO® and LINK

Materiale: Acciaio zincato

Art.	A	B	C	M	R1	R2	R3	R4	Peso(g)	Conf
920.12	Ø20	Ø15	15.5	M12	66-93	8-35			19	10
920.16	Ø24	Ø19	15.5	M16	74-97	9-32			25	10
920.18	Ø26	Ø21	15.5	M18	79-124	9-54			30	10
920.20	Ø28	Ø23	16.5	M20	79-124	9-54	70-100	10-38	35	10
920.22	Ø30	Ø25	17.5	M22	84-126	9-51	70-100	9-40	40	10
920.24	Ø36	Ø29	25	M24	88-124	9-43	70-100	10-40	90	10

## Art. 921

## Piastra a saldare per cardini PRATICO e LINK



**Pratico**  
**Link**

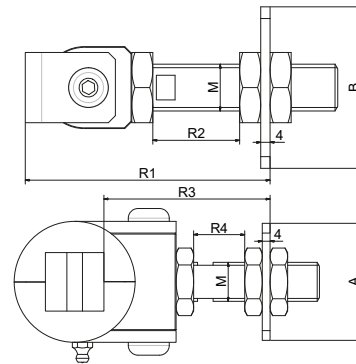

Plate to be welded for PRATICO® and LINK

Platine à souder pour PRATICO® and LINK

Soporte para soldar para PRATICO® and LINK

Platte zum Schweißen für PRATICO® and LINK

Materiale: Acciaio zincato

Art.	A	B	M	R1	R2	R3	R4	Peso(g)	Conf
921.12	60	50	M12	63-94	8-40			100	10
921.16	60	50	M16	72-98	9-36			110	10
921.18	60	50	M18	77-124	9-57			115	10
921.20	60	70	M20	77-124	9-57	70-100	10-40	155	10
921.22	60	70	M22	81-127	9-54	70-100	9-43	160	10
921.24	60	70	M24	82-126	9-54	70-100	10-48	173	10

## Art. 922

## Piastra a tassellare per cardini PRATICO e LINK



**Pratico**  
**Link**

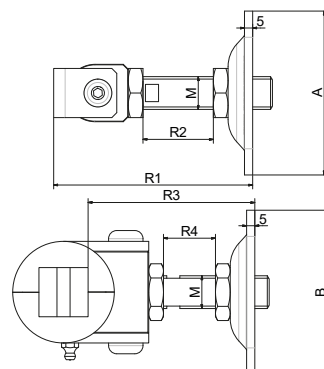

Plate to be doweled for PRATICO® and LINK

Platine à visser pour PRATICO® and LINK

Soporte para atornillar para PRATICO® and LINK





Platte zum Dübeln für PRATICO® and LINK

Materiale: Acciaio zincato

Art.	A	B	M	R1	R2	R3	R4	Peso(g)	Conf
922.12	100	100	M12	70-100	8-35			378	10
922.16	100	100	M16	80-105	9-32			385	10
922.18	100	100	M18	85-130	9-55			390	10
922.20	100	100	M20	85-130	9-55	70-100	10-40	395	10
922.22	100	100	M22	85-130	9-50	70-100	9-40	400	10
922.24	100	100	M24	85-130	9-50	70-100	10-45	415	10

**Tube a murare per cardini PRATICO e LINK**

**Art. 923**

-  Tube for walling for PRATICO® and LINK
-  Tubofix à sceller pour PRATICO® and LINK
-  Tubofix de encarcerar para PRATICO® and LINK
-  Stift zum Zementieren für PRATICO® and LINK

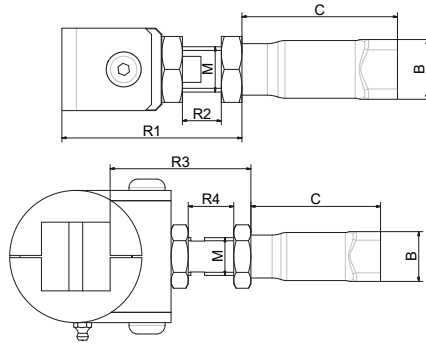

**Pratico Link**







Materiale: Acciaio zincato

Art.	A	B	M	R1	R2	R3	R4	Peso(g)	Conf
923.18	26	65	M18	73-122	9-59			70	10
923.22	30	75	M22	77-127	9-59	70-100	9-40	120	10

**Piastrina apertura 180° per cardine PRATICO**

**Art. 924**

-  Plate for 180° opening for PRATICO®
-  Platine ouverture 180° pour PRATICO®
-  Placa regulable de apertura a 180° para PRATICO®
-  Platte für 180° Öffnung für PRATICO®

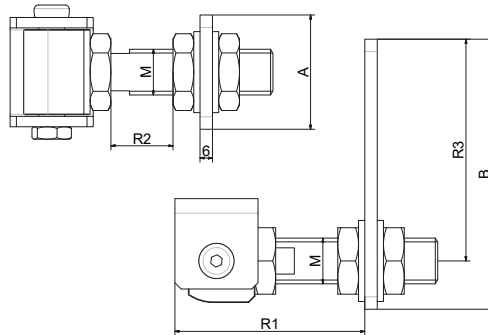

**Pratico**



Materiale: Acciaio Zincato

Art.	A	B	M	R1	R2	R3	Peso(g)	Conf
924.12	55	75	M12	53-77	8-33	41-56	180	10
924.16	55	90	M16	70-79	9-28	54-69	210	10
924.18	55	100	M18	64-97	9-43	58-78	230	10
924.20	55	120	M20	64-79	9-43	72-97	270	10
924.22	55	130	M22	70-102	9-40	81-106	280	10
924.24	55	140	M24	72-100	9-38	90-115	310	10

**Tabella accoppiamento cardine LINK**

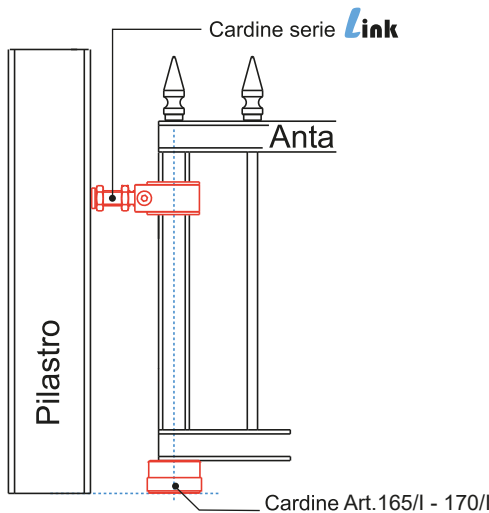

**Link**



 Art. 165/I

Art.  
875/30  
875/40

 Art. 170/I

875/50

Art. 827 - 174

Perno e piastra inferiori per cardini "PRATICO"



**Pratico**

Materiale: Acciaio zincato

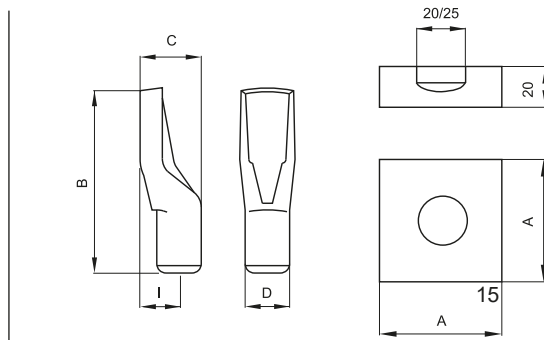

- Bottom pin and plate for pintles PRATICO®
- Pivot et platine inférieure pour gonds PRATICO®
- Perno y placa inferior para bisagra PRATICO®
- Bodenplatte mit Zapfen für PRATICO® Torband

Art.	A	B	C	D	I	Peso(g)	Conf.	
827/18	60	97	37	20	27	620	15	
827/22	70	106	41,5	23	30	1.040	15	
174/18	60	87	30	20	20	620	15	
174/22	70	98	35	23	23,5	1.040	15	
174/18.1		87	30	20	20	solo perno	230	15
174/22.1		98	35	23	23,5	solo perno	330	15
174/18.2	60					solo piastra	380	15
174/22.2	70					solo piastra	720	15



## Tabella accoppiamento cardini "PRATICO"

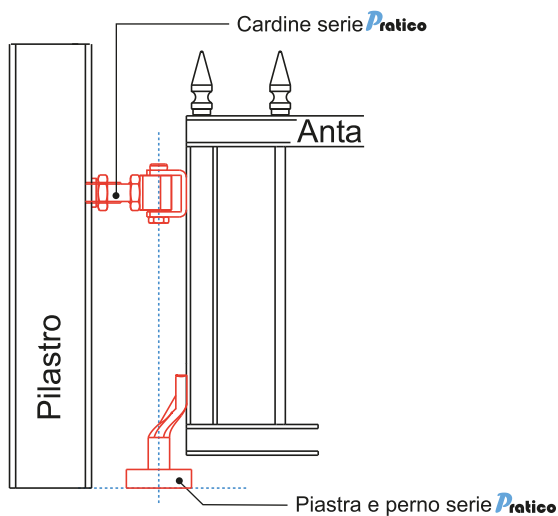

**Pratico**



Art. 827/18

Art.
876/18
876/20



Art. 827/22

876/22
876/24

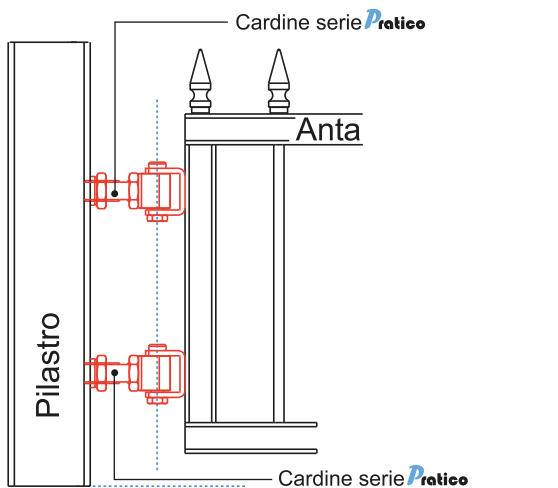

**Pratico**



Art. 876/12

Art.
2x 876/12



Art. 876/16

2x 876/16
-----------

Art. 890

Cardine a fascia registrabile

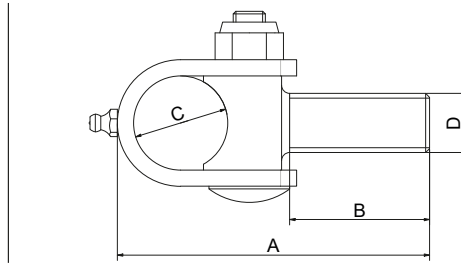

Adjustable band hinge

Pivot à bande réglable

Bisagra de banda ajustable

Einstellbares Bandscharnier

Materiale: Acciaio zincato

Art.	A	B	C	D	Peso(g)	Conf.
890/18	103	46	Ø 30	M18	470	10
890/22	116	52	Ø 35	M22	710	10
890/24	132	59	Ø 40	M24	1.050	10



Art. 159

Piastra di registrazione a tassellare per cardini a fascia

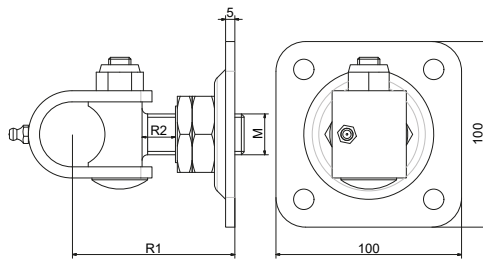
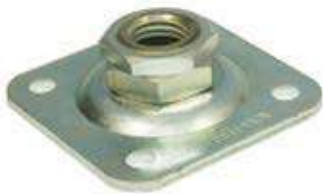

Adjustable dowel plate for band hinges

Plaque de gousset réglable pour pivot à bande

Placa de registro de fijacion a pared para bisagras de banda

Knotenblech für Bandscharniere

Materiale: Acciaio zincato

Art.	M	R1	R2	Peso(g)	Conf
159.18	M18	70-77	5-12	540	10
159.22	M22	74-87	5-18	550	10
159.24	M24	80-101	5-26	540	10



Art. 891 - 892

Tronchetto di giunzione a saldare per cardini a fascia



Art.891

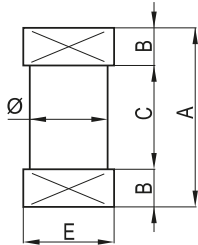

Art.892

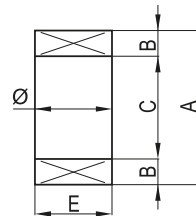

Connection pin for clamp hinge to be welded

Pivot d'articulation pour gond à bride à souder

Eje a soldar para bisagra abrazadera

Anschweißstück für Halseisenband zum Schweißen

Materiale: Acciaio grezzo

Art.	A	B	C	Ø	E	Peso(g)	Conf.
891/1	57	10	37	30	35	495	12
891/2	62	10	42	35	40	780	12
891/3	62	10	42	40	50	1.085	12
892/1	57	10	37	30	30	355	12
892/2	62	10	42	35	35	555	12
892/3	62	10	42	40	40	872	12



Art. 893

Perno di giunzione ad inserimento per cardini a fascia

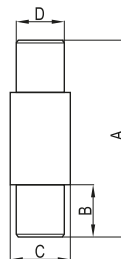

Connection pin to be inserted for clamp hinges

Pivot d'articulation à insérer pour gonds à bride

Eje de unión a insertar para bisagras de banda

Anschweißstück mit Rund fuß für Halseisenband zum Einfügung

Materiale: Acciaio Grezzo

Art.	A	B	C	D	Peso(g)	Conf.
893/1	110	30	Ø30	Ø24	480	12
893/2	115	30	Ø35	Ø29	710	12
893/3	130	30	Ø40	Ø34	1.121	12



## Art. 885

## Cardine completo con regolazione

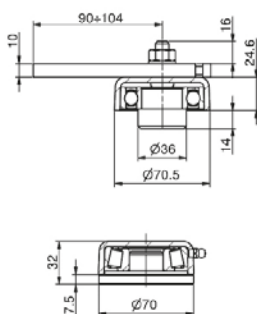

Materiale: Acciaio zincato

🇬🇧 Complete pintle with adjustment

🇫🇷 Pivot complete avec réglage

🇪🇸 Bisagra completa, regulable

🇩🇪 Oberes und unteres Verstellbares Torband

Art.	Peso(g)	Conf.
885	2.040	6
885/S	1.210	8
885/I	830	16

## Art. 888

## Cardine regolabile "Pivotto®" a saldare

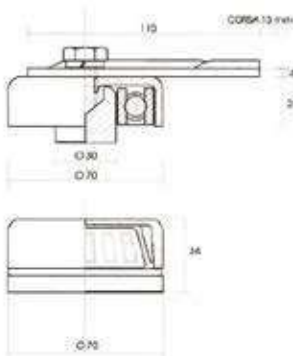

Materiale: Acciaio Zincato

🇬🇧 Adjustable pintle "Pivotto®" to be welded

🇫🇷 Pivot réglable "Pivotto®" à souder

🇪🇸 Bisagra regulable "Pivotto®" a soldar

🇩🇪 Verstellbares Torband Pivotto® zum Schweißen

Art.	Peso(g)	Conf.
888	1.580	6
888/S	770	8
888/I	810	16

## Art. 164/A - 166/A

## Cardine con cuscinetto per scatolati in alluminio

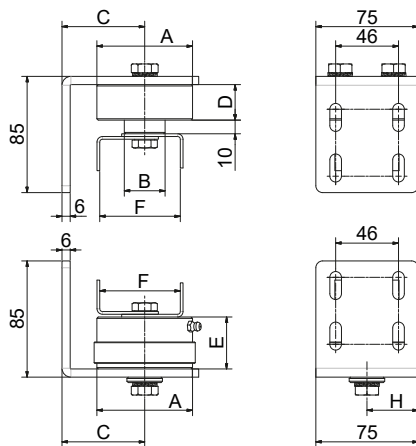

Materiale: Acciaio Zincato

🇬🇧 Pintle with thrust bearing for aluminium profiles

🇫🇷 Pivot avec roulement pour profilés en aluminium

🇪🇸 Bisagra con rodamiento para perfiles de aluminio

🇩🇪 Torband mit Langerreibung für Aluminiumtore

Art.	A	B	C	D	E	F	Peso(g)	Conf.
164/A	50	25	40-80	22	32	40-50	1630	2
166/A	70	30	40-80	26	39	60-70	2560.6	2

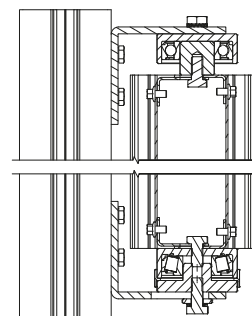

Cardine per cancelletti

Art. 926

-  Pintle for gates
-  Pivot pour portillons
-  Bisagra para puertas
-  Torband für Tore

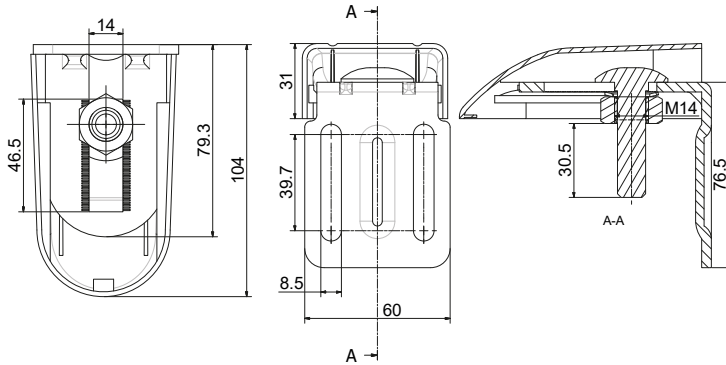





Materiale: Acciaio zincato

Art.	Peso(g)	Conf.
926	620.39	2

Perno inferiore a saldare per piastra base

Art. 894

-  Bottom pin to be welded for bottom plate
-  Pivot à souder pour platine inférieure
-  Perno inferior a soldar para placa base
-  Untere Bodenplatte mit Bolzen, zum Schweißen

Art. 894/1 - 2

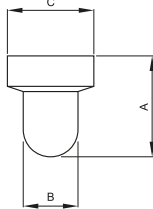

Art. 894/3 - 4

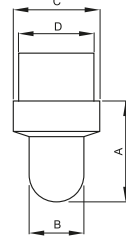

Art. 894/1 - 2



Art. 894/3 - 4







Materiale: Acciaio Grezzo

Art.	A	B	C	D	Abbinam.	Peso(g)	Conf.
894/1	35	Ø20	Ø30		174/18.2	100	12
894/2	35	Ø23	Ø35		174/22.2	140	12
894/3	35	Ø20	Ø30	Ø24	174/18.2	160	12
894/4	35	Ø23	Ø35	Ø29	174/22.2	220	12



Cardine con perno per cancelli in ferro, tubolare 40 e 50, parte superiore e inferiore

Art. 143 - 144

-  Pintle with pin for tubular iron gates 40 and 50, up component
-  Gond avec pivot pour portails en fer tubulaire 40 et 50, partie supérieure
-  Bisagra con perno para cancelles en hierro tubular 40 y 50, parte superior
-  Oberes und unteres Torband mit Drehstift für Tore mit Eisenstangen Ø 40 oder 50 mm

Art. 143

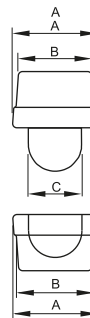

Art. 144

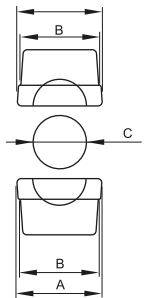

Materiale: Acciaio grezzo

Art.	A	B	C	Peso(g)	Conf.
143/40	40	33	26	570	12
143/50	50	43	26	820	12
144/40	40	33	26	700	12
144/50	50	43	29	1080	12



## Art. 145

## Coppia di cardini per cancelli in ferro tubolare 40 e 50

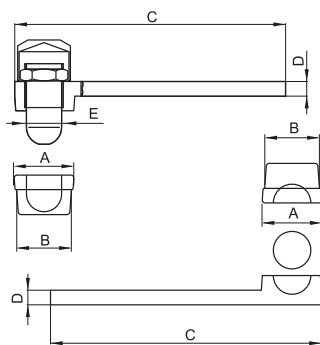

Couple of pintles for tubular iron gates 40 and 50

Couple de gonds avec bille pour portails en fer tubolaire 40 et 50

Dos bisagras con esfera para cancelas en hierro tubular 40 y 50

Paar von Torbänder für Tore mit Eisenstangen aus Ø 40 oder 50 mm

Materiale: Acciaio Grezzo

Art.	A	B	C	D	E	Peso(g)	Conf.
145/40	40	33	185	10	25	2.100	2
145/40S	40	33	185	10	25	1.100	4
145/40I	40	33	185	10	25	1.000	4
145/50	50	43	190	10	30	2.930	2
145/50S	50	43	190	10	30	1.530	4
145/50I	50	43	190	10	30	1.450	4

## Art. 163/40.4 - 163/40

## Cardine su cuscinetto - Cardine su sfera



Art. 163/40.4 su cuscinetto

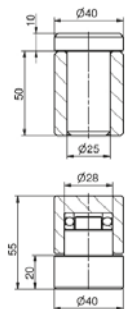

Art. 163/40 su sfera

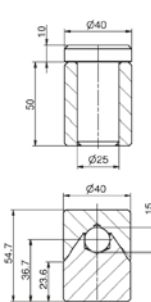

Pintle on ball bearing  
Pintle on ball

Pivot sur roulement  
Pivot sur bille

Punto de giro con rodamiento  
Punto de giro con esfera

Torband auf Sphäre.  
Torband auf Kugellager

Materiale: Acciaio Zincato

Art.	Peso(g)	Conf.
163/40.4	1.070	6
163/40	1.090	6

## Art. 886

## Cardine snodato registrabile piccolo/grande

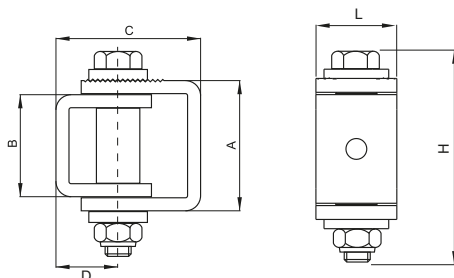

Adjustable jointed hinge, small and large

Pivot articulée réglable, petite et grande

Bisagra pequeña y grande articulada, con registraci3n horizontal, de acero y con rodamiento a bola.

Kleines oder großes Gelenktorband mit U-Bügel, einstellbar.

Materiale: Acciaio Zincato

Art.	A	B	C	D	H	L	Portata (Kg)	Peso(g)	Conf.
886/1	45	30	59,79 - 62	28,5	77	30	150	410	10
886/2	60	45	62-68	27	87	35	200	540	10

**Piastra inferiore con perno per cardini**

**Art. 889**

Bottom plate with pin for pintles

Platine inférieure avec pivot pour gonds

Placa inferior con perno para bisagra

Untere Platte mit Drehstift für Torband

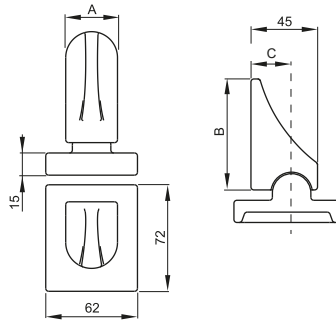

Materiale: Acciaio grezzo

Art.	A	B	C	Peso(g)	Conf.
889.1	35	75	28,5	880	10
889.2	45	85	22,5	1.030	10

**Cardine regolabile a cavallotto**

**Art. 887**

Adjustable stampl pintle

Pivot réglable avec cavalier

Bisagra regulable con caballete

Einstellbares Torband mit U-Bügel

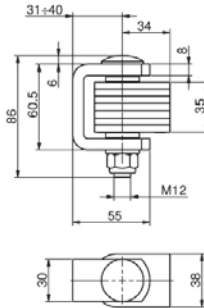

Materiale: Acciaio zincato

Art.	Peso(g)	Conf.
887	658	16

**Arresto per cancelli a battente in acciaio zincato, ad avvitare**

**Art. 250**

Galvanized stop for wings gates, to be screwed

Butée zinguée pour grilles à battant, à visser

Tope para puerta batiente en acero cincado, a atornillar

Bodenaufschuh aus Verzinktem Stahl für Flügel Tore. Zum Anschrauben

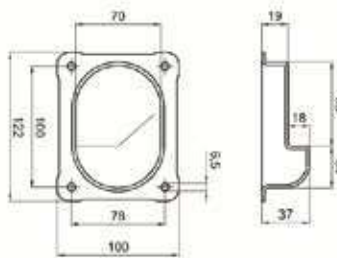

Materiale: Acciaio zincato

Art.	Peso(g)	Conf.
250	270	6

**Arresto in acciaio zincato per cancelli a battente, a cementare**

**Art. 146**

Galvanized stop for wings gates

Butée zinguée pour grilles à battant

Tope para puerta batiente en acero cincado

Bodenaufschuh aus Verzinktem Stahl für Flügel Tore.

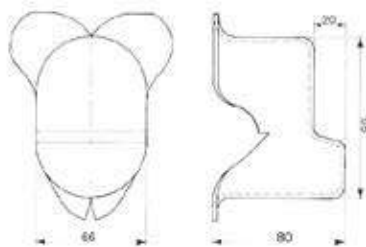

Materiale: Acciaio Zincato

Art.	Peso(g)	Conf.
146	410	10

## Art. 255

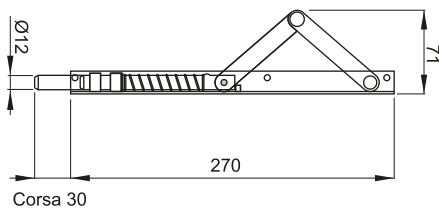

Materiale: Acciaio Inox

Art.	Peso(g)	Conf.
255	400	12

## Paletto a molla in acciaio INOX

- Stainless steel spring bolt
- Verrou en acier inox à ressort
- Pestillo en acero inox con resorte
- Edelstahl-Türkantriegel mit Feder



## Art. 265

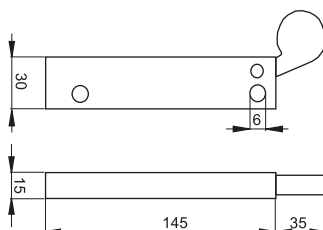

Materiale: Acciaio Inox

Art.	Peso(g)	Conf.
265	380	6

## Paletto a molla in acciaio inox ambidestro

- Ambidextrous stainless steel spring bolt
- Verrou ambidextre à ressort en acier inox
- Pestillo en acero inox con muelle ambidiestro
- Beidhändiger Edelstahl-Türkantriegel mit Feder



## Art. 184

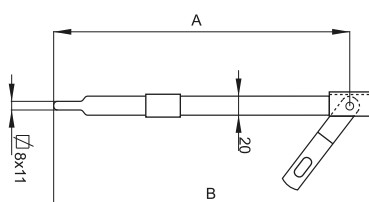

Materiale: Acciaio Zincato

Art.	A	B	Peso(g)	Conf.
184/50	485	455	620	10
184/70	680	650	860	10

## Paletto pesante a saldare

- Heavy bolt to be welded
- Verrou lourd à souder
- Pestillo pesante a soldar
- Massiver Türkantriegel zum Anschrauben



## Art. 183

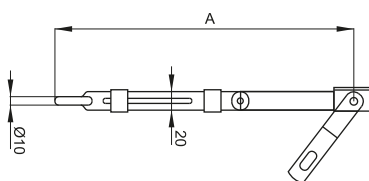

Materiale: Acciaio Zincato

Art.	A	Peso(g)	Conf.
183/35	350	300	10
183/45	450	350	10
183/60	600	450	10
183/70	700	500	10

## Paletto leggero a saldare

- Light bolt to be welded
- Verrou léger à souder
- Pestillo ligero a soldar
- Leichter Türkantriegel zum Anschrauben



Dispositivo di sicurezza anticaduta

Art. 253

🇬🇧 Anti-fall safety device

🇫🇷 Dispositif de sûreté anti-chute

🇪🇸 Dispositivo de seguridad anti-caída para portones

🇩🇪 Stützeinrichtung

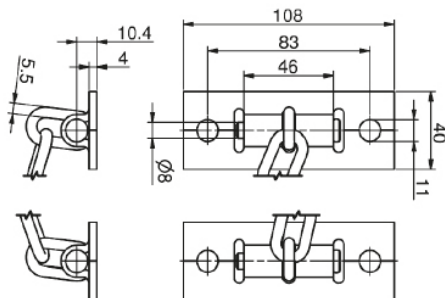

Materiale: Acciaio zincato

Art.	Peso(g)	Conf.
253	430	8

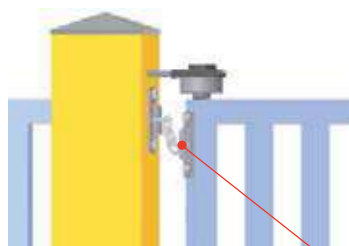

Dispositivo REGOLABILE a seconda della distanza tra piantone ed anta.  
Per una corretta applicazione è necessario che la catena di congiunzione sia in tensione.  
**Si consiglia l'applicazione su parte superiore e su parte inferiore (Come in foto)**

Device ADJUSTABLE according to the distance between the pillar and the leaf  
For correct application the connecting chain must be under tension.  
**It is recommended to apply on top and bottom part (as in the picture).**

**Il dispositivo anticaduta Art. 253 è indispensabile come strumento di sicurezza contro eventuali incidenti.**

**The anti-fall safety device Art. 253 it's essential as a safety tool against potential incidents.**

**Si ricorda che la normativa EN13241 impone l'utilizzo di un sistema anticaduta**  
**Please note that the EN13241 standard requires the use of a fall arrest system**

**IMPORTANTE! - ATTENTION!**

Facciamo presente che a catalogo è possibile trovare anche la serie completa di **Cerniere per cancelli a battente**.  
Questi articoli sono compresi tra i prodotti della sezione **"CERNIERE PER USI VARI"** si trovano da pag.124 a pag.129 del presente catalogo e sono gli articoli compresi tra l'Art.136 fino e l'Art.193.

Please note that the catalogue also includes the complete series of **Hinges for swing gates**.  
These articles are included in the products in the **"HINGES FOR VARIOUS USES"** section on pages 124 to 129 of this catalogue and are the articles included between Art. 136 up to Art. 193.

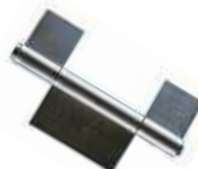

# NOVA-FERR srl

ACCESSORI PER CANCELLI AUTOPORTANTI  
ACCESSORIES FOR SELF STANDING GATES



## CANTILEVER Gate System



**Basic Kit**  
450Kg - L= 4000

**Medium Kit**  
600Kg - L= 10000

**Magnum Kit**  
1200Kg - L= 15000

**Aluminium Kit**  
400Kg - L= 8000



Art. 162



Art. 153/4 - 153/5

Rulli e Supporti



Art. 854

Incontro



Art. 852



Art. 852/4

Ruote terminali

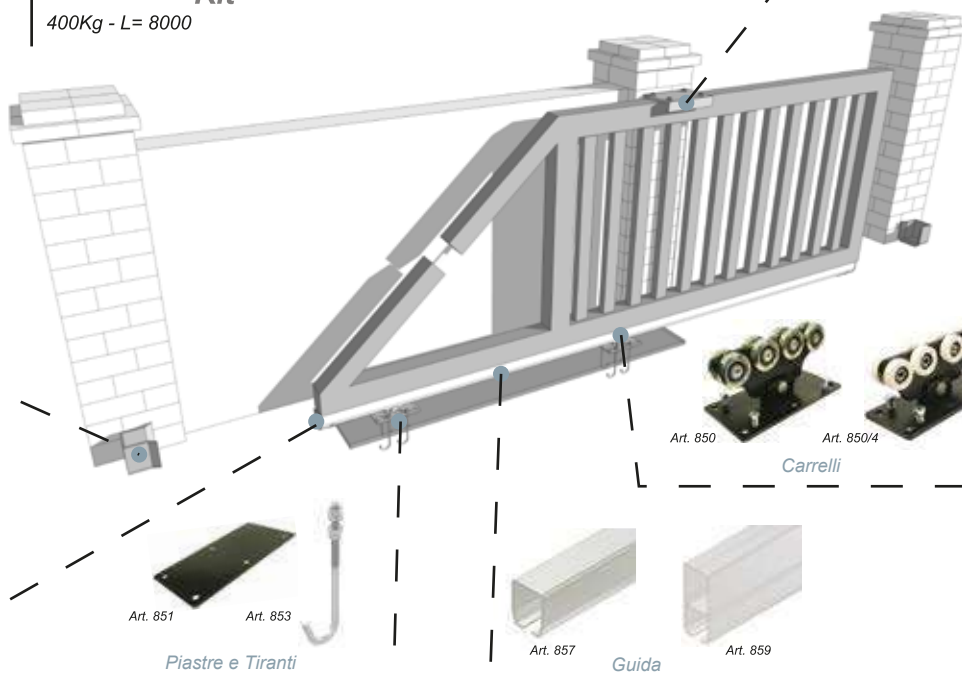

Art. 851

Art. 853

Piastre e Tiranti



Art. 850



Art. 850/4

Carrelli



Art. 857

Guida



Art. 859

## Sistema **Ulisse** Senza guida a terra

Max L= 4500 / 300Kg



Art. 3090

Guida



Art. 854

Incontro

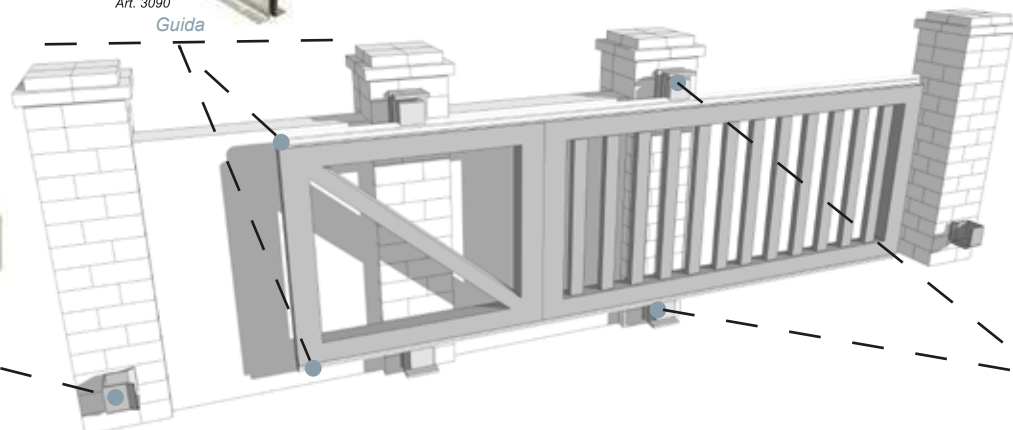

Art. 856/2



Art. 856/1

Carrelli per cancello  
autoportante

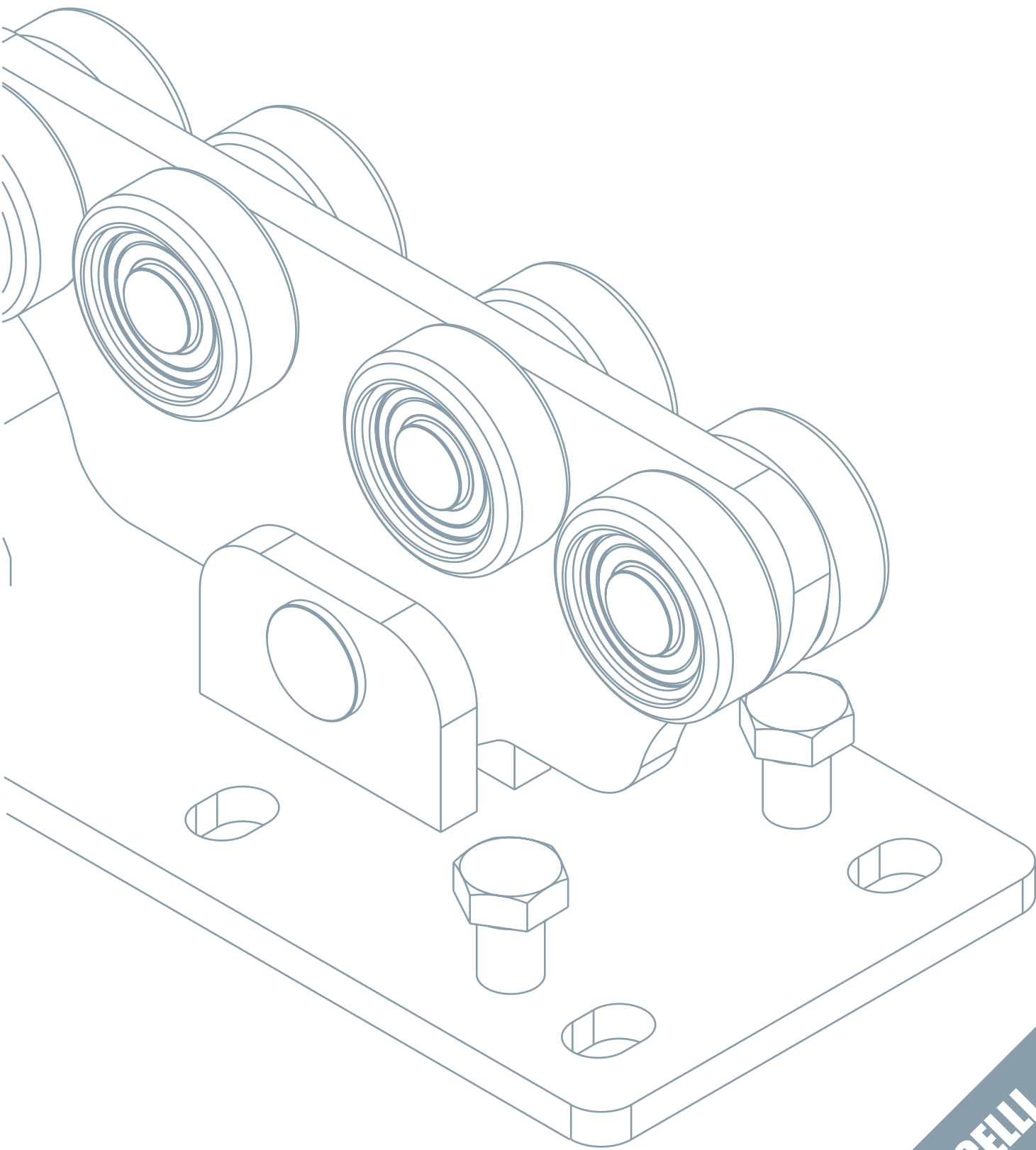

# ACCESSORI PER CANCELLI AUTOPORTANTI

Self-supporting gates accessories  
Accessoires portails autoportants  
Accesorios puertas autoportantes  
Zubehör für freitragende Tore

**CATALOGO  
N.25**

## Applicazione accessori Sistema CANTILEVER

**CANTILEVER**  
Gate System

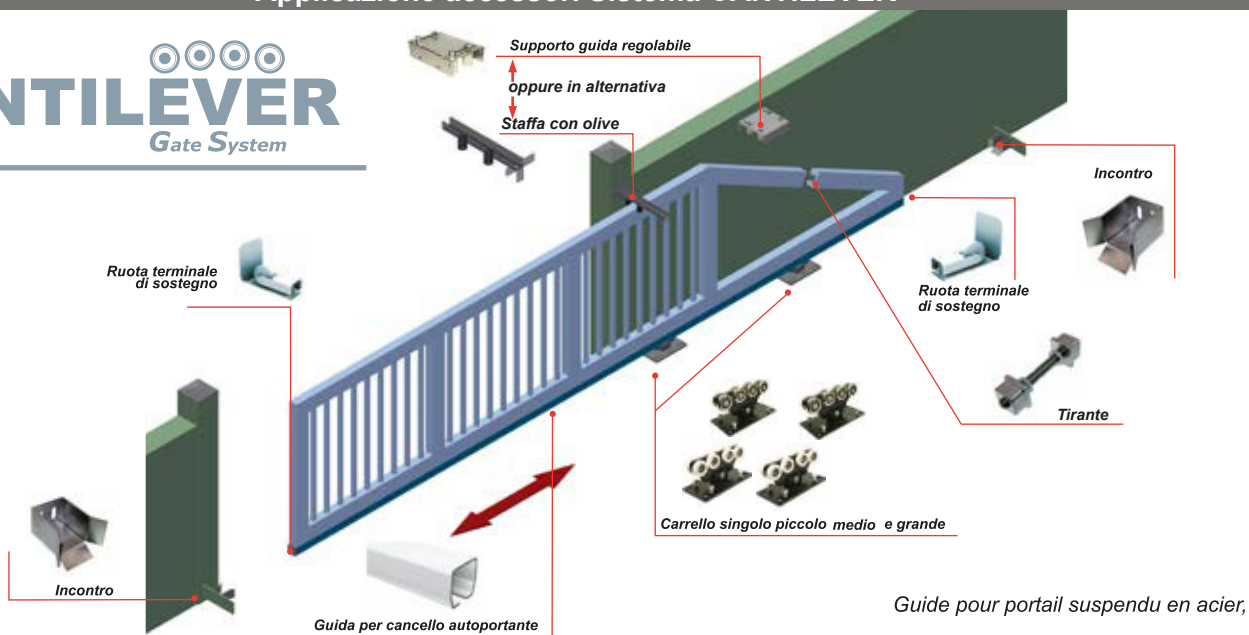

Guide pour portail suspendu en acier,

### Art. 857 Guida per cancello autoportante in acciaio zincato ad alto limite di snervamento

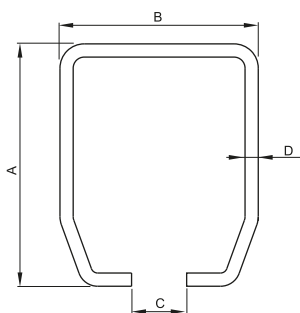

Materiale: Acciaio micro-legato ad alto limite di snervamento per formatura a freddo in base a DIN EN 10346 / DIN EN 10143

🇬🇧 Steel guide for cantilever gate made with high yield strength micro-alloyed steel for cold forming according to DIN EN 10346 / DIN EN 10143

🇫🇷 Guide pour portail suspendu en acier micro-allié à haute limite d'élasticité pour formage à froid selon DIN EN 10346 / DIN EN 10143

🇪🇸 Guía para portones suspendidos en acero de aleación de alto límite elástico para formación en frío según DIN EN 10346 / DIN EN 10143

🇩🇪 Führungsschiene für Selbsttragende Tore Mikrolegierter Stahl mit hoher Streckgrenze für Kaltumformung nach DIN EN 10346 / DIN EN 10143

Art.	A	B	C	D	Lunghezza	Finitura	Peso(g/mt)	Conf.	Imb.
857/1.3.76	60	65	18	3,5	3mt.	zincato	5.520	1	30
857/1.6.76	60	65	18	3,5	6mt.	zincato	5.520	1	30
857/2.3.76	75	80	22	4,5	3mt.	zincato	8.610	1	15
857/2.6.76	75	80	22	4,5	6mt.	zincato	8.610	1	15
857/3.3.76	110	90	25	6	3mt.	zincato	15.210	1	10
857/3.6.76	110	90	25	6	6mt.	zincato	15.210	1	10

Basic

Medium

Magnum

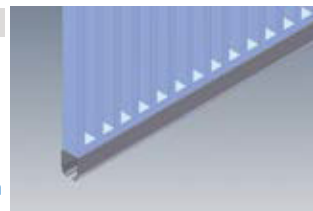

### Art. 859 Guida per cancello autoportante, lunghezza 6mt. in alluminio

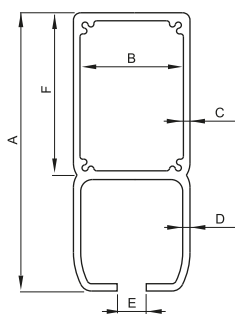

Materiale: Alluminio grezzo

🇬🇧 Aluminium guide for cantilever gate, 6mt. length

🇫🇷 Guide pour portail suspendu en aluminium 6mt. longueur

🇪🇸 Guía para portones suspendidos en aluminio, 6mt. larga

🇩🇪 Aluminium Führungsschiene für Selbsttragende Tore. 6 Meter lang

Art.	A	B	C	D	E	F	Peso(g/mt)	Conf.	Imb.
859	191	71	4,5	5	20	111	8.000	1	8

Aluminium

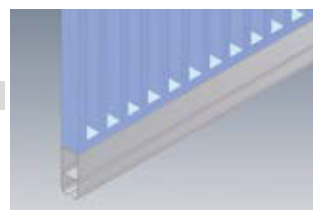

Carrello singolo piccolo medio e grande per cancello autoportante

Art.850

Single small and big cantilever gate carriage

Chariots single petit et gros pour portail suspendu

Carro único, grande y pequeño, para portones suspendidos.

Einzel Laufwagen für freitragende Tore

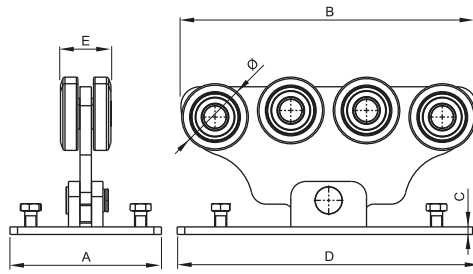

Materiale: Acciaio Verniciato

Art.	A	B	C	D	E	Ø	Peso(g)	Conf.	
850/1	130	200	10	200	44,7	44	4.650	2	Basic
850/2	150	300	10	300	58,6	58	9.360	2	Medium
850/3	200	390	10	400	66,6	88	20.170	1	Magnum

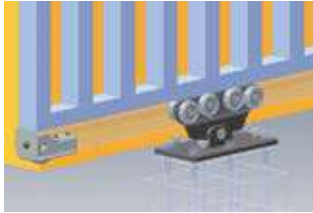

Carrello medio per cancello autoportante

Art. 850/4

Single medium cantilever gate carriage

Chariots single pour portail suspendu

Carro único mediano para portones suspendidos

Mittelgroße Laufwagen für freitragende Tore

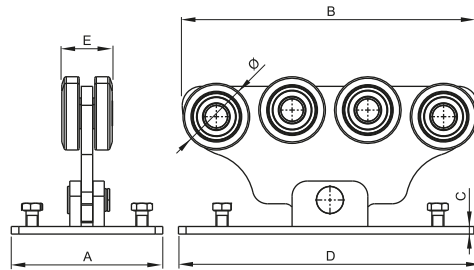

Materiale: Acciaio Verniciato

Art.	A	B	C	D	E	Ø	Peso(g)	Conf.	
850/4	150	300	10	300	59	63,5	8.880	2	Aluminium



Carrello a 5 ruote

Art. 843

5 wheel central hanger for Cantilever gate

Chariot avec 5 galets pour portail suspendu

Carro con 5 ruedas para portones autoportantes

5 rädiger Wagen für freitragende Schiebtore

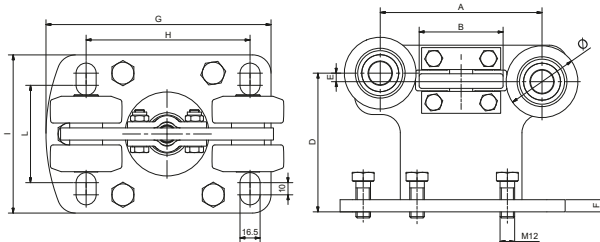

Materiale: Acciaio Verniciato

Art.	A	B	Ø	D	E	F	G	H	I	L	Peso(g)	Conf.	
843/1	105	55	44	67	7	8	135	90	99.8	45	1.957	2	Basic5
843/2	133	69	58	114	7	10	185	135	130	80	4.917	2	Medium5

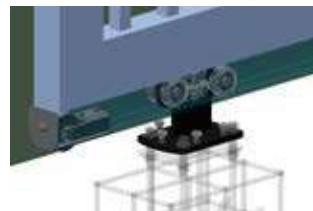



## Art. 851

## Piastra di registrazione per carrello autoportante

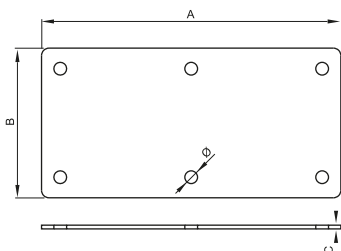

- Adjustable plate for cantilever carriage
- Plaque de réglage pour chariot portail suspendu
- Placa para portones suspendidos
- Einstellungsplatte für freitragende Tore

Materiale: Acciaio Verniciato

Art.	n.fori	A	B	C	Ø	Peso(g)	Conf.	
851/1	4	200	130	5	17	970	2	<b>Basic</b>
851/2	6	300	150	5	17	1.690	2	<b>Medium/Aluminium</b>
851/3	6	400	200	5	17	2.500	2	<b>Magnum</b>

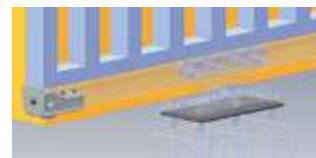

## Art. 848

## Piastra di registrazione per carrello autoportante a 5 ruote

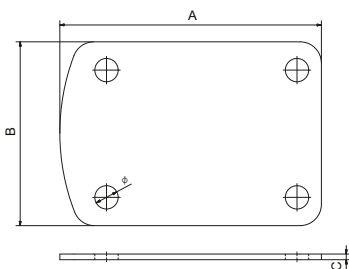

- Adjustable 5 wheel plate for cantilever carriage
- Plaque de réglage pour chariots avec 5 galets pour portail suspendu
- Contraplaca ajustable a 5 ruedas para portones autoportantes
- 5-rädrige Einstellungsplatte für freitragende Tore

Materiale: Acciaio Verniciato

Art.	n.fori	A	B	C	Ø	Peso(g)	Conf.	
848/1	4	135	99.8	4	16.5	383.11	2	<b>Basic5</b>
848/2	4	185	130	4	16.5	705.08	2	<b>Medium5</b>

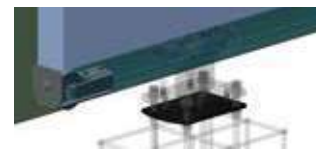

## Art. 852

## Ruota terminale di sostegno

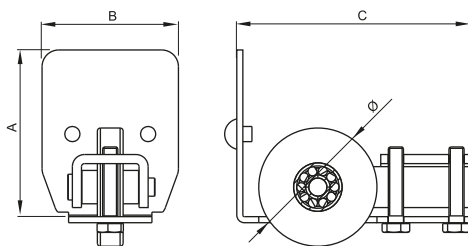

- End support wheel for monorail
- Galet support d'extrémité pour rail
- Rueda terminal de soporte para monocarril
- Endrad für Einfachschiene aus verzinktem Stahl

Materiale: Acciaio Zincato

Art.	A	B	C	Ø	Peso	Conf.	
852/1	60	65	145	65	950	2	<b>Basic/Basic5</b>
852/2	75	80	155	78	1.440	2	<b>Medium/Medium5</b>
852/3	110	90	155	78	1.550	2	<b>Magnum</b>



## Art. 852/4

## Ruota terminale di sostegno per guida in alluminio

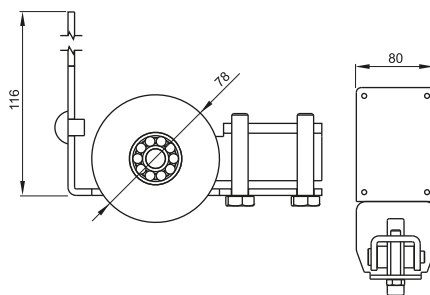

- End support wheel for aluminium monorail
- Galet support d'extrémité pour rail en aluminium
- Rueda terminal de soporte para monocarril en aluminio
- Endrad für Einfachschiene aus Aluminium





Materiale: Acciaio Zincato

Art.	Peso(g)	Conf.	
852/4	1.650	2	<b>Aluminium</b>



**Tirante**

Art. 844

-  *Tension bar for gate regulation*
-  *Tirant pour réglage portails*
-  *Tensor para regulación de puertas*
-  *Ankelbolzen zur Torregulierung*

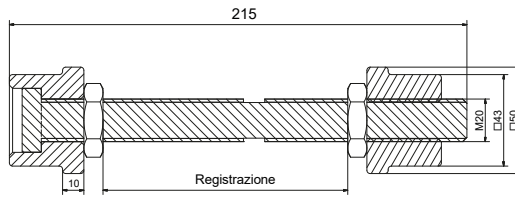





Materiale:	Acciaio Zincato
<b>Peso(g)</b>	<b>Conf.</b>
1.516	1

<b>Art.</b>	<b>844</b>
-------------	------------

**Tirante per fissaggio piastra carrello autoportante**

Art. 853/1

-  *Tie-rod for plate fixing for cantilever carriage*
-  *Tirant pour fixation de la plaque du chariot autoportant*
-  *Varilla tensora para fijación placa del carro autoportante*
-  *Gewindestange für Laufwagen*

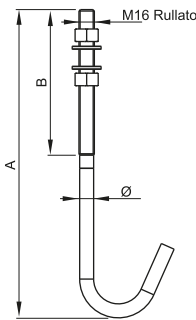

Materiale:	Acciaio Zincato
<b>Peso(g)</b>	<b>Conf.</b>
590	8/12

<b>Art.</b>	<b>A</b>	<b>B</b>	<b>Ø</b>
853/1	320	150	14,5

**Incontro**

Art. 854

-  *End cup*
-  *Butée*
-  *Tope*
-  *Untere Aufaufschu*

**QUESTO ARTICOLO È COMPRESO NEL KIT CANTILEVER vedi pag. 59 - 60**  
**THIS ARTICLE IS INCLUDED IN THE CANTILEVER KIT see pag. 59 - 60**

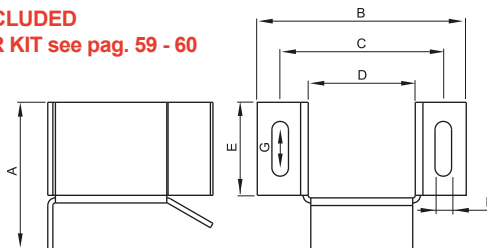

Materiale: Acciaio Zincato

Art.	A	B	C	D	E	F	G	Peso(g)	Conf.
854/1	95	139	108	69	60	13	20	830	4
854/2	115	164	128	84	75	13	30	1.210	2
854/3	155	186	145	96	110	13	35	1.760	2

**Incontro**

Art. 845

-  *End cup*
-  *Butée*
-  *Tope*
-  *Untere Aufaufschu*

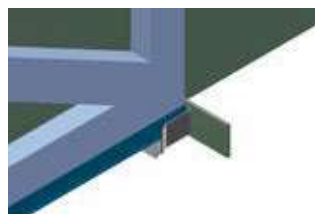
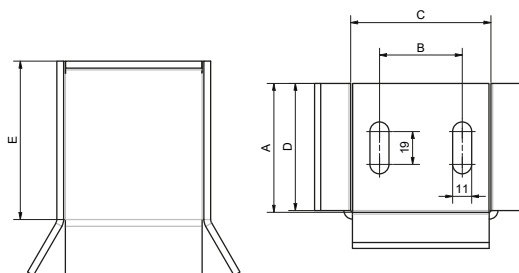

Materiale: Acciaio Zincato

Art.	A	B	C	D	E	Peso(g)	Conf.
845.1	59	33	69	58	82	802	4
845.2	75	48	81	74	92	1102	2
845.3	110	60	96	109	92	1581	2

## Art. 846

## Staffa due olive

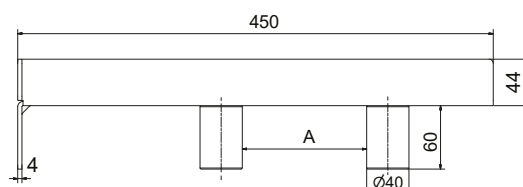

Wall galvanized steel adjustable bracket for guide with two rollers

Support réglable en acier zingué pour guide supérieure avec deux rouleaux

Soporte para guía con dos rodillos en acero cincado

Unterstützung für Einschienenbahn mit zwei Führungsrollen, aus verzinktem Stahl

Materiale: Acciaio Zincato

Art.	A	Peso(g)	Conf.
846	0-360	2.230	2



## Art. 153/4 - 153/5

## Supporto superiore regolabile con 4 olive in nylon o in ottone

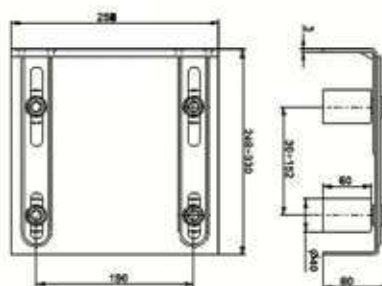

Adjustable roller top guide with 4 nylon or brass rollers

Support guide supérieure réglable avec 4 olives nylon ou laiton

Soporte superior regulable con 4 rodillos de nylon o latón

Höhere Torführungsplatte mit 4 Führungsrolle aus Nylon oder Messing

Materiale: Acciaio Zincato

Art.	Var.	Peso(g)	Conf.
153/4	Nylon	3.738	4
153/5	Ottone	5.458	4

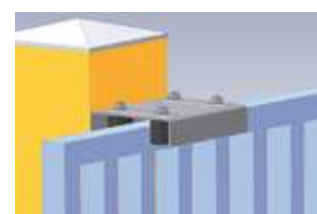

## Art. 162

## Rullo guida in acciaio zincato con oliva cilindrica in nylon

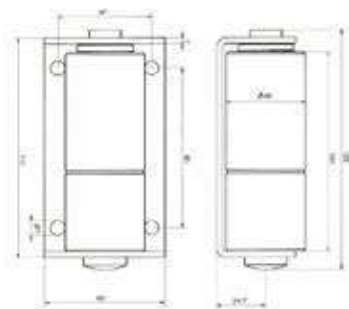

Galvanized steel guide with nylon cylindrical roller

Rouleau guide en acier zingué avec olive cylindrique en nylon

Guiador en acero cincado con rodillo cilíndrico de nylon

Führungsplatte aus verzinktem Stahl mit zylindrische Führungsrolle aus Nylon

Materiale: Acciaio Zincato

Art.	Peso(g)	Conf.
162	540	16



Art. 855/1



Art.	Descrizione	Peso(g)	Q.tà
850/1	Carrello	4.650	2
851/1	Piastra	970	2
853/1	Tirante	590	8



Art.	Descrizione	Peso(g)	Q.tà
854/1	Incontro	830	2



Art.	Descrizione	Peso(g)	Q.tà
852/1	Ruota term.	950	2



Art.	Descrizione	Peso(g)	Q.tà
153/4	Supporto	2.990	2

CANTILEVER System Basic KIT

- Per guida piccola (pag.54)
- For small guide (pag.54)
- Pour guide petite (pag.54)
- Para guía pequeña (pag.54)
- für kleine Führungsschiene (pag.54)

**BasicKit**  
CANTILEVER  
Gate System



Art. 855/2



Art.	Descrizione	Peso(g)	Q.tà
850/2	Carrello	9.360	2
851/2	Piastra	1.690	2
853/1	Tirante	590	12



Art.	Descrizione	Peso(g)	Q.tà
854/2	Incontro	1.210	2



Art.	Descrizione	Peso(g)	Q.tà
852/2	Ruota term.	1.440	2



Art.	Descrizione	Peso(g)	Q.tà
153/4	Supporto	2.990	2

CANTILEVER System Medium KIT

- Per guida media (pag.54)
- For medium guide (pag.54)
- Pour guide moyenne (pag.54)
- Para guía mediana (pag.54)
- für mittelgroße Führungsschiene (pag.54)

**MediumKit**  
CANTILEVER  
Gate System



Art. 855/3



Art.	Descrizione	Peso(g)	Q.tà
850/3	Carrello	20.170	2
851/3	Piastra	2.500	2
853/1	Tirante	590	12



Art.	Descrizione	Peso(g)	Q.tà
854/3	Incontro	1.760	2



Art.	Descrizione	Peso(g)	Q.tà
852/3	Ruota term.	1.550	2



Art.	Descrizione	Peso(g)	Q.tà
153/4	Supporto	3.738	2

CANTILEVER System Magnum KIT

- Per guida grande (pag.54)
- For large guide (pag.54)
- Pour guide grande (pag.54)
- Para guía grande (pag.54)
- für große Führungsschiene (pag.54)

**MagnumKit**  
CANTILEVER  
Gate System



## Art. 855/4



Art.	Descrizione	Peso(g)	Q.tà
850/4	Carrello	8.880	2
851/2	Piastra	1.690	2
853/1	Tirante	590	12



Art.	Descrizione	Peso(g)	Q.tà
854/2	Incontro	1.210	2



Art.	Descrizione	Peso(g)	Q.tà
852/4	Ruota term.	1.490	2



Art.	Descrizione	Peso(g)	Q.tà
153/4	Supporto	3.738	2

## CANTILEVER System Aluminium KIT

- Per guida media (pag.54)
- For medium guide (pag.54)
- Pour guide moyenne (pag.54)
- Para guía mediana (pag.54)
- für mittelgroße Führungsschiene (pag.54)



**AluminiumKit**  
CANTILEVER  
Gate System

## Art. 847/1



Art.	Descrizione	Peso(g)	Q.tà
843/1	Carrello	1.957	2
848/1	Piastra	383	2
853/1	Tirante	590	8



Art.	Descrizione	Peso(g)	Q.tà
854/1	Incontro	830	2



Art.	Descrizione	Peso(g)	Q.tà
852/1	Ruota term.	950	2



Art.	Descrizione	Peso(g)	Q.tà
153/4	Supporto	2.990	2

## CANTILEVER System Basic 5 Kit

- Per guida piccola (pag.54)
- For small guide (pag.54)
- Pour guide petite (pag.54)
- Para guía pequeña (pag.54)
- für kleine Führungsschiene (pag.54)



**Basic5Kit**  
CANTILEVER  
Gate System

## Art. 847/2



Art.	Descrizione	Peso(g)	Q.tà
843/2	Carrello	4.917	2
848/2	Piastra	705	2
853/1	Tirante	590	8



Art.	Descrizione	Peso(g)	Q.tà
854/2	Incontro	1.210	2



Art.	Descrizione	Peso(g)	Q.tà
852/2	Ruota term.	1.440	2



Art.	Descrizione	Peso(g)	Q.tà
153/4	Supporto	2.990	2

## CANTILEVER System Medium 5 Kit

- Per guida media (pag.54)
- For medium guide (pag.54)
- Pour guide moyenne (pag.54)
- Para guía mediana (pag.54)
- für mittelgroße Führungsschiene (pag.54)



**Medium5Kit**  
CANTILEVER  
Gate System

Dimensionamento cancelli autoportanti

Serie	Pmax(kg)	L(m)	I(m)	A(m)	C(m)	F(m)	E(m)	H(m)	D(m)	M(m)
Basic	350	2	0,85	0,35	0,15	1,75	0,50	0,60	0,45	3,70
	350	3	1,20	0,35	0,15	2,10	0,50	0,60	0,45	5,05
	350	4	1,50	0,35	0,15	2,40	0,50	0,60	0,45	6,35
Medium	600	4	1,80	0,40	0,15	2,80	0,60	0,60	0,50	6,75
	600	6	2,50	0,40	0,15	3,50	0,60	0,60	0,50	9,45
	600	8	3,15	0,40	0,15	4,15	0,60	0,60	0,50	12,10
	600	10	3,70	0,40	0,15	4,70	0,60	0,60	0,50	14,65
Magnum	1200	10	4,45	0,45	0,20	5,55	0,80	0,80	0,55	15,55
	1200	12	5,00	0,45	0,20	6,10	0,80	0,80	0,55	18,10
	1200	14	5,45	0,45	0,20	6,55	0,80	0,80	0,55	20,55
	1200	15	5,60	0,45	0,20	6,70	0,80	0,80	0,55	21,70
Aluminium	400	3	1,35	0,40	0,15	2,35	0,60	0,60	0,50	5,30
	400	4	1,75	0,40	0,15	2,75	0,60	0,60	0,50	6,70
	400	5	2,10	0,40	0,15	3,10	0,60	0,60	0,50	8,05
	400	6	2,40	0,40	0,15	3,40	0,60	0,60	0,50	9,35
	400	7	2,70	0,40	0,15	3,70	0,60	0,60	0,50	10,65
	400	8	2,95	0,40	0,15	3,95	0,60	0,60	0,50	11,90

Guida	Carrelli	Supporto	Ruota	Staffa
857/1	850/1	854/1	852/1	153/4
857/1	850/1	854/1	852/1	153/4
857/1	850/1	854/1	852/1	153/4
857/2	850/2	854/2	852/2	153/4
857/2	850/2	854/2	852/2	153/4
857/2	850/2	854/2	852/2	153/4
857/2	850/2	854/2	852/2	153/4
857/3	850/3	854/3	852/3	153/4
857/3	850/3	854/3	852/3	153/4
857/3	850/3	854/3	852/3	153/4
857/3	850/3	854/3	852/3	153/4
859	850/4	854/3	852/4	153/4
859	850/4	854/3	852/4	153/4
859	850/4	854/3	852/4	153/4
859	850/4	854/3	852/4	153/4
859	850/4	854/3	852/4	153/4
859	850/4	854/3	852/4	153/4

**N.B.:** I pesi indicati sono da considerarsi con guida inclusa.  
 Il Kit Cantilever adatto si determina in tabella partendo da peso e luce.  
 Weights shown are with guide included.  
 The suitable Cantilever Kit is determined from the table based on weight and span.

Visiona il video del sistema CANTILEVER sul canale Youtube NOVAFERR [www.youtube.com/user/novaferr](http://www.youtube.com/user/novaferr)

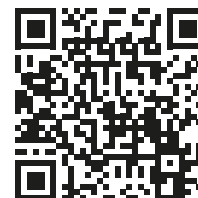

Nel caso in cui le misure di P e L non coincidano con quelle espresse in tabella, utilizzare le formule di seguito o il configuratore presente sul nostro sito [www.novaferr.com](http://www.novaferr.com)

If the measurements of P and L do not coincide with those expressed in the table, use the formulas below or the configurator on our website [www.novaferr.com](http://www.novaferr.com)

**Legenda**

- A** Distanza centro carrello a filo pilastro / centro carrello e filo guida (m) (Basic: 0,35 – Medium: 0,40 – Magnum: 0,45 – Aluminium: 0,40)
- I** Interasse tra i due carrelli  $I_{(min)} = L/3$  (m)
- C** Ingombro battente d'arresto (m) (Basic: 0,15 – Medium: 0,15 – Magnum: 0,20 – Aluminium: 0,15)
- D** Distanza filo basamento centro carrello (m) (Basic: 0,45 – Medium: 0,50 – Magnum: 0,55 – Aluminium: 0,50)
- E** Larghezza del basamento in cemento armato (m) (Basic: 0,50 – Medium: 0,60 – Magnum: 0,80 – Aluminium: 0,60)
- F** Lunghezza del basamento in cemento armato (m)  $F_{(min)} = 2D+I$
- H** Altezza del basamento in cemento armato (m) (Basic: 0,60 – Medium: 0,60 – Magnum: 0,80 – Aluminium: 0,60)
- L** Luce netta di passaggio (m)
- M** Lunghezza totale del cancello e guida (m)  $M = L+2A+I+C$
- N** Spazio utile necessario per funzionamento cancello (m)  $N = 2M - (I+2A)$
- F1** Forza di reazione alla compressione (forza massima a cui è sottoposto il portone) (kgf)  $F1=F2+P$
- F2** Forza di reazione alla trazione (reazione per equilibrare la parte a sbalzo) (kgf)  $F2=(P*(L/2+A))/I$
- W** Peso basamento in cemento armato (kgf)  $W = F*E*H*2200$

Vedere schema pag.63  
 See drawing pag. 63

## Configuratore CANTILEVER

Per individuare rapidamente quali sono gli accessori adatti alle vostre esigenze e per visionare le relative distinte di montaggio vi invitiamo ad utilizzare il nostro

**CONFIGURATORE CANTILEVER**  
sul sito [www.novaferr.com](http://www.novaferr.com)

To quickly identify which accessories are suitable for your needs and to view the relevant assembly lists, we invite you to use our

**CANTILEVER CONFIGURATOR**  
at [www.novaferr.com](http://www.novaferr.com)

### CONFIGURATORE PER IL CALCOLO DI UN CANCELLO AUTOPORTANTE



#### Dati forniti dal cliente

Guida  Zincata

Peso \*  Kg

Luce  mm

\* Va indicato il peso del cancello senza guida

**CALCOLA**

#### Serie

- Articolo 1
- Articolo 2
- Articolo 3
- Articolo 4
- Articolo 5
- Articolo 6

Peso della guida selezionata

Guida selezionata

Riepilogo sul peso dopo il calcolo:

#### Dati utili alla progettazione

A Distanza centro carrello a filo pilastro centro	<input type="range"/>
I Interasse tra i due carrelli (min)	<input type="range"/>
C Ingombro battente d'arresto	<input type="range"/>
D Distanza filo basamento centro carrello	<input type="range"/>
E Larghezza del basamento in cemento armato	<input type="range"/>
F Lunghezza del basamento in cemento armato	<input type="range"/>
H Altezza del basamento in cemento armato	<input type="range"/>
L Luce netta di passaggi	<input type="range"/>
M Lunghezza totale del cancello e guida	<input type="range"/>
N Spazio utile necessario per funzionamento cancello	<input type="range"/>
F1 Forza di reazione alla compressione (forza massima a cui è sottoposto il portone)	<input type="range"/>
F2 Forza di reazione alla trazione (reazione per equilibrare la parte a sbalzo)	<input type="range"/>
W Peso basamento in cemento armato	<input type="range"/>

Applicazione carrello autoportante

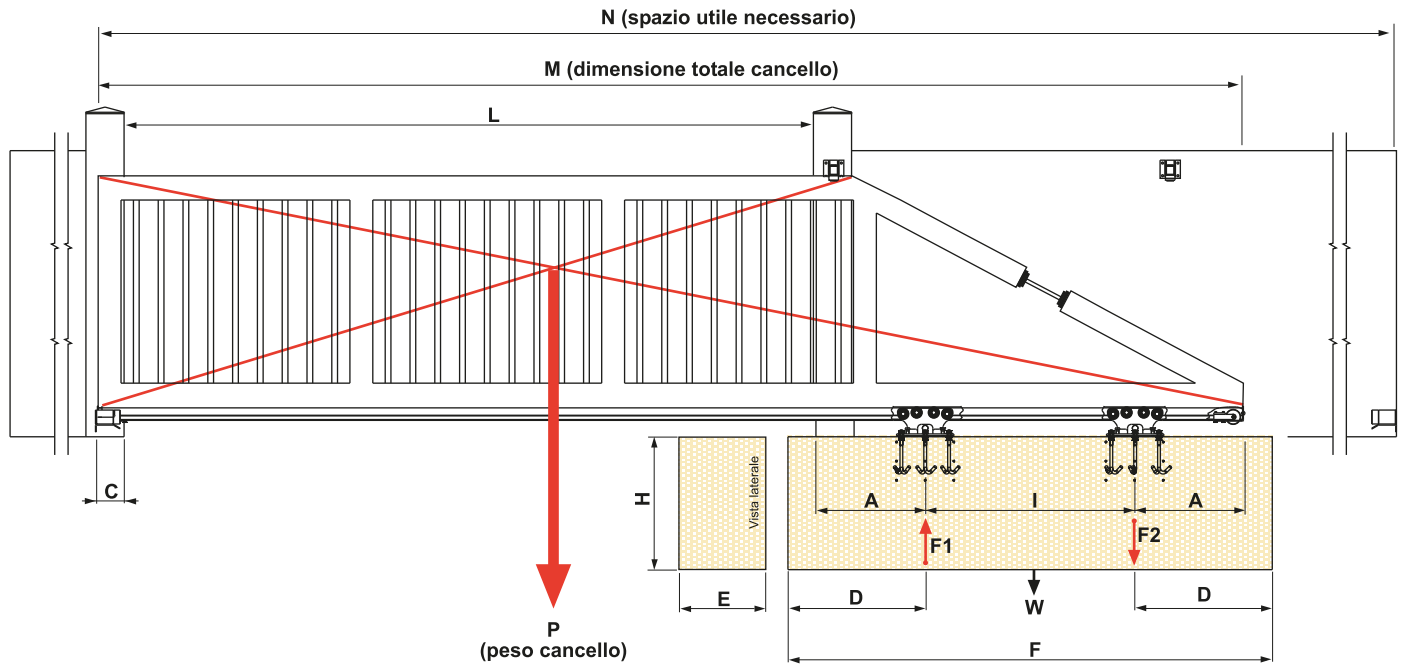

Per portate oltre 800Kg è consigliata la costruzione del cancello come in figura. Data la sua particolare struttura a "traliccio" si nota una maggiore resistenza alla flessione.

For load capacities of more than 800 kg, the construction of the gate as shown in the figure is recommended. Due to its special 'truss' construction, a higher bending resistance is noticeable.

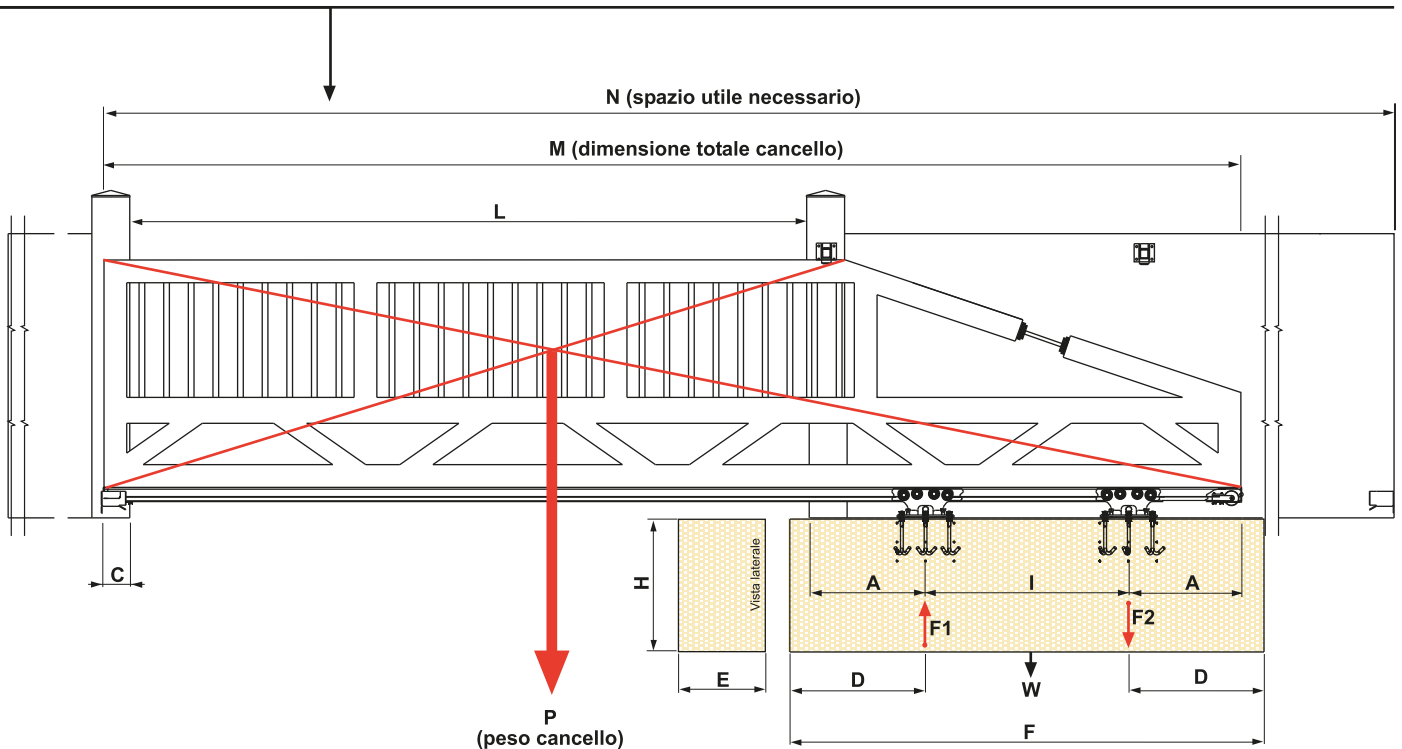



## Materiali da utilizzare per la costruzione del cancello

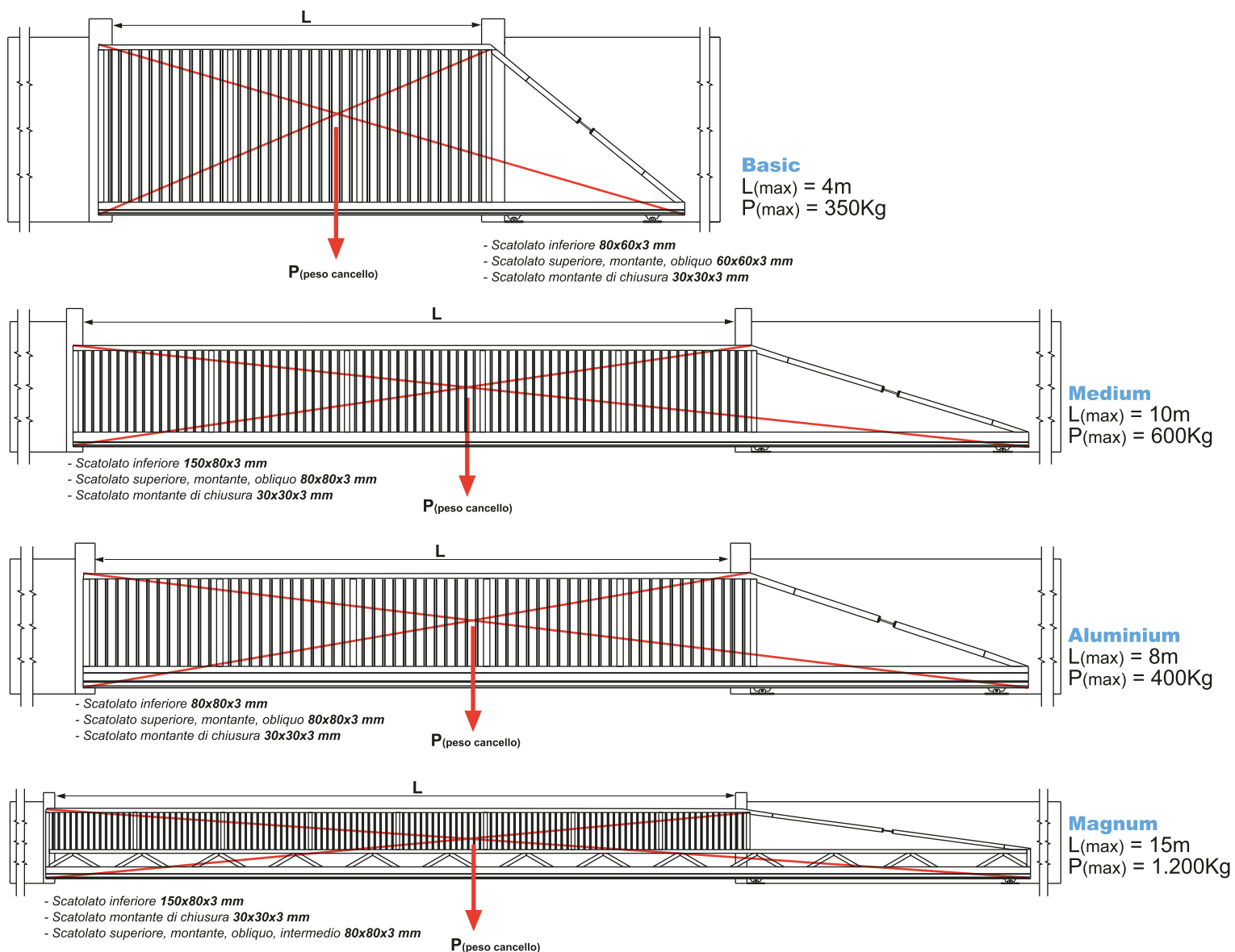

## Analisi sollecitazione - integrità strutturale

Oltre ai test fisici effettuati, come convalida dell'integrità strutturale è stata utilizzata l'applicazione "Analisi sollecitazione di Autodesk Inventor Professional"

In addition to the physical tests performed, the "Stress Analysis of Autodesk Inventor Professional" application was used to validate structural integrity.



Grafico Luce netta/interasse carrelli

L (m) (Luce netta di passaggio)

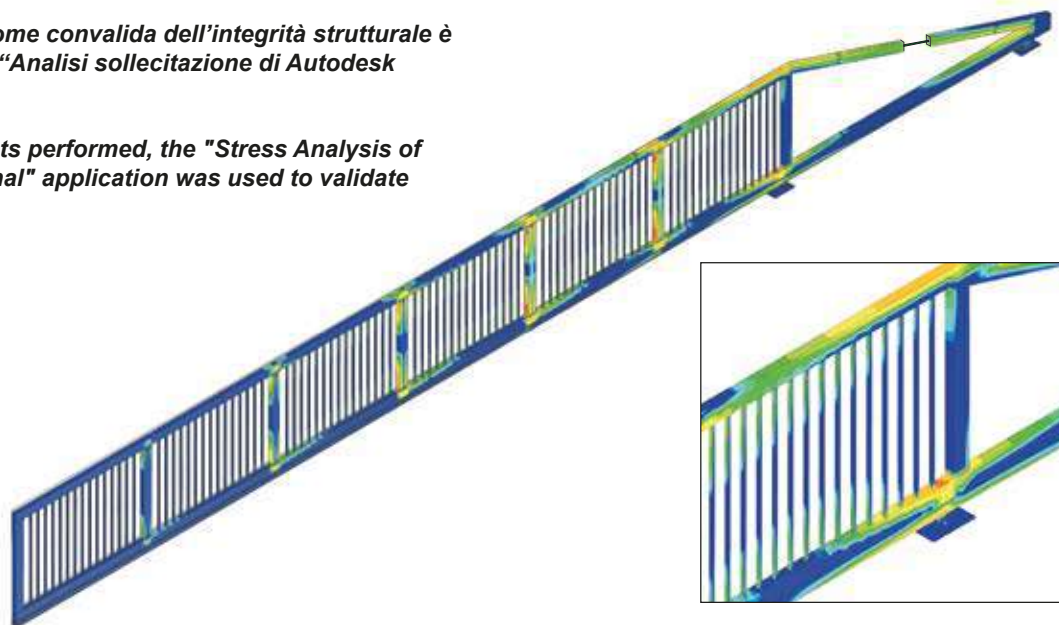
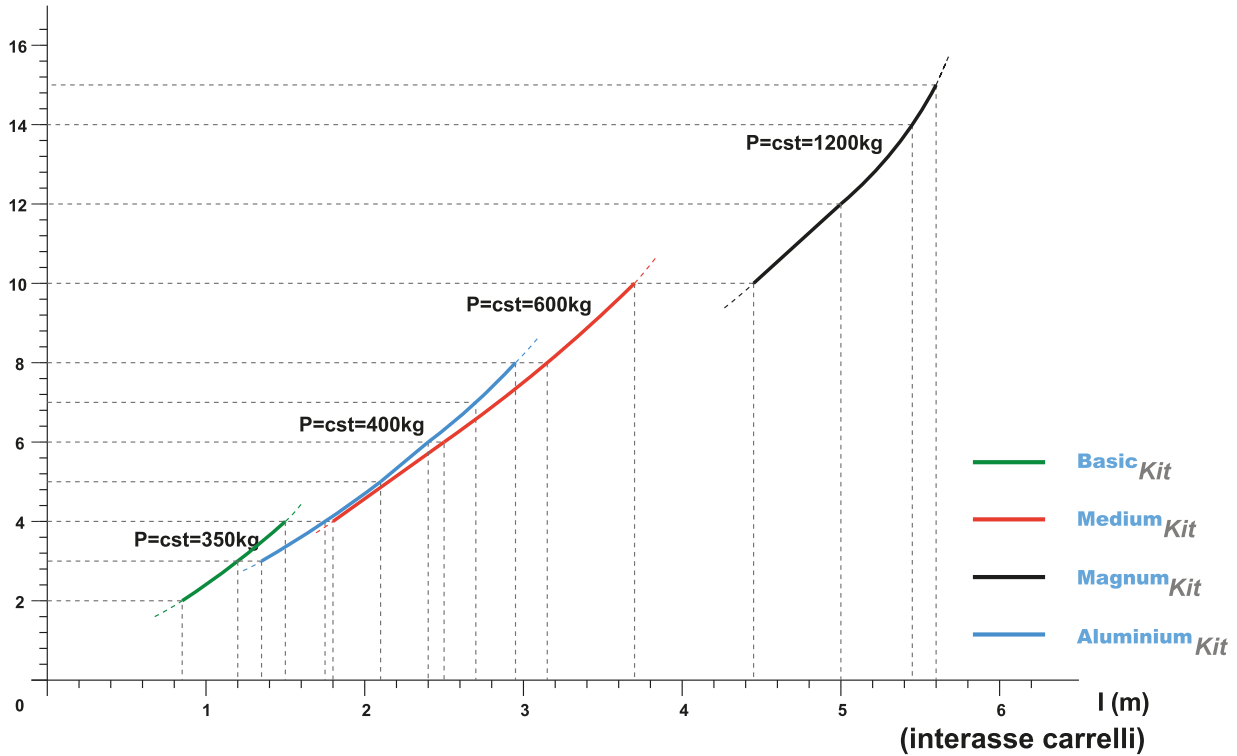

Considerazioni tecniche

La scelta dell'interasse è puramente strategica, Dato lo schema rappresentativo (Vedi Pag. 62):

$$F1 = F2 + P$$

$$F2 = \frac{P \times (L/2 + A)}{I}$$

- Se  $I \rightarrow 0$  ossia se i carrelli sono molto vicini allora  $F2 \rightarrow \infty$  e  $F1 \rightarrow \infty$   
In questo caso bisognerebbe avere  $F1$  elevatissima affinché il sistema autoportante possa funzionare e i due carrelli sopportino la portata a sbalzo.
- Se  $I \rightarrow \infty$  ossia se i carrelli sono molto distanti allora  $F2 \rightarrow 0$  e  $F1 \rightarrow P$   
In questo caso bisognerebbe avere  $F1$  pari al peso del cancello affinché il sistema autoportante possa funzionare e i due carrelli sopportino la portata a sbalzo.

• Consigliabile:

$$I_{(min)} = \frac{L}{3} \quad \text{a comunque} \quad \frac{L}{3} < I < L$$

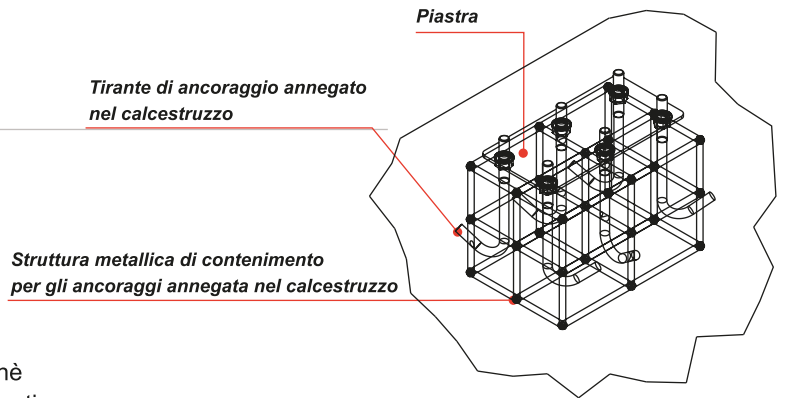

Basamento in calcestruzzo  
(Peso specifico calcestruzzo  $\cong 2200 \text{ kg/m}^3$ )

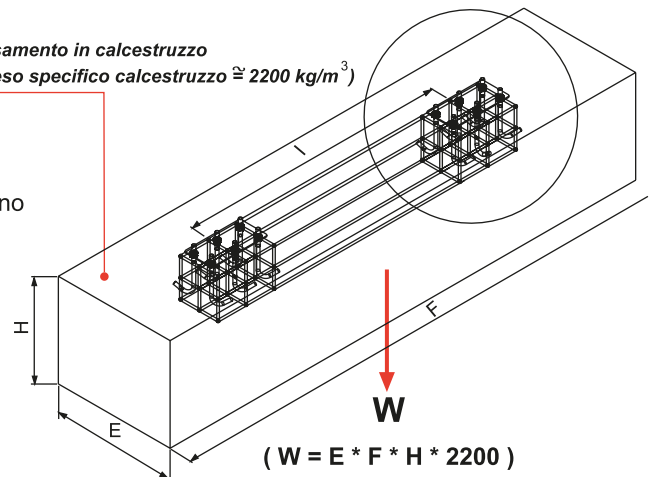

Per un corretto dimensionamento del basamento è opportuno che  $W$  sia  $> 2,5 F2$ , questo per contrastare il peso del cancello a sbalzo

## Supporti e giunzioni per altri usi della guida CANTILEVER

### Art. 840

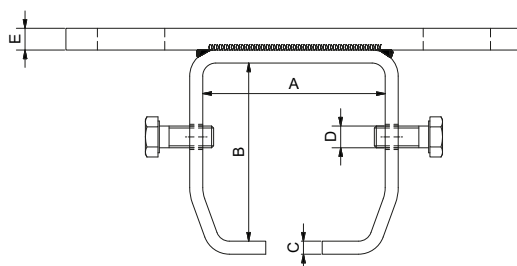

### Supporto a soffitto

Ceiling galvanized steel support bracket for guide

Support au plafond pour rail en acier zingué

Soporte de techo para guía en acero cincado

Deckenstütze für Stahlprofil aus verzinktem Stahl

Materiale: Acciaio Zincato

Art.	A	B	C	D	Piastra	E	Asole	Peso (Kg)	Conf.
840/1	71	65	5	M8	90x170	8	17x28	1.69	8
840/2	86	82	6	M10	100x210	10	21x31	3.02	6
840/3	94,5	113	10	M12	100x225	10	21x31	5.19	4



### Art. 841

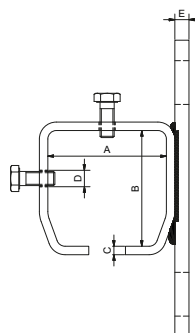

### Supporto a parete

Wall galvanized steel support bracket for guide

Support au mur pour rail en acier zingué

Soporte de pared para guía en acero cincado

Wandstütze für Stahlprofil aus verzinktem Stahl

Materiale: Acciaio Zincato

Art.	A	B	C	D	Piastra	E	Asole	Peso (Kg)	Conf.
841/1	71	65	5	M8	90x170	8	17x28	1.69	8
841/2	86	82	6	M10	100x210	10	21x31	3.02	6
841/3	94,5	113	10	M12	100x225	10	21x31	5.18	4



### Art. 842

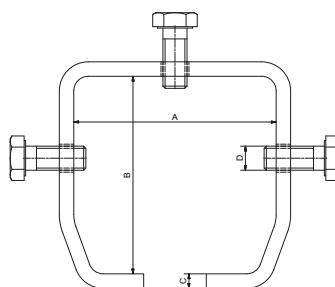

### Giunzione / prolunga

Track connection

Jonction rail

Unión monocarril

Verbindungsstück für Laufschiene

Materiale: Acciaio Zincato

Art.	A	B	C	Lunghezza	D	Peso (Kg)	Conf.
842/1	71	65	5	160	M8	1.7	8
842/2	86	82	6	200	M10	3.15	8
842/3	94,5	113	10	220	M12	7.55	4



Applicazione accessori Sistema ULISSE

Sistema **U**lisse

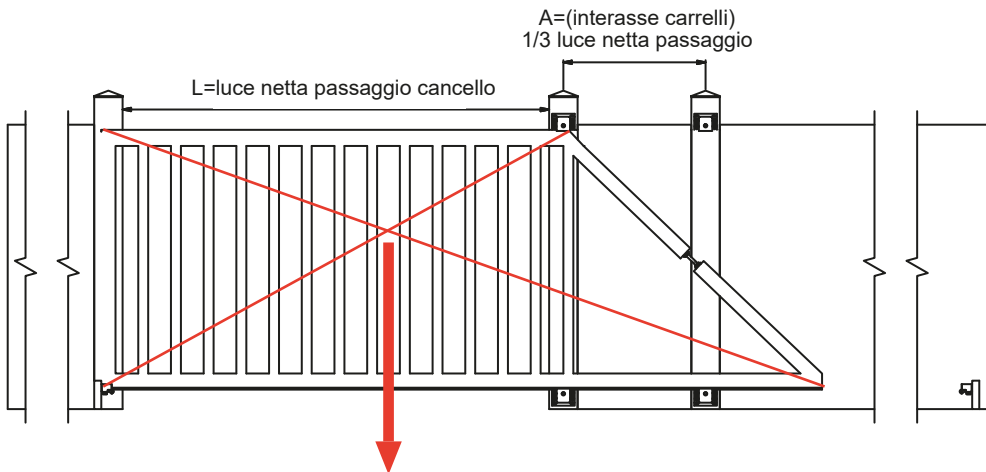
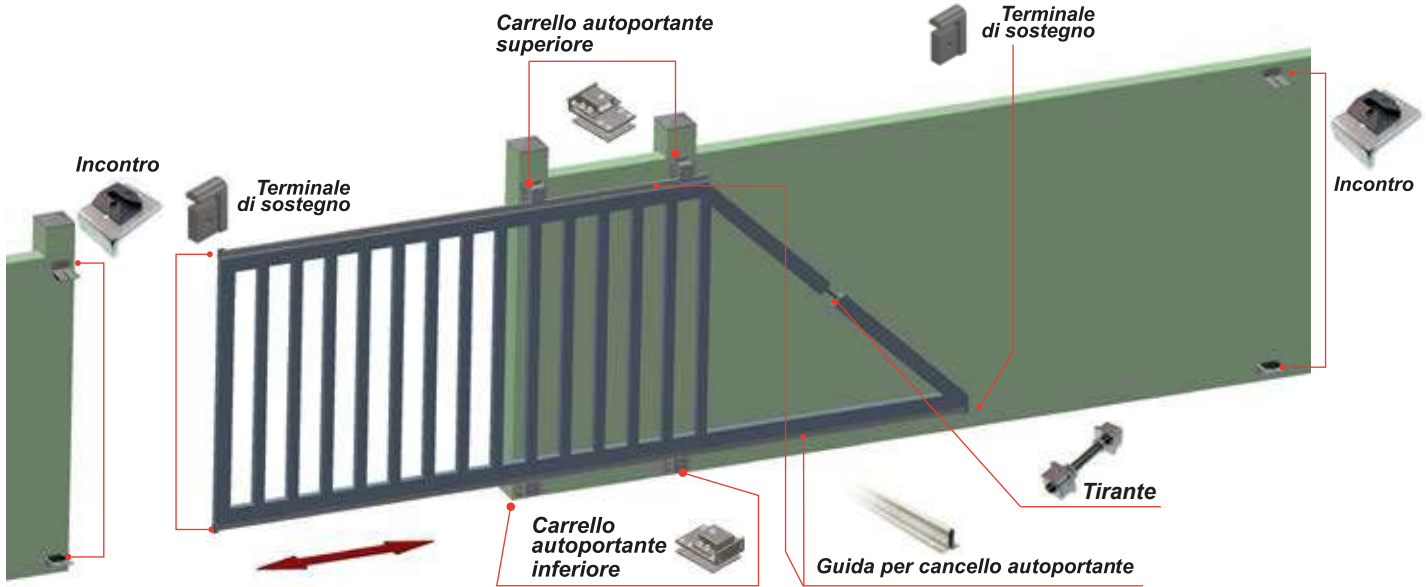

**P= (peso cancello)**  
**P max = 300Kg**  
**L max = 4500mm**

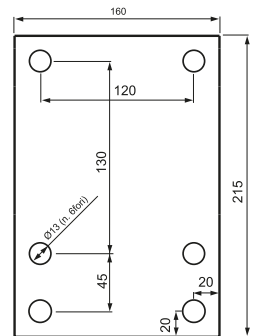

Dima di foratura per pilastro

Art. 3090

## Guida per cancello autoportante in acciaio zincato



**Sistema** *U* **lisse**

Materiale: Acciaio Zincato

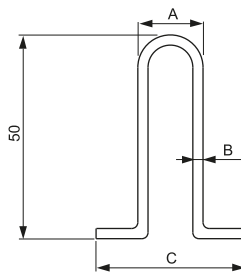

- Galvanized steel guide for cantilever gate
- Guide pour portail suspendu en acier zingué
- Guía para portones suspendidos en acero cincado
- Führungsprofil aus verzinktem Stahl zu zementieren



Art.	A	B	C	L	Peso/m	Imb.	Imb.
3090/20.3/40	20	3	40	3mt	3.260	10	40
3090/20.6/40	20	3	40	6mt	3.260	10	40

Art. 856/1

## Carrello singolo superiore cancello autoportante



**Sistema** *U* **lisse**

Materiale: Acciaio verniciato

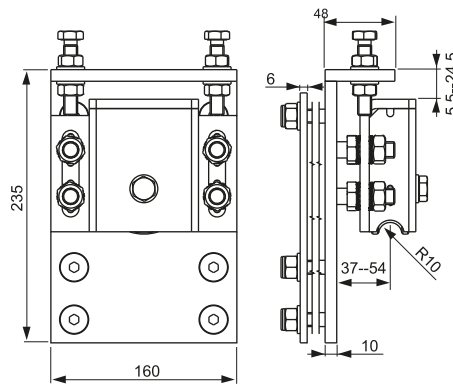

- Single cantilever gate carriage
- Chariots single pour portail suspendu
- Carro solo superior para portones suspendido
- Einzelner, höher Laufwagen für selbsttragende Cantilever Tore



Art.	Peso(g)	Imb.
856/1	8.630	2

Art. 856/2

## Carrello singolo inferiore cancello autoportante



**Sistema** *U* **lisse**

Materiale: Acciaio verniciato

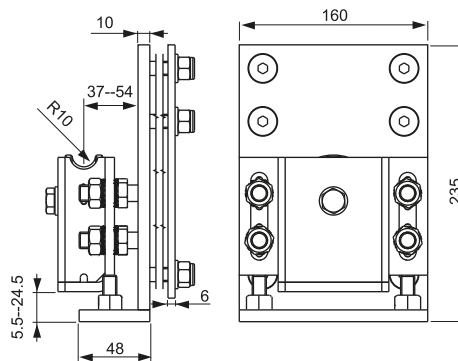



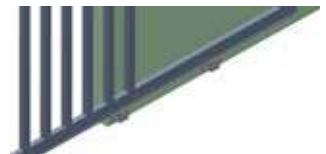

- Single cantilever gate carriage
- Chariots single pour portail suspendu
- Carro solo inferior para portones suspendido
- Einzelner, unterer Laufwagen für selbsttragende Cantilever Tore



Art.	Peso(g)	Imb.
856/2	8.630	2

**Incontro Ulisse**

**Art. 858**

-  *End cup Ulisse System*
-  *Butée pour Ulisse System*
-  *Tope para Ulisse System*
-  *Auflageschu Ulisse System*

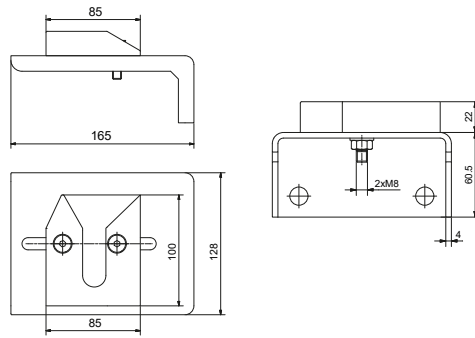
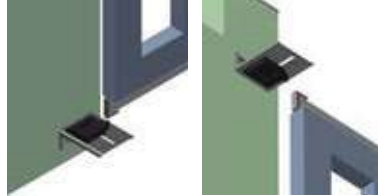





**Sistema Ulisse**

Materiale: Acciaio zincato/nylon

Art.	Peso(g)	Conf.
858	1.090	4

**Terminale di sostegno Ulisse**

**Art. 861**

-  *End plate support for Ulisse System*
-  *Raccordement de support pour Ulisse System*
-  *Terminal de apoyo para Ulisse System*
-  *Unterstützungsendstück für Systeme Ulisse*

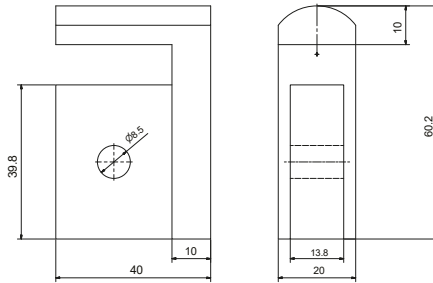
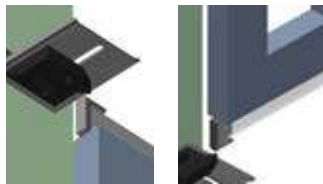

Materiale: Acciaio Zincato

Art.	Peso(g)	Conf.
861	250	4

**Kit Sistema ULISSE**

**Art. 860**

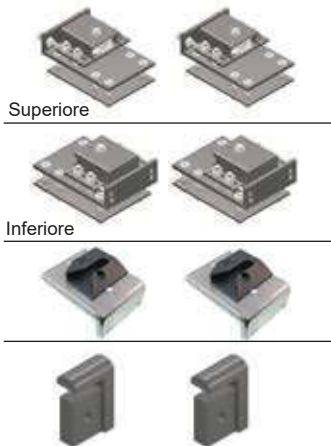

Art.	Descrizione	Peso(g)	Q.tà
856/1	Carrello	8630	2
856/2	Carrello	8630	2
858	Incontro	1090	4
861	Terminale	250	4

-  *Ulisse System Kit*
-  *Kit Système Ulisse*
-  *Kit Sistema Ulisse*
-  *Systeme Ulisse Kit*

**UlisseKit**



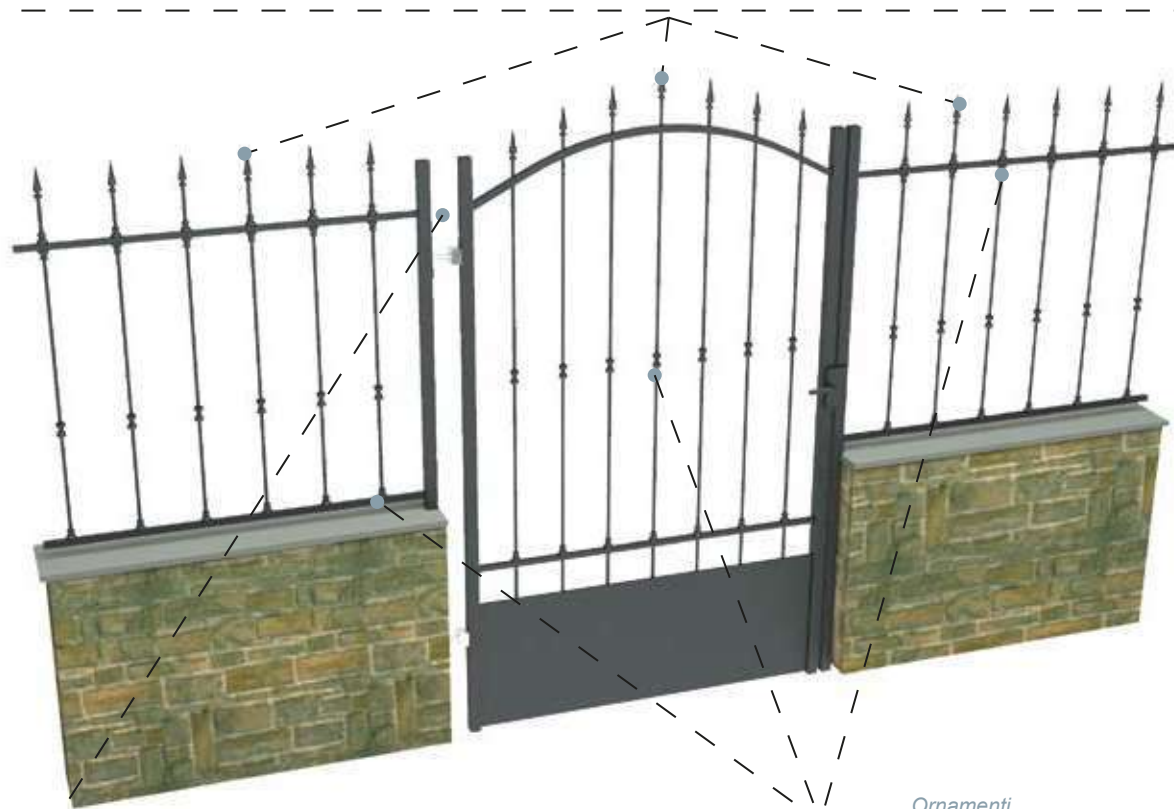
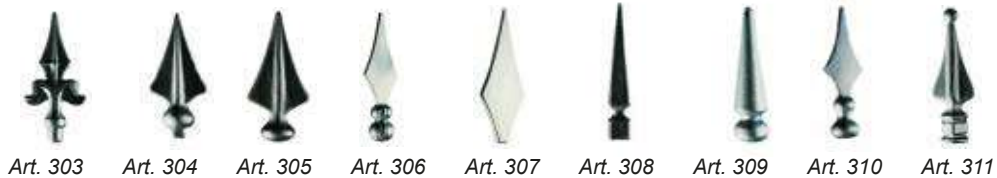

Ornamenti

Compensatori



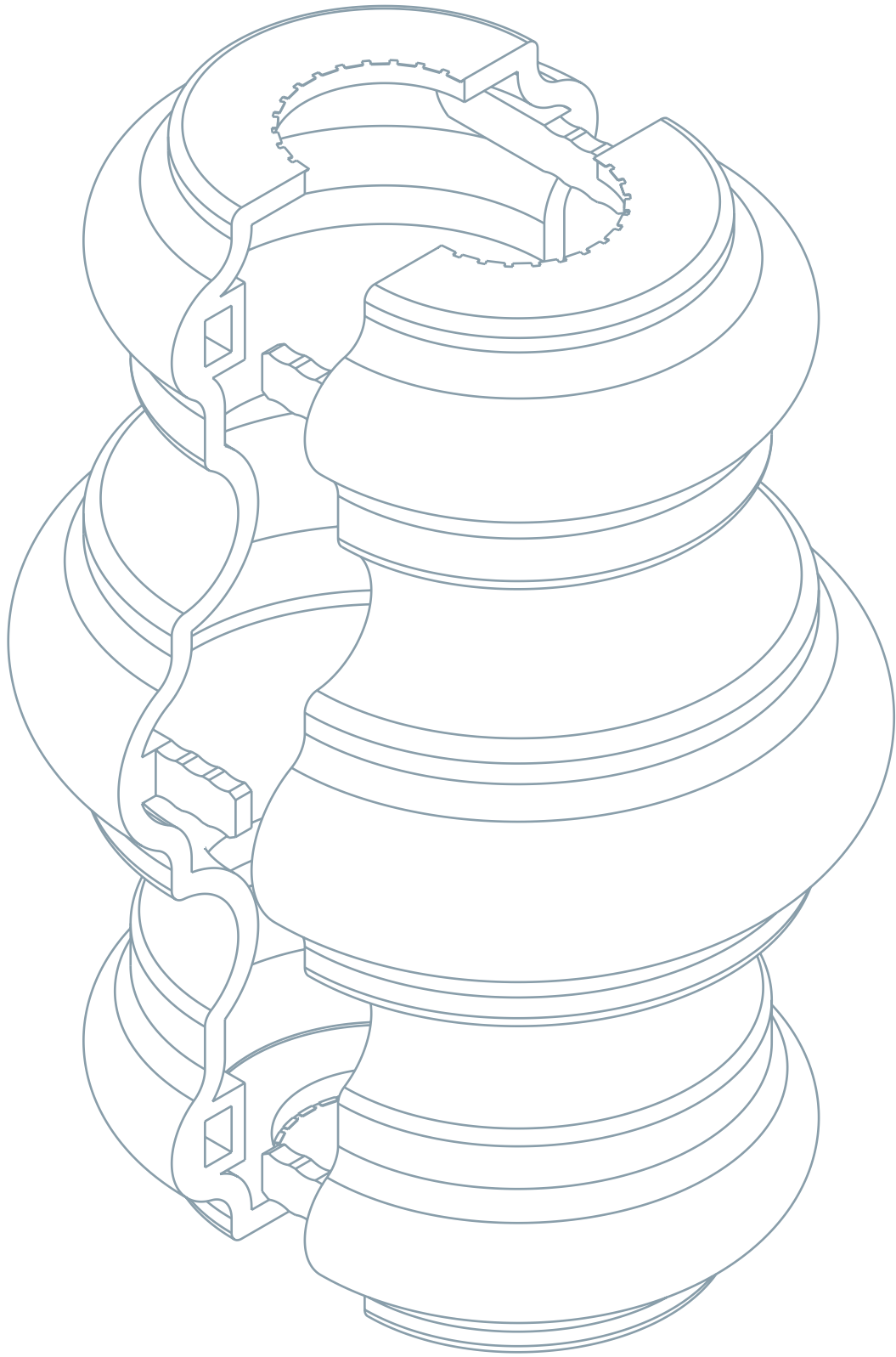

# ORNAMENTI

Ornaments - Ornaments - Adornos - Ornamente





CATALOGO  
N.25



## Art. 306 Lancia modello "Bologna"

**Importato**  
**Imported**







-  Lance "Bologna"
-  Fer de lance "Bologna"
-  Lanza "Bologna"
-  Spitze „Bologna“

Materiale: Acciaio forgiato

Art.	H	L	Ø	Peso(g)	Conf.
306/1	135	40	25	155	50
306/2	165	50	30	270	50
306/3	190	55	34	435	50

## Lancia modello "Pisa"

Art. 311

-  Lance "Pisa"
-  Fer de lance "Pisa"
-  Lanza "Pisa"
-  Spitze „Pisa“



**Importato**  
**Imported**





Materiale: Acciaio forgiato

Art.	H	L	Ø	Peso(g)	Conf.
311/1	125	30	20	220	50
311/2	155	40	30	620	25
311/3	190	50	40	1.170	15

## Art. 307 Lancia modello "Lucca"

**Importato**  
**Imported**







-  Lance "Lucca"
-  Fer de lance "Lucca"
-  Lanza "Lucca"
-  Spitze „Lucca“

Materiale: Acciaio forgiato

Art.	H	L	Base	Peso(g)	Conf.
307	140	60	14x8	215	50

## Lancia modello "Milano"

Art. 310

-  Lance "Milano"
-  Fer de lance "Milano"
-  Lanza "Milano"
-  Spitze „Milano“



**Importato**  
**Imported**





Materiale: Acciaio forgiato

Art.	H	L	Ø	Peso(g)	Conf.
310	200	62	42	685	25

## Art. 308 Lancia modello "Padova"

**Importato**  
**Imported**







-  Lance "Padova"
-  Fer de lance "Padova"
-  Lanza "Padova"
-  Spitze „Padova“

Materiale: Acciaio forgiato

Art.	H	L	Ø	Peso(g)	Conf.
308	160	25	25	370	50

## Lancia modello "Roma"

Art. 300

-  Lance "Roma"
-  Fer de lance "Roma"
-  Lanza "Roma"
-  Spitze „Roma“



**Importato**  
**Imported**





Materiale: Acciaio forgiato

Art.	H	L	Ø	Peso(g)	Conf.
300	155	65	17,5	285	50

## Art. 309 Lancia modello "Venezia"

**Importato**  
**Imported**







-  Lance "Venezia"
-  Fer de lance "Venezia"
-  Lanza "Venezia"
-  Spitze „Venezia“

Materiale: Acciaio forgiato

Art.	H	L	Ø	Peso(g)	Conf.
309/1	110	25	25	240	50
309/2	125	32	32	440	50

## Lancia modello "Torino"

Art. 301

-  Lance "Torino"
-  Fer de lance "Torino"
-  Lanza "Torino"
-  Spitze „Torino“



**Importato**  
**Imported**

Materiale: Acciaio forgiato





Art.	H	L	Ø	Peso(g)	Conf.
301	130	50	15	110	100

Art. 302

Lancia modello "Amalfi"

Importato  
Imported







-  Lance "Amalfi"
-  Fer de lance "Amalfi"
-  Lanza "Amalfi"
-  Spitze „Amalfi“

Materiale: Acciaio forgiato

Art.	H	L	Ø	Peso(g)	Conf.
302/1	120	55	12	145	50
302/2	155	70	16	285	50
302/3	190	90	21,5	540	25

Lancia modello "Firenze"

Art. 312

-  Lance "Firenze"
-  Fer de lance "Firenze"
-  Lanza "Firenze"
-  Spitze „Firenze“



Importato  
Imported

Materiale: Acciaio forgiato





Art.	H	L	Ø	Peso(g)	Conf.
312	200	75	19,5	470	25

Art. 303

Lancia modello "Napoli"

Importato  
Imported







-  Lance "Napoli"
-  Lanza "Napoli"
-  Fer de lance "Napoli"
-  Spitze „Napoli“

Materiale: Acciaio forgiato

Art.	H	L	Ø	Peso(g)	Conf.
303/1	130	60	12	170	50
303/2	155	70	16	295	50

Lancia modello "Capri"

Art. 313

-  Lance "Capri"
-  Fer de lance "Capri"
-  Lanza "Capri"
-  Spitze „Capri“



Importato  
Imported

Materiale: Acciaio forgiato





Art.	H	L	Ø Base	Peso(g)	Conf.
313	140	70	35	400	30

Art. 304

Lancia modello "Siena"

Importato  
Imported







-  Lance "Siena"
-  Fer de lance "Siena"
-  Lanza "Siena"
-  Spitze „Siena“

Materiale: Acciaio forgiato

Art.	H	L	Ø	Peso(g)	Conf.
304	135	60	15	310	50

Lancia modello "Parigi"

Art. 314

-  Lance "Parigi"
-  Fer de lance "Parigi"
-  Lanza "Parigi"
-  Spitze „Parigi“



Importato  
Imported

Materiale: Acciaio forgiato





Art.	H	L	ØSfera	Peso(g)	Conf.
314	250	16,5	20	340	25

Art. 305

Lancia modello "Genova"

Importato  
Imported







-  Lance "Genova"
-  Fer de lance "Genova"
-  Lanza "Genova"
-  Spitze „Genova“

Materiale: Acciaio forgiato

Art.	H	L	Ø	Peso(g)	Conf.
305	125	60	35	265	50

Lancia modello "Praga"

Art. 315

-  Lance "Praga"
-  Fer de lance "Praga"
-  Lanza "Praga"
-  Spitze „Praga“



Importato  
Imported

Materiale: Acciaio forgiato

Art.	H	L	Peso(g)	Conf.
315	175	60	396	25

Art. 316

Lancia modello "Vienna"

Importato  
Imported



-  Lance "Vienna"
-  Fer de lance "Vienna"
-  Lanza "Vienna"
-  Spitze „Vienna“

Materiale: Acciaio forgiato

Art.	H	L	Peso(g)	Conf.
316	215	70	615	25

Lancia modello "Ginevra"

Art. 317

 Lance "Ginevra"

 Fer de lance "Ginevra"

 Lanza "Ginevra"

 Spitze „Ginevra“



Importato  
Imported

Materiale: Acciaio forgiato





Art.	H	L	Ø	Peso(g)	Conf.
317	230	65	16	660	25

Art. 350

Sfera stampata liscia

Importato  
Imported



-  Plain pressed ball
-  Bille estampée lisse
-  Bola estampada lisa
-  Kugel aus gepresstem Stahl

Materiale: Acciaio stampato

Art.	Ø	Peso	Conf.
350/15	15	14	100
350/20	20	35	50
350/25	25	65	50
350/30	30	110	50
350/35	35	180	50
350/40	40	265	50
350/50	50	515	30
350/60	60	890	20
350/70	70	1.420	12
350/80	80	2.110	8
350/90	90	3.000	6
350/100	100	4.150	4

Borchia stampata, foro quadro

Art. 351

 Pressed stud, square hole

 Bossage moulé, trou carré

 Guarnicion torneada, agujero cuadrado

 Gepresster Bolzen mit verkannt Durchgangsbohrung



Importato  
Imported

Materiale: Acciaio forgiato





Art.	H	L	Ø	Peso(g)	Conf.
351/1	21	40	12,5	130	100
351/2	21	40	14,5	110	100
351/3	21	40	16,5	100	100

Art. 352

Borchia tornita, foro tondo

Importato  
Imported



-  Turned stud, round hole
-  Bossage façonné, trou rond
-  Guarnicion torneada, agujero redondo
-  Drehbolzen mit rundlicher Durchgangsbohrung

Materiale: Acciaio tornito

Art.	H	L	Ø	Peso(g)	Conf.
352/1	21	40	12,5	148	100
352/2	21	40	14,5	140	100
352/3	21	40	16,5	126	100
352/4	21	40	18,5	118	100

Borchia stampata, foro tondo

Art. 361

 Pressed stud, round hole

 Bossage moulé, trou rond

 Guarnicion estampada, agujero redondo

 Gepresster Bolzen mit rundlicher Durchgangsbohrung



Importato  
Imported





Materiale: Acciaio tornito

Art.	H	L	Ø	Peso(g)	Conf.
361/1	21	40	12,5	140	100
361/2	21	40	14,5	130	100
361/3	21	40	16,5	120	100

Art. 356 - 357 Ornamento semplice foro tondo

Importato  
Imported



-  *Pressed simple round ornament, round hole*
-  *Ornement rond simple moulé trou rond*
-  *Ornamento simple estampado redondo agujero redondo*
-  *Gepresster Einzelbolzen mit rundlicher Durchgangsbohrung*





Materiale: Acciaio forgiato

Art.	H	L	Ø	Peso(g)	Conf.
356/1	38	40	12,5	180	50
356/2	38	40	14,5	170	50
356/3	38	40	16,5	145	50
357/1	50	50	16,5	330	25
357/2	50	50	18,5	310	25

Orn.to semplice quadrato, foro quadro Art. 353

Importato  
Imported



-  *Simple square ornament, square hole*
-  *Ornement carré simple, trou carré*
-  *Ornamento simple cuadrado agujero cuadrado*
-  *Gepresster Einzelbolzen mit Vierkantdurchgangsbohrung*





Materiale: Acciaio forgiato

Art.	H	L	Ø	Peso(g)	Conf.
353/1	50	45	14,5	360	50
353/2	50	45	16,5	332	50
353/3	45	40	12,5	258	50
353/4	45	40	14,5	236	50

Art. 358 - 359 Ornamento doppio, foro tondo

Importato  
Imported



-  *Pressed double round ornament, round hole*
-  *Ornement rond double moulé, trou rond*
-  *Ornamento doble estampado redondo, agujero redondo*
-  *Gepresster Doppelbolzen mit rundlicher Durchgangsbohrung*





Materiale: Acciaio forgiato

Art.	H	L	Ø	Peso(g)	Conf.
358/1	65	40	12,5	285	100
358/2	65	40	14,5	260	100
358/3	65	40	16,5	235	100
359/1	80	50	16,5	540	25
359/2	80	50	18,5	515	25

Orn.to doppio quadrato, foro quadro Art. 354

Importato  
Imported



-  *Double square ornament, square hole*
-  *Ornement carré double, trou carré*
-  *Ornamento doble cuadrado, agujero cuadrado*
-  *Gepresster Doppelbolzen mit Vierkantdurchgangsbohrung*

Materiale: Acciaio forgiato

Art.	H	L	Ø	Peso(g)	Conf.
354/1	90	45	14,5	672	25
354/2	90	45	16,5	606	25
354/3	70	40	12,5	422	25
354/4	70	40	14,5	374	25

Art. 355 - 1355 Ornamento semplice tornito



-  *Turned simple round ornament, round hole*
-  *Ornement rond simple façonné au tour, trou rond*
-  *Ornamento simple torneado redondo, agujero redondo*
-  *Einzelbolzen mit rundlicher Durchgangsbohrung*





Materiale: Acciaio tornito

Art.	H	L	Ø	Peso(g)	Conf.
355/1	30	36	12,5	148	100
355/2	30	36	14,5	148	100
355/3	30	36	16,5	148	100
355/4	30	36	18,5	148	100
1355/1	30	36	20,5	148	100

—INOX

Ornamento doppio tornito Art. 360 - 1360



-  *Turned double round ornament, round hole*
-  *Ornement rond double façonné au tour, trou rond*
-  *Ornamento doble torneado redondo, agujero redondo*
-  *Doppelbolzen mit rundlicher Durchgangsbohrung*

Materiale: Acciaio tornito

Art.	H	L	Ø	Peso(g)	Conf.
360/1	60	36	12,5	240	50
360/2	60	36	14,5	216	50
360/3	60	36	16,5	194	50
360/4	60	36	18,5	166	50
1360/1	60	36	20,5	240	50

—INOX

## Art. 1362 Borchia tornita, foro tondo INOX



-  *Turned stud, round hole INOX*
-  *Bossage façonné, trou rond, INOX*
-  *Guarnición torneada, agujero redondo, INOX*
-  *Drehbolzen mit Rundloch aus Edelstahl*

Materiale: Acciaio INOX

Art.	H	L	Ø	Peso(g)	Conf.
1362/1	35	34	25	80	50
1362/2	25	25	20	26	50

## Borchia tornita, foro tondo INOX Art. 1364







-  *Turned stud, round hole INOX*
-  *Bossage façonné, trou rond, INOX*
-  *Guarnición torneada, agujero redondo, INOX*
-  *Drehbolzen mit Rundloch aus Edelstahl*

Materiale: Acciaio INOX

Art.	H	L	Ø	Peso(g)	Conf.
1364/1	35	40	25	80	50
1364/2	28	31	20	65	50

## Art. 1367 Lancia tornita INOX







-  *Turned lance, INOX*
-  *Lance façonné, INOX*
-  *Lanza torneada, INOX*
-  *Drehspitze aus Edelstahl*

Materiale: Acciaio INOX

Art.	H	L	Ø	Peso(g)	Conf.
1367/1	80	30	22	290	20
1367/2	62	22	17	135	25

## Lancia tornita INOX Art. 1365







-  *Turned lance, INOX*
-  *Lance façonné, INOX*
-  *Lanza torneada, INOX*
-  *Drehspitze aus Edelstahl*

Materiale: Acciaio INOX

Art.	H	L	Ø	Peso(g)	Conf.
1365/1	76	24	22	155	25
1365/2	63	20	17	85	25

## Art. 318 Ornamento semplice, foro tondo-quadro







-  *Plastic simple ornament, round or square hole*
-  *Ornement simple en plastique, trou rond ou carré*
-  *Ornamento simple en nylon, agujero redondo*
-  *Bolzen mit rundlicher oder vierkantlicher Durchgangsbohrung*

Materiale: Plastica verniciabile

Art.	H	L	Ø	∅	Peso(g)	Conf.
318/1	38	40	12,5		35	200
318/2	38	40	14,5		35	200
318/3	38	40	16,5		35	200
318/4	38	40		12,5	35	200

## Ornamento doppio, foro tondo-quadro Art. 319



-  *Plastic double ornament, round or square hole*
-  *Ornement double en plastique, trou rond ou carré*
-  *Ornamento doble en nylon, agujero redondo o cuadrado*
-  *Doppelbolzen mit rundlicher oder vierkantlicher Durchgangsbohrung*

Materiale: Plastica verniciabile

Art.	H	L	Ø	∅	Peso(g)	Conf.
319/1	65	40	12,5		68	200
319/2	65	40	14,5		68	200
319/3	65	40	16,5		68	200
319/4	65	40		12,5	68	200

Compensatore ornamentale tornito

Art. 320

Turned ornamental corrector Ø30

Dispositif correcteur ornamental Ø30

Compensador ornamental torneado Ø30

Dekor-Kompensator, gedreht Ø 30

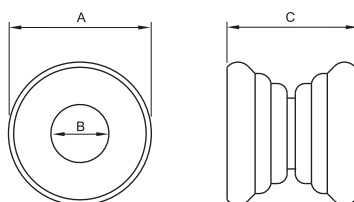

Materiale: Acciaio grezzo / Acciaio zincato

Art.	A	B	C	Finitura	Peso(g)	Conf.
320/1	30	12,5	32 - 40	grezzo	90	50
320/2	36	14,5	32 - 40	grezzo	130	50
320/1.76	30	12,5	32 - 40	zincato	90	50
320/2.76	36	14,5	32 - 40	zincato	130	50



Compensatore ornamentale tornito

Art. 321

Turned ornamental corrector Ø36

Dispositif correcteur ornamental Ø36

Compensador ornamental torneado Ø36

Dekor-Kompensator, gedreht Ø 36

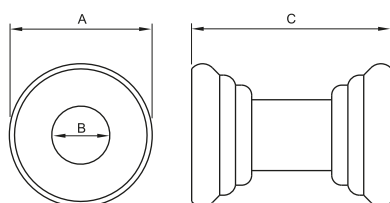

Materiale: Acciaio grezzo / Acciaio zincato

Art.	A	B	C	Finitura	Peso(g)	Conf.
321/1	30	12,5	50 - 60	grezzo	100	50
321/2	36	14,5	50 - 60	grezzo	140	50
321/1.76	30	12,5	50 - 60	zincato	100	50
321/2.76	36	14,5	50 - 60	zincato	140	50



Compensatore

Art. 330

Turned ornamental corrector

Dispositif correcteur ornamental

Compensador ornamental torneado

Kompensator

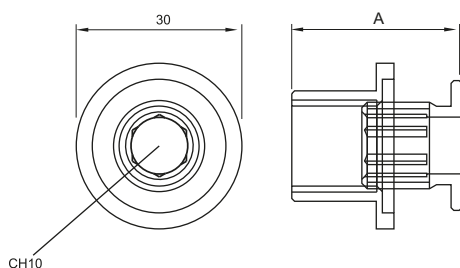

Materiale: Acciaio zincato

Art.	A	Peso(g)	Conf.
330/1	18 - 30	45,27	100
330/2	30 - 52	69	100

# NOVA-FERR srl

ACCESSORI VARI PER CANCELLI E ALTRI USI  
VARIOUS ACCESSORIES FOR GATES AND OTHER USES

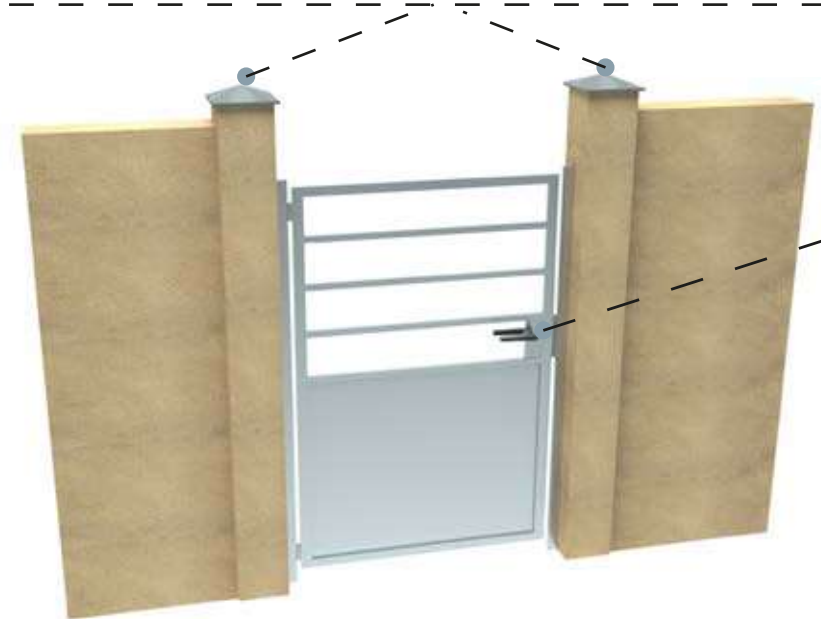

### Maniglie

Art. 270



Art. 271



### Catenacci



Art. 259



Art. 260



Art. 261



Art. 263



Art. 264



Art. 252

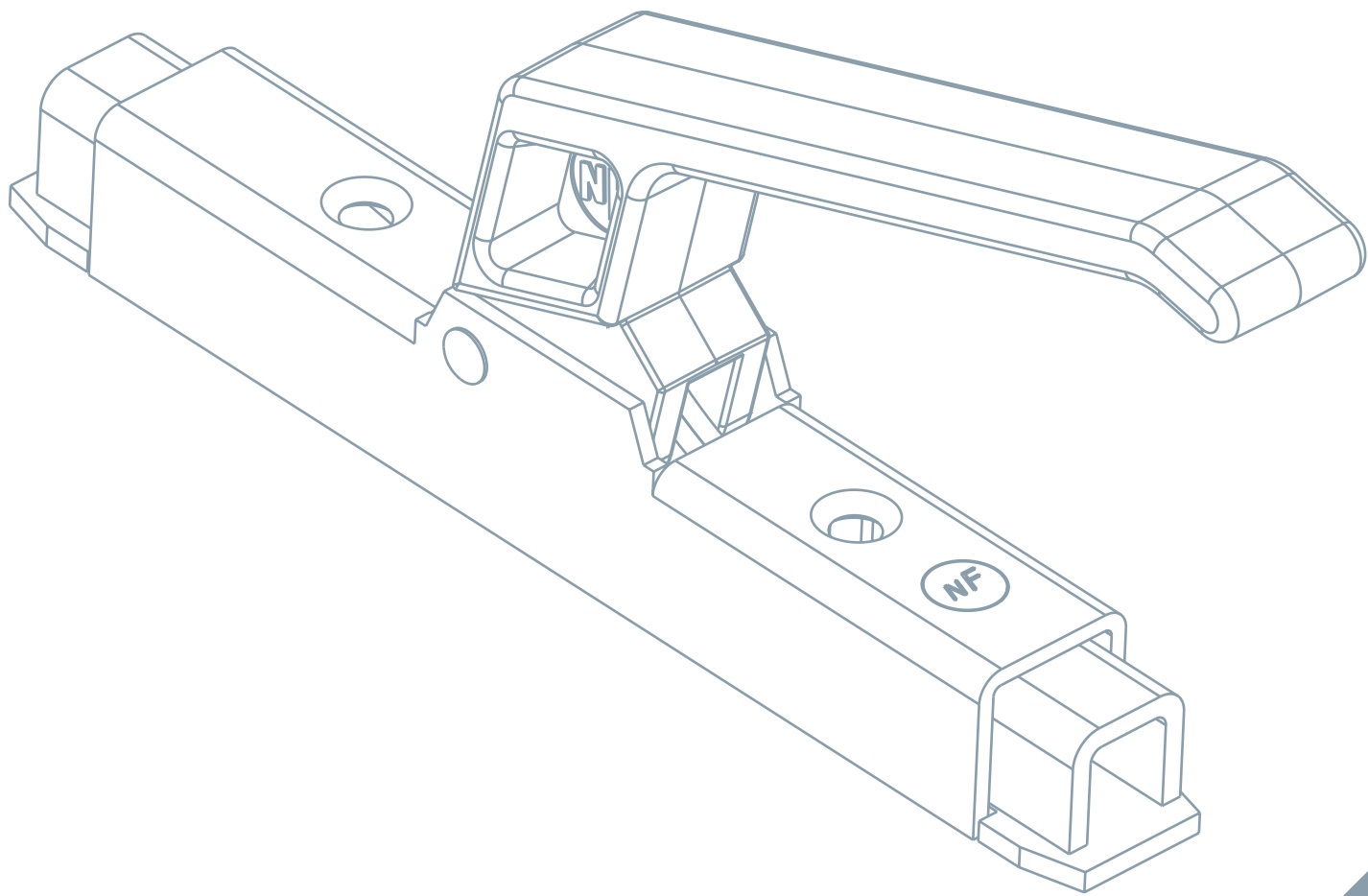

# ACCESSORI VARI PER CANCELLI E ALTRI USI

Various accessories for gates and other uses  
Divers accessoires pour portails et autres usages  
Varios accesorios para puertas y otros usos  
Verschiedenes Zubehör für Tore und  
andere Anwendungen

**CATALOGO  
N.25**



## Art. 123

## Paletto ad incasso singola azione, filetto 8MA

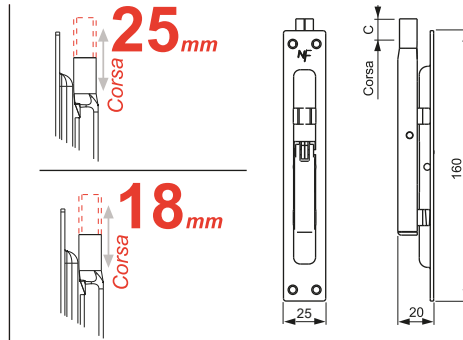

Bolt to be recessed thread 8MA

Verrou à encaisser filet 8MA

Pestillo a encaje rosca 8MA

Einsteck-Türkantenriegel mit Kipphebel und Gewinde 8MA. Einzelbewegung

Materiale: Acciaio zincato

Art.	Leva	Frontale	C	Peso(g)	Conf.
123.1.25	ferro	zincato	25	140	12
123.3.25	lamiera ott.	zincato	25	140	12
123.1.25.90	ferro	vr.nero	25	150	12
123.1.18	ferro	zincato	18	140	12
123.3.18	ottone	zincato	18	150	12
123.3/1.18	lamiera ott.	zincato	18	150	12



## Art. 128

## Paletto ad incasso doppia azione, filetto 8MA

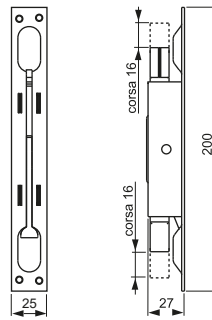

Double lever action gripping to be enclosed, thread 8MA

Verrou à encaisser à double action, filet 8MA

Pestillo a encaje con doble acción, rosca 8MA

Einsteck-Türkantenriegel mit Kipphebel und Gewinde 8MA. Doppelbewegung

Materiale: Acciaio zincato

Art.	Leva	Peso(g)	Conf.
128	ottone	290	15

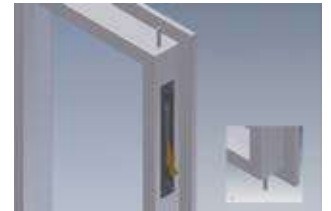

## Art. 272

## Cariglione per aste esterne 10x10mm



**Jolly**

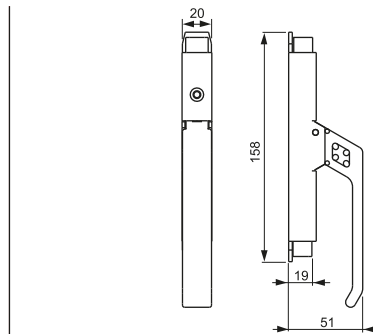

Steel lock for exterior bars 10x10 mm

Fermeture pour barres extérieures 10x10 mm

Cremona para brazos exteriores 10x10mm

Stahl-Treibriegel für Stangen 10x10mm





Materiale: Acciaio Zincato

Art.	Peso(g)	Conf.
272	430	12



**Catenaccio verticale pesante a saldare zincato**

Art. 258

-  Galvanised vertical heavy bolt to be welded
-  Verrou vertical lourd zingué à souder
-  Pestillo vertical pesado zincado, a soldar
-  Massiver, lackierter Hangschlossriegel aus verzinktem Stahl. Horizontal, zum Schweißen

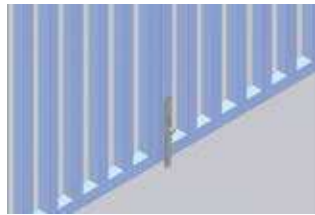
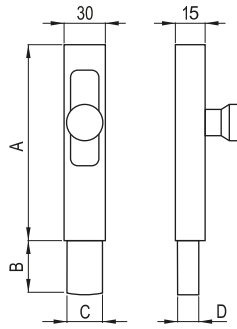





Art.	A	B	C	D	Peso(g)	Conf.
258/20	200	48	25	10	360	12
258/25	250	48	25	10	470	12
258/30	300	48	25	10	570	12
258/40	400	48	25	10	740	10
258/50	500	48	25	10	930	10
258/60	600	48	25	10	1.090	8
258/80	800	48	25	10	1.450	2

Materiale: Acciaio zincato

**Catenaccio trasversale piccolo verniciato**

Art. 259

-  Varnished transverse small bolt
-  Verrou transversal petit verni
-  Pasador transversal pequeño barnizado
-  Klein, lackierter Hangschlossriegel. Horizontal

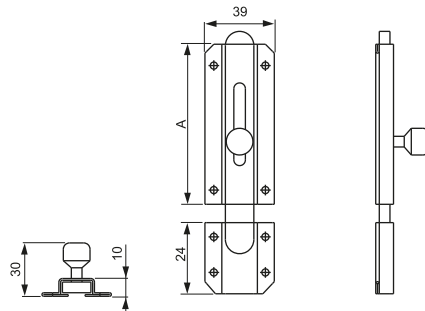





Art.	A	Peso(g)	Conf.
259/50	55	90	20
259/70	70	116	20
259/90	90	130	20

Materiale: Acciaio verniciato 8017

**Catenaccio trasversale grande verniciato**

Art. 260

-  Varnished transverse big bolt
-  Verrou transversal grand verni
-  Pasador transversal grande barnizado
-  Groß, lackierter Hangschlossriegel

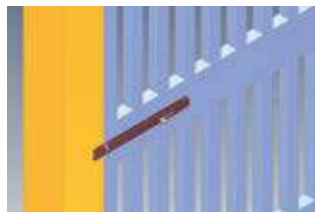
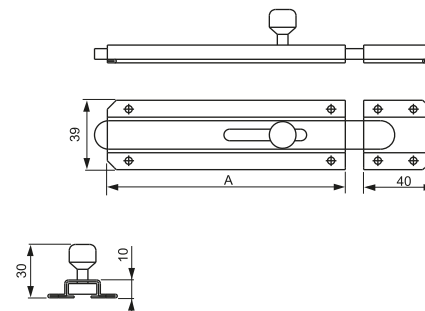





Art.	A	Peso(g)	Conf.
260/15	150	200	12
260/20	200	260	12
260/25	250	310	12
260/30	300	360	12
260/40	400	480	6
260/50	500	580	8

Materiale: Acciaio verniciato 8017

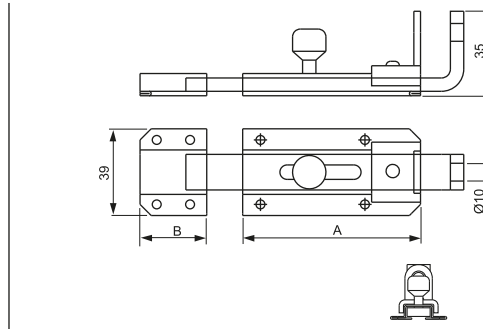
## Art. 263

## Catenaccio portalucchetto trasversale leggero



-  *Transverse light padlock bolt*
-  *Verrou transversal porte-cadenas léger*
-  *Pestillo porta candado trasversal ligero*
-  *Leichter horizontaler Schlossriegel*

Materiale: Acciaio zincato



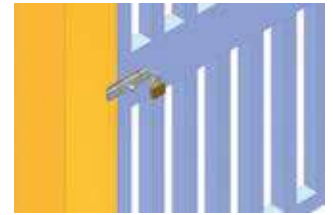

Art.	A	B	Peso(g)	Conf.
263/8	75	24	150	12
263/12	130	40	230	12
263/19	180	40	290	12

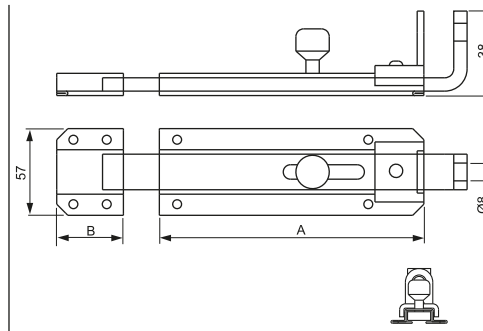

## Art. 264

## Catenaccio portalucchetto trasversale pesante



-  *Transverse heavy padlock bolt*
-  *Verrou transversal porte-cadenas lourd*
-  *Pestillo porta candado trasversal pesado*
-  *Massiver horizontaler Schlossriegel*

Materiale: Acciaio Zincato





Art.	A	B	Peso(g)	Conf.
264/15	130	65	590	8
264/20	230	65	830	8
264/30	300	100	1.060	6
264/40	400	100	1.300	6
264/50	500	100	1.520	6

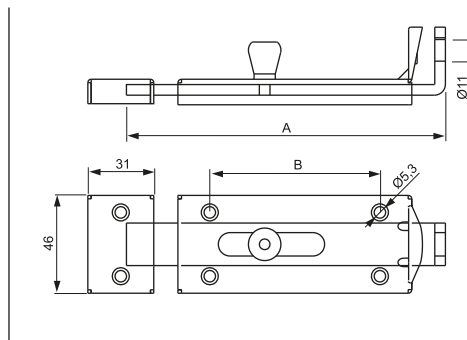

## Art. 252

## Catenaccio portalucchetto zincato



-  *Galvanized bolt for padlocks*
-  *Verrou porte cadenas zinguée*
-  *Pestillo porta cantado cincado*
-  *Vorhängeschloss Riegel aus verzinktem Stahl*





Materiale: Acciaio Zincato

Art.	A	B	Peso(g)	Conf.
252/1	150	77	270	12
252/2	200	117	330	12
252/3	250	157	390	12



Catenaccio verticale leggero ad avvitare zincato

Art. 256

-  Galvanized vertical light bolt to be screwed
-  Verrou vertical léger zingué à visser
-  Pasador vertiucal ligero cincado, a fijar con tornillos
-  Leichter Türkantriegel, vertikal aus verzinktem Stahl, zum Anschrauben

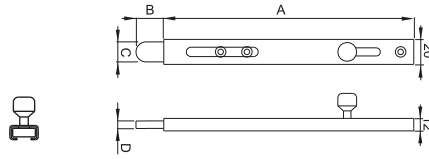





Materiale: Acciaio zincato

Art.	A	B	C	D	Peso(g)	Conf.	Imb.
256/20	200	30	16	6	170	20	
256/25	250	30	16	6	210	20	
256/30	300	50	16	6	240	20	
256/40	400	50	16	6	310	12	
256/50	500	50	16	6	390	12	
256/60	600	50	16	6	480	10	

Incontro ad avvitare per Art. 256

Art. 266

-  Steel meeting point to be screwed for Art. 256
-  Butée du bas à visser pour Art. 256
-  Encuentro a atornillar para art.256
-  Schliesskloben für Kantriegel Art. 256. Zum Anschrauben

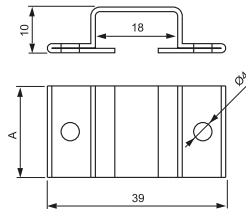





Materiale: Acciaio zincato

Art.	A	N.fori	Peso(g)	Conf.
266/1	20	2	10	50
266/2	40	4	20	50

Catenaccio verticale leggero a saldare zincato

Art. 257

-  Galvanized vertical light bolt to be welded
-  Verrou vertical léger zingué à souder
-  Pasador vertiucal ligero cincado, a soldar
-  Leichter Türkantriegel, vertikal, aus verzinktem Stahl, zum Schweißen

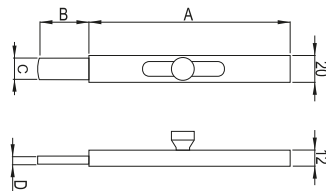





Materiale: Acciaio zincato

Art.	A	B	C	D	Peso(g)	Conf.
257/15	150	30	16	6	140	20
257/20	200	50	16	6	170	20
257/25	250	50	16	6	210	20
257/30	300	50	16	6	250	20
257/40	400	50	16	6	350	20
257/50	500	50	16	6	410	10
257/60	600	50	16	6	490	10
257/80	800	50	16	6	690	10

Incontro ad avvitare o a saldare per Art. 257

Art. 267

-  Steel meeting point to be screwed or welded for Art. 257
-  Butée du bas à visser ou à souder pour Art.257
-  Encuentro a atornillar o a soldar para Art. 257
-  Begegnung zum Schrauben oder Schweißen für Art.257

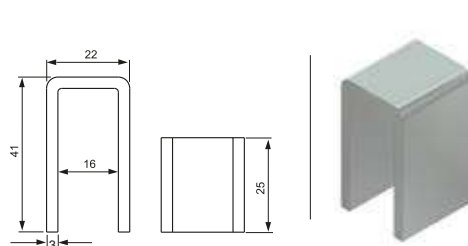

Art. 267/2

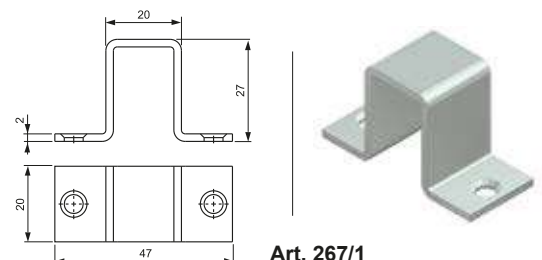

Art. 267/1

Materiale: Acciaio zincato

Art.	Peso(g)	Conf.
267/1	40	50
267/2	40	50

## Art. 261

## Catenaccio verticale tondo ad avvitare zincato portalucchetto

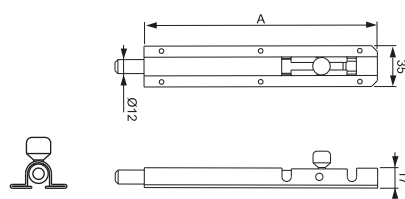

Materiale: Acciaio zincato

Art.	A	Peso(g)	Conf.
261/15	153	160	15
261/20	200	210	12
261/30	300	320	12
261/40	400	440	8
261/50	500	540	8
261/60	600	630	10
261/80	800	800	6

- Galvanized round vertical padlock bolt to be screwed
- Verrou porte-cadenas vertical rond zingué à visser
- Pestillo vertical redondo, con porta candado, zincado a fijar con tornillos
- Hangschlossriegel aus verzinktem Stahl mit abgerundeter Stange, zum Anschrauben

## Art. 268

## Incontro ad avvitare per Art. 261

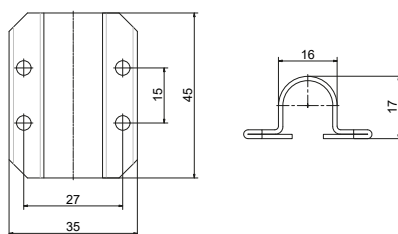

Materiale: Acciaio zincato

Art.	N.fori	Peso(g)	Conf.
268	4 Ø4	33	50

- Steel meeting point to be screwed for Art. 261
- Butée du bas à visser pour Art. 261
- Encuentro a atornillar para art.261
- Schliesskloben für Kantriegel Art. 261. Zum Anschrauben

## Art. 262

## Catenaccio verticale tondo a saldare zincato portalucchetto

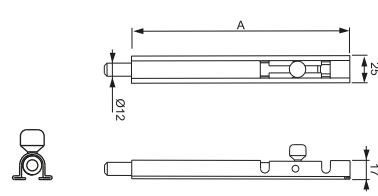

Materiale: Acciaio Zincato

Art.	A	Peso(g)	Conf.
262/15	150	160	12
262/20	200	210	12
262/30	300	320	12
262/40	400	440	10
262/50	500	540	10
262/60	600	630	10
262/80	800	800	10

- Galvanized round vertical padlock bolt to be welded
- Verrou porte-cadenas vertical rond zingué à souder
- Pestillo vertical redondo con porta cantado, zincado a soldar
- Hangschlossriegel aus verzinktem Stahl mit abgerundeter Stange, zum Schweißen

## Art. 269

## Incontro a saldare per Art. 262

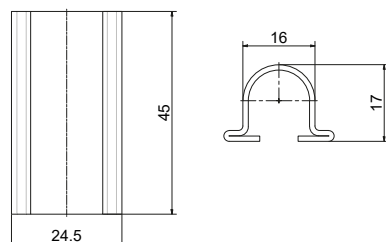

Materiale: Acciaio Zincato

Art.	Peso(g)	Conf.
269	26	50

- Steel meeting point to be welded for Art. 262
- Butée du bas à souder pour Art. 262
- Encuentro a soldar para art.262
- Schliesskloben für Kantriegel Art. 262. Zum Schweißen

## Copriangolo tondo in acciaio zincato

Art. 202

Galvanized steel round angular corner

Couvre-angulaire ronde en acier zingue

Cubre angular redondo en acero cincado

Knotenblech aus verzinktem Stahl

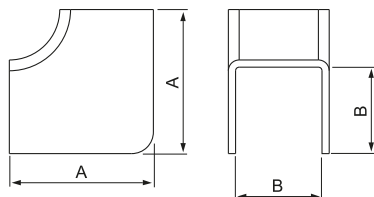

Materiale: Acciaio zincato

Art.	B X A	Peso(g)	Conf.
202/1	10X18	0,005	1.000
202/2	12X20	0,005	1.000

## Vite fermavetro

Art. 204

Self tapping screw for glass retaining strips

Vis pour bloquer les vitres

Tornillo autopenetrante para bloquear los vidrios

Schraube für Glasbefestigung

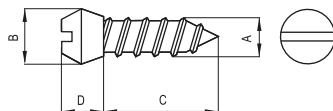

Art.	A	B	C	D	Peso(g)	Conf.
204/10	4,2	6,2	9,5	5,1	1,450	1.000
204/12	4,8	8	13	6	2,380	1.000

## Fermavetro in nylon

Art. 204/1

Nylon self tapping plug for glass retaining strips

Pièce nylon pour bloquer les vitres

Nylon para bloquear los vidrios

Befestigungsschrauben für Glas aus Nylon

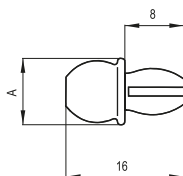

Materiale: Nylon nero



Art.	A	Peso(g)	Conf.
204/1.10	8	4	1.000
204/1.12	9	6	1.000

## Art. 198/1 - 1198

## Copri pilastro quadrato in acciaio ed acciaio inox da saldare

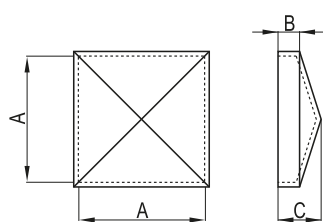

Materiale: Acciaio Grezzo / Acciaio Zincato / Acciaio Inox

Art.	A	B	C	Peso(g)	Conf.
198/1.2	20	7	13	15	50
198/1.3	30	7	14	25	50
198/1.4	40	7	16	36	50
198/1.5	50	7	17	48	100
198/1.6	60	7	20	72	100
198/1.8	80	7	23	110	70
198/1.10	100	8	28	170	30
198/1.12	120	8	30	240	25
198/1.15	150	8	37	360	15
198/1.17	175	12	37	570	20
198/1.20	200	15	40	720	20
1198/3	30	14	13	25	50
1198/4	40	16	15	36	50
1198/5	50	17	17	48	100
1198/8	80	23	20	110	70

● INOX  
 ● INOX  
 ● INOX  
 ● INOX

- Square steel and stainless steel pillar cover to be welded
- Couvre pilier carré en acier et en inox à souder
- Cubrepilares cuadrado en acero y en acero inox a soldar
- Pyramiden-Pfostenkappe, Vierkant aus Stahl oder Edelstahl, zum Schweißen

Per i copripilastrini zincati indicare dopo il codice la sigla ".76"  
 Es. 198/1.10.76

To order a galvanized pillar cover, add ".76" at the end of the code.  
 Ex.: 198/1.10.76

## Art. 198/2

## Copri pilastro rotondo in acciaio da saldare

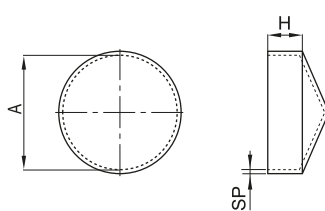

Materiale: Acciaio Grezzo / Acciaio Zincato

Art.	A	H	Sp	Peso(g)	Conf.
198/2.30	30	11	1,5	20	50
198/2.33	33	11	1,5	20	50
198/2.42	42	11	1,5	30	50
198/2.48	48	14	1,5	50	100
198/2.60	60,5	14,5	1,5	60	50
198/2.76	76	13	1,5	100	50
198/2.90	90	13	1,5	130	30
198/2.102	102	13	1,5	150	30
198/2.114	114	13	1,5	180	25

- Round steel pillar cover to be welded
- Couvre pilier rond en acier à souder
- Cubrepilares redondo en acero a soldar
- Runde Pfostenkappe aus Stahl oder Edelstahl, zum Schweißen

Per i copripilastrini zincati indicare dopo il codice la sigla ".76"  
 Es. 198/1.10.76

To order a galvanized pillar cover, add ".76" at the end of the code.  
 Ex.: 198/1.10.76

## Art. 198/3

## Copri pilastro sagomato



Importato

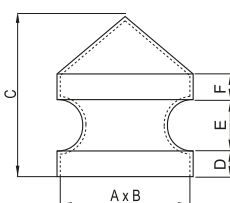

Materiale: Acciaio grezzo / Saldati e molati

Spessore 2mm

Art.	A	B	C	D	E	F	Peso(g)	Conf.
198/3.5	50	50	70	18	20	18	0,230	12
198/3.6	60	60	90	20	20	20	0,310	12
198/3.8	80	80	105	30	30	35	0,540	6
198/3.10	100	100	135	35	40	30	0,820	6
198/3.12	120	120	150	35	50	30	1,150	6
198/3.15	150	150	170	40	55	35	1,700	6
198/3.20	200	200	280	65	75	55	3,420	4

- Shaped cover pillar in steel, hot forged welded plate, with flashes
- Couvre pilier façonné en acier, avec ébarbages
- Cubrepilares sagomado de acero, placha estampada y soldada, con acabado de rebabaduras
- Geschmiedete Pyramiden-Pfostenkappe aus Stahl.

## Copritesta quadro per piloni

Art. 297

Square head cover

Couvre tête carré

Cubre cabeza cuadrado para pilar

Pfostenkappe aus Kunststoff, für Vierkantrohre.

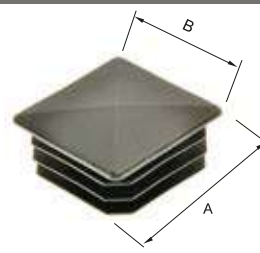
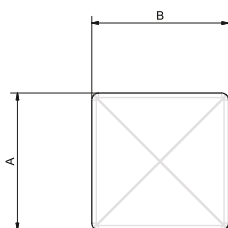

Materiale: Materiale plastico

Art.	Misure Ax B	Peso(g)	Conf.
297/16	16x16	1	200
297/20	20x20	2	200
297/25	25x25	4	100
297/30	30x30	5	100
297/35	35x35	7	100
297/40	40x40	11	50
297/50	50x50	12	50
297/60	60x60	18	50

## Copritesta tondo per piloni

Art. 298

Round head cover

Couvre tête rond

Cubre cabeza redondo para pilar

Pfostenkappe aus Kunststoff für Rundrohre

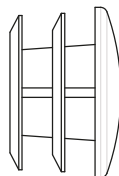
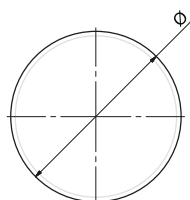

Materiale: Materiale plastico

Art.	Misure Ø	Peso(g)	Conf.
298/15	15	1	200
298/20	20	2	200
298/25	25	3	100
298/30	30	4	100
298/35	35	10	50
298/40	40	11	50
298/50	50	11	50
298/60	60	18	50
298/80	80	41	25
298/100	100	66	25

## Copritesta rettangolare per piloni

Art. 299

Rectangular head cover

Couvre tête rectangulaire

Cubre cabeza rectangular para pilar

Pfostenkappe aus Kunststoff für Rechteckige Rohre

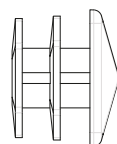
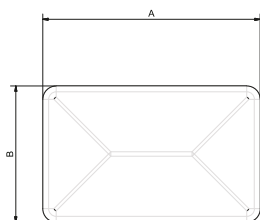

Materiale: Materiale plastico





Art.	Misure Ax B	Peso(g)	Conf.
299/15x30	15x30	2	200
299/20x30	20x30	3	100
299/20x40	20x40	4	100
299/25x40	25x40	6	100
299/25x50	25x50	8	100
299/30x40	30x40	8	100
299/30x50	30x50	12	50
299/30x60	30x60	12	50



## Art. 124

## Maniglione a due pieghe



-  Handle with two bends
-  Poignéé avec deux courbes
-  Manillón recto de acero barnizado negro
-  Zweifach gekröpfte Stoßgriffe

Materiale: Acciaio verniciato

Art.	A	B	C	D	E	F	Peso(g)	Conf.
124/20	240	200	117	30	70	47	430	6
124/25	290	250	167	30	70	47	515	6
124/30	340	300	215	30	70	47	600	6





**NOVAGUIDE**

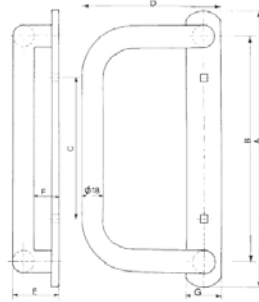

## Art. 125

## Maniglione a quattro pieghe



-  Handle with four bends
-  Poignéé avec quatre courbes
-  Manillón desplazado de acero barnizado negro
-  Vierfach gekröpfte Stoßgriffe

Materiale: Acciaio verniciato

Art.	A	B	C	D	E	F	G	Peso(g)	Conf.
125/20	240	200	117	118	45	25	30	450	6
125/25	290	250	167	118	45	25	30	530	6
125/30	340	300	215	118	45	25	30	610	6





**NOVAGUIDE**

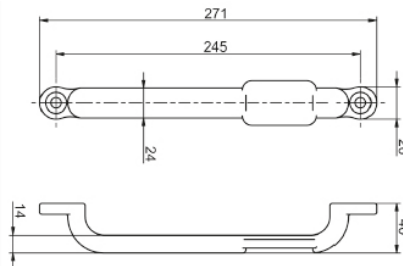

## Art. 3553

## Maniglione in alluminio con e senza logo



-  Aluminium handle with and without logo
-  Fermeture en aluminium avec et sans logo
-  Manillón en aluminio con o sin pegatina
-  Handgriffe aus Aluminium mit und ohne Aufkleber

Materiale: Alluminio verniciato





Art.	Var.	Peso(g)	Conf.
3553/1	con sticker	190	10
3553/2	senza sticker	180	10
3553/3	solo sticker	10	1.000

**NOVAGUIDE**



**Maniglia in lega verniciata nera con grano**

Art. 270

-  Black varnished alloy handle with grub screw
-  Poignée en alliage vernie en noir avec grain
-  Manija de aleación barnizada negra con prisionero
-  Schwarz-lackiertes Türdrückerpaar aus Legierung, mit Dübel

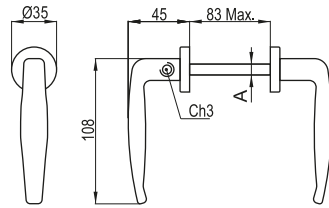

Importato  
Imported



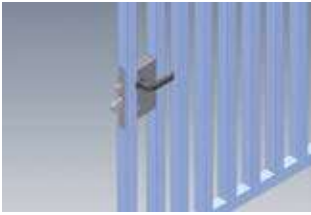

Materiale: Alluminio verniciato

Art.	A Ø	Peso(g)	Conf.
270/1	7	140	20
270/2	8	150	20



**Maniglia in lega verniciata nera con vite**

Art. 271

-  Black varnished alloy handle with screw
-  Poignée en alliage vernie en noir avec vis
-  Manija de aleación barnizada negra con tornillo
-  Schwarz-lackiertes Türdrückerpaar aus Legierung, mit Schraube

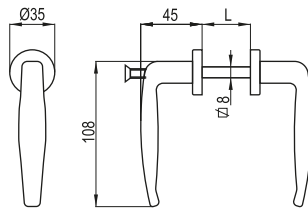

Importato  
Imported



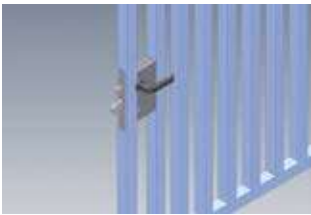

Materiale: Alluminio verniciato

Art.	L	Peso(g)	Conf.
271/1	25 - 35	120	20
271/2	35 - 45	130	20
271/3	40 - 50	130	20
271/4	50 - 60	140	20



**Kit braccio a quattro o sette scatti in ottone satinato**

Art. 280 - 281

-  Armed lever 4 or 7 clicks in satin brass
-  Brass avec 4 ou 7 déclics en laiton satiné
-  Brazo con 4 o 7 clicks de latón
-  Federschnapp-Verschluss Hebel aus satiniertem Messing (4 oder 7 Schnäpper)

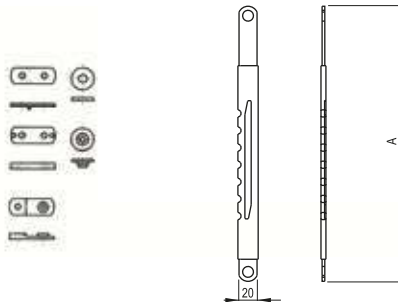

Completo di accessori  
per il fissaggio  
Complete with fixing  
accessories



Materiale: Ottone satinato

Art.	Apertura	Scatti	A	Peso(g)	Conf.
280/4	interno	4	190/260	140	12 SX - 12 DX
280/7	interno	7	250/370	190	12 SX - 12 DX
281/4	esterno	4	185/255	140	12 SX - 12 DX
281/7	esterno	7	270/390	200	12 SX - 12 DX



Various accessories for gates and other uses | Divers accessoires pour portails et autres usages | Varios accesorios para puertas y otros usos  
 Verschiedenes Zubehör für Tore und andere Anwendungen

# handy

Il modo più igienico di aprire!

ACCESSORIO PER MANIGLIE E MANIGLIONI  
 Per ridurre la trasmissione di virus e batteri.

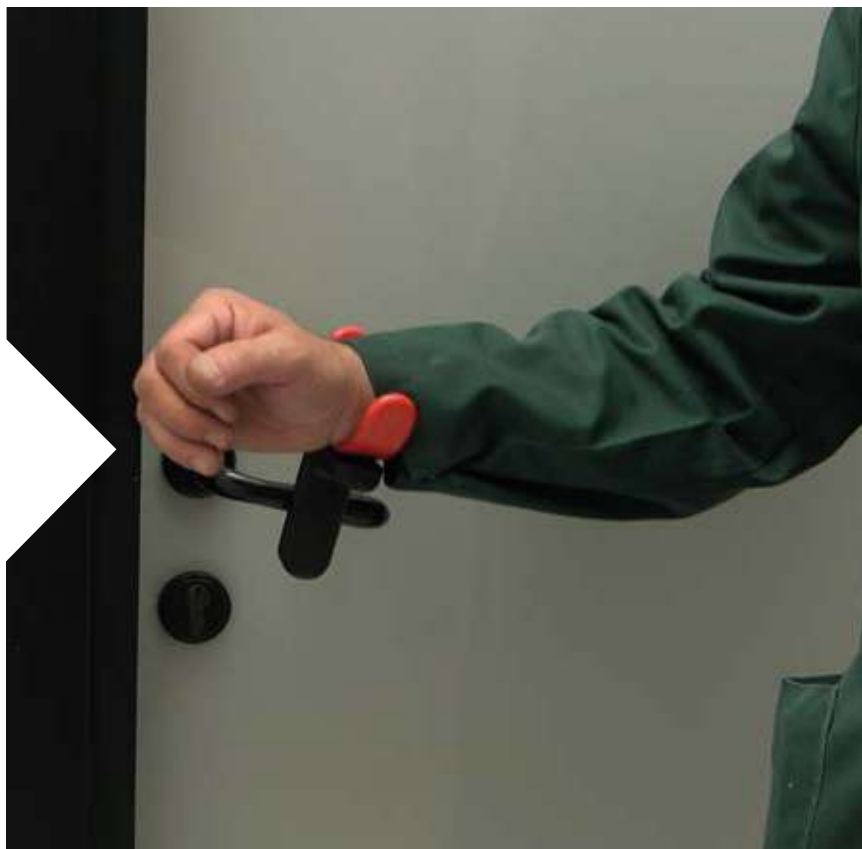

Per uso industriale

Per uso commerciale

Per uso civile



Art. 800R



Art. 800N

Guarda il video di HANDY  
 sul canale youtube di NovaFerr.

**You Tube**

[www.youtube.com/user/novaferr](http://www.youtube.com/user/novaferr)

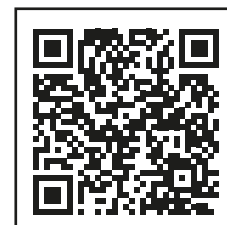

**HANDY è l'accessorio creato da NovaFerr che consente l'apertura di porte e portoncini senza dover toccare con le mani le maniglie o i maniglioni, riducendo la possibilità di trasmissione di virus e batteri.**

Fornito in kit, facile da installare e completamente regolabile si adatta facilmente a tutte le tipologie di maniglie di uso civile, commerciale ed industriale, sia su maniglie posizionate in orizzontale che in verticale.

Disponibile in due colorazioni che si abbinano alle differenti tipologie di maniglie o maniglioni garantendo la visibilità del dispositivo.

Accessorio per apertura a braccio Handy

Art. 800

🇬🇧 Handy arm-opening accessory

🇫🇷 Accessoire pour l'ouverture avec le bras Handy

🇪🇸 Accesorio de apertura con brazo Handy

🇩🇪 Zubehör zum Öffnen mit Handy-Arm

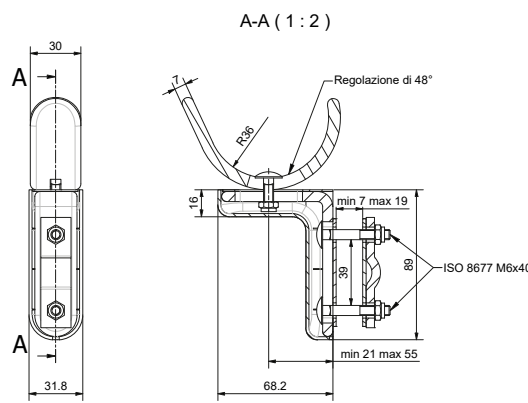

Materiale: Acciaio inox

Art.	Peso(g)	Conf.	lmb.
800R	310	1	10
800N	310	1	10

ISTRUZIONI DI MONTAGGIO

SU MANIGLIE / MANIGLIONI ORIZZONTALI

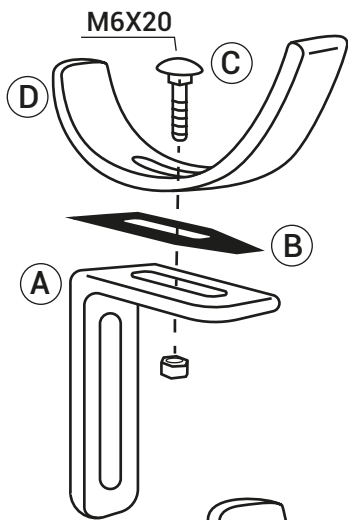

Fissare il supporto **D** sulla staffa **A** utilizzando il bullone **C**, frazionando tra **A** e **D** la piastrina **B**.

Assicurare Handy alla maniglia utilizzando la contropiastra **F** e le guarnizioni **G** fissandole con i bulloni **E**.

Terminate le regolazioni inserire la copertura **H**.

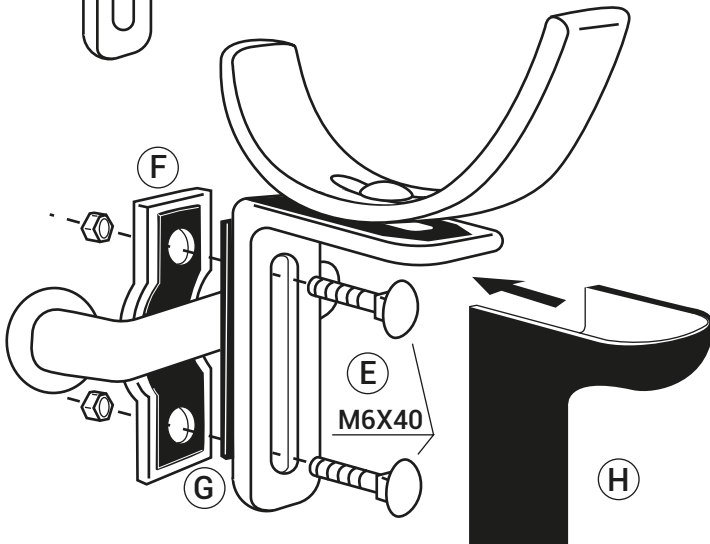

SU MANIGLIE / MANIGLIONI VERTICALI

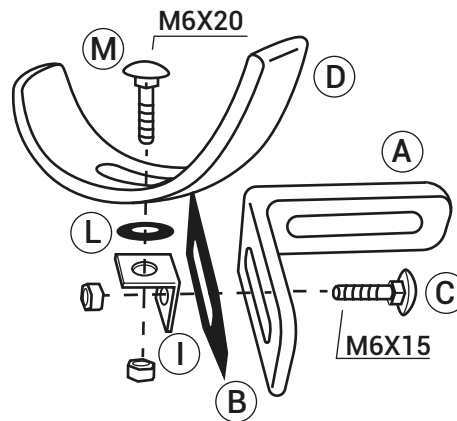

Fissare la piastrina **I** sulla staffa **A** utilizzando il bullone **C**, frazionando tra **A** e **I** la piastrina **B**.

Fissare il supporto **D** alla piastrina **I** utilizzando la rondella **L** e fissando il tutto con il bullone **M**.

Assicurare Handy alla maniglia utilizzando la contropiastra **F** e le guarnizioni **G** fissandole con i bulloni **E**.

Terminate le regolazioni inserire la copertura **H**.

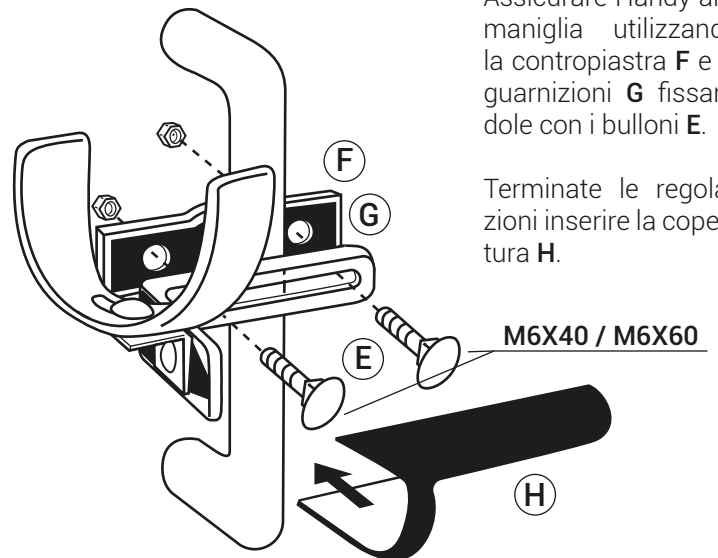

# NOVA-FERR srl

ACCESSORI PER SISTEMI SCORREVOLI  
SLIDING SYSTEM ACCESSORIES



Applicazione  
Supporto a soffitto (Art.29)

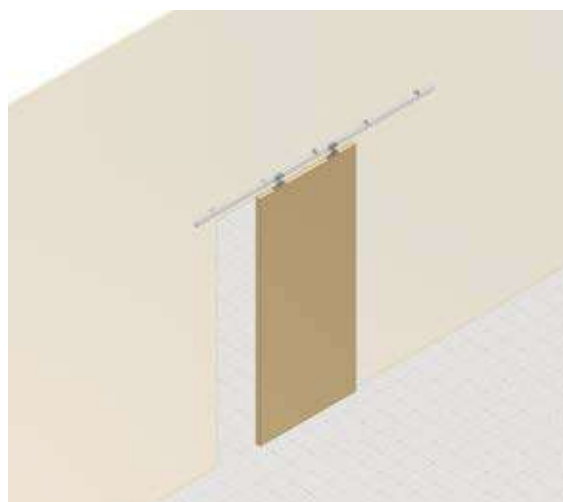
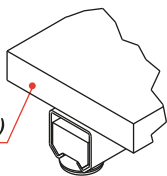

Applicazione porta interna

## Soluzione applicazione a soffitto

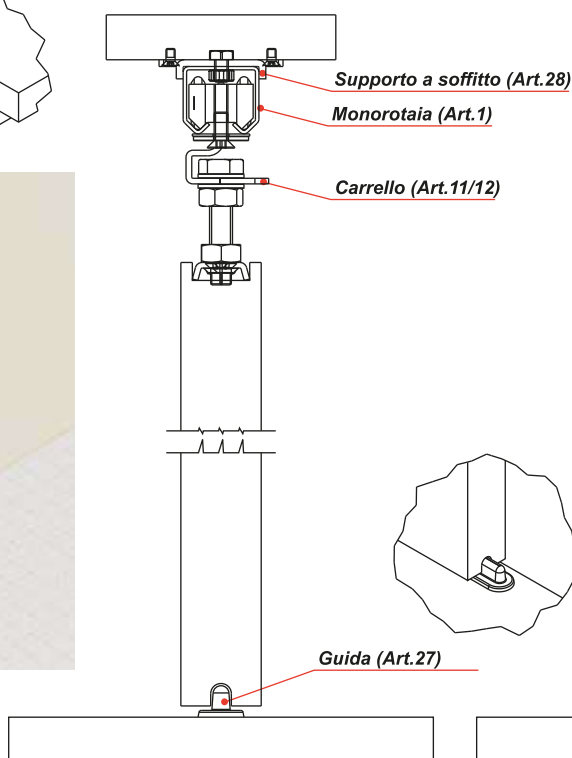

## Soluzione applicazione a parete

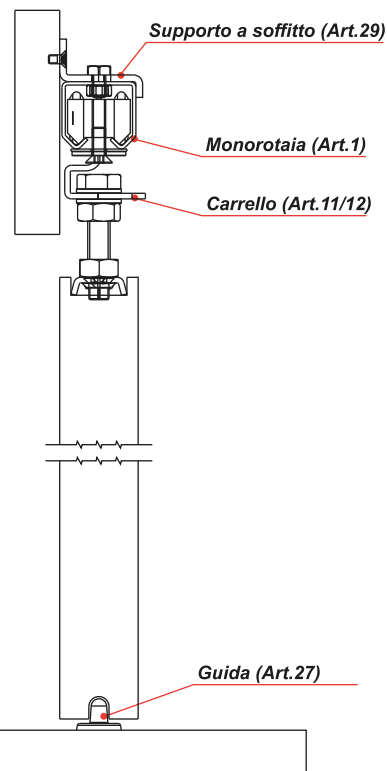

## Quote per un corretto posizionamento dei carrelli e delle staffe

Measures for a correct positioning of carriages and clamps

Dimensions pour un positionnement correct de chariots et plaques

Medidas para un correcto posicionamiento de carros y soportes

Abmessungen für den korrekten Betrieb von Wagen und Halterungen

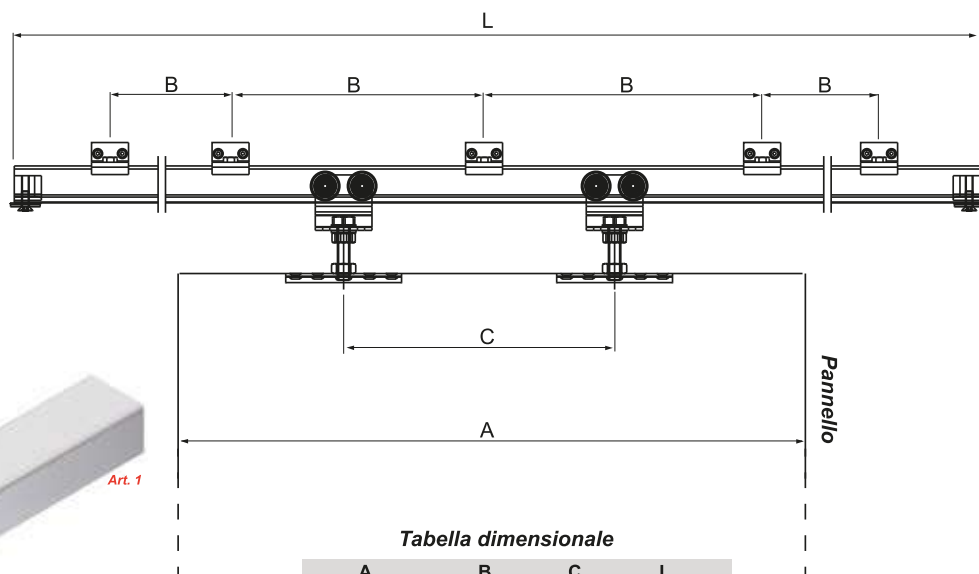

La guida per scorrevoli Art. 1 è asolata.

Asole guida Art. 1



Tabella dimensionale

A	B	C	L
500 - 700	500	250	1.100
710 - 900	500	450	1.500
910 - 1200	500	550	1.900
1210 - 1500	500	650	2.300
1510 - 1800	500	1.050	3.000

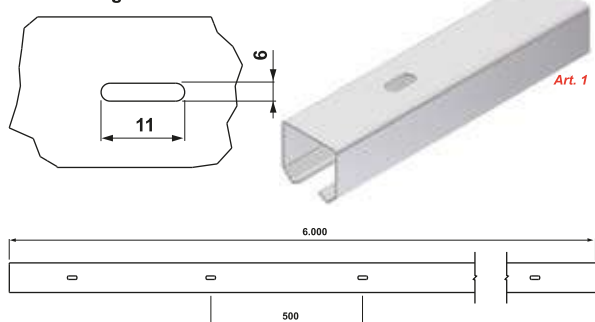
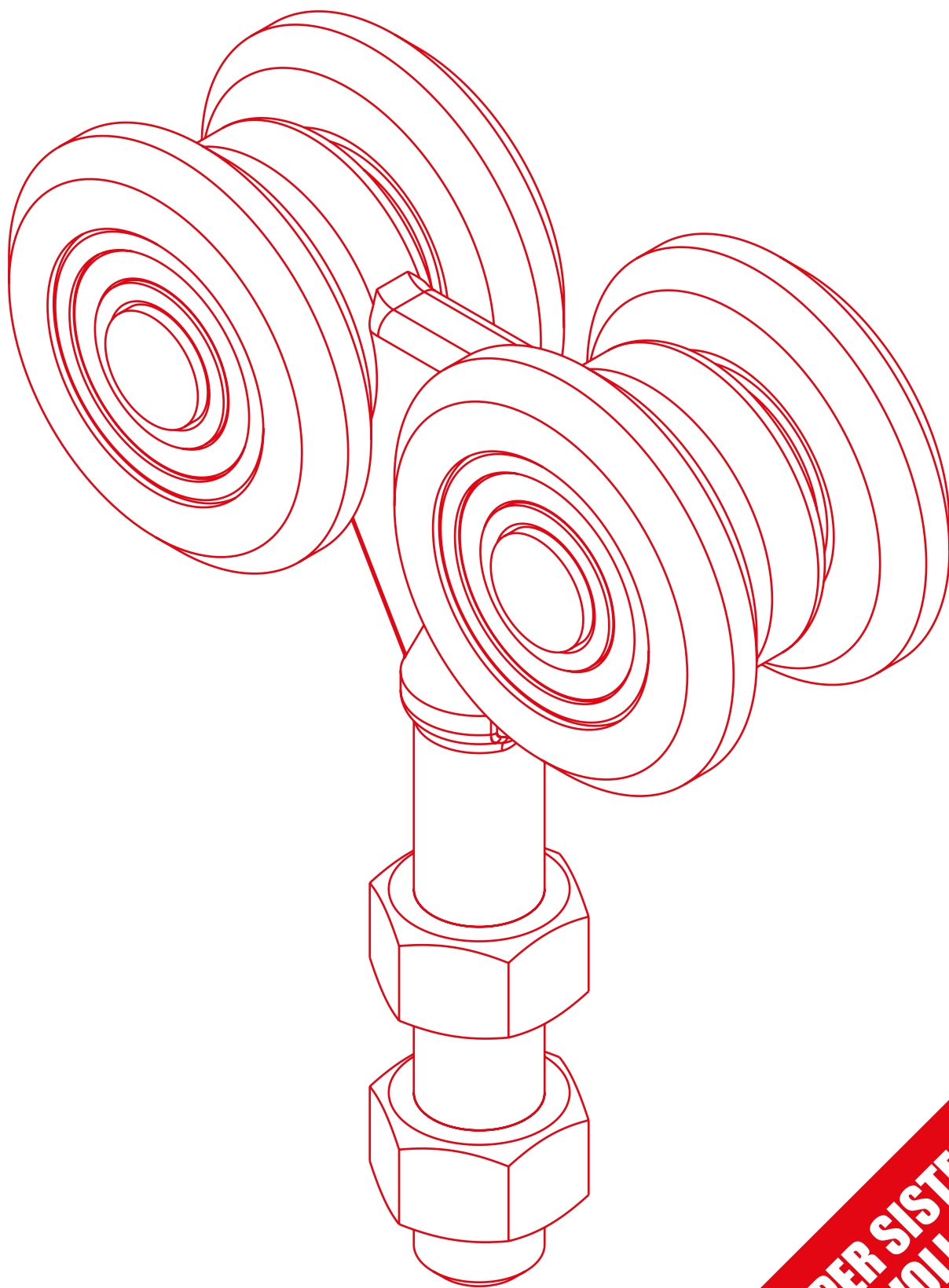

# ACCESSORI PER SISTEMI SCORREVOLI

Sliding system accessories  
Accessoires pour systèmes coulissants  
Accesorios para sistemas correderos  
Zubehör für Schiebessysteme

**CATALOGO  
N.25**

## Art. 11 Carrello Ø24 a 4 cuscinetti in acciaio zincato o nylon, completo di piastra e bullone 10MA

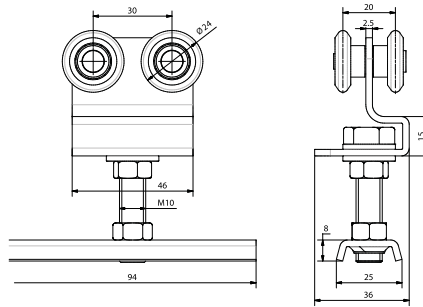

Materiale: Acciaio Zincato

Portata espressa in Kg.

Four wheel Ø24 ball bearings galvanized steel or nylon hanger with bracket and bolt 10MA

Chariot Ø24 en acier zingué ou nylon à 4 roulements avec support et boulon 10MA

Roldana Ø24 en acero cincado o nylon con 4 rodamientos con soporte y tornillo 10MA

Vierrädriger Rollapparat Ø24 aus verzinktem Stahl oder Nylon, mit Platte und Schraube 10MA

Art.	Var.	Peso(g)	Conf.
11.1	Acciaio	260	50
11.2	Nylon	230	50

## Art. 12 Carrello Ø24 a 2 cuscinetti in acciaio zincato o nylon, completo di piastra e bullone 8MA

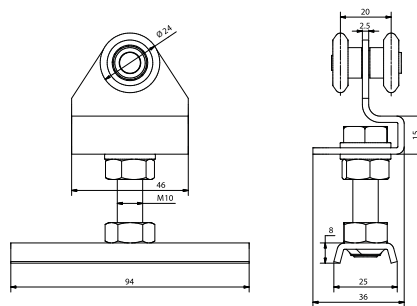

Materiale: Acciaio Zincato

Portata espressa in Kg.

Two wheel Ø24 ball bearings galvanized steel or nylon hanger with bracket and bolt 8MA

Chariot Ø24 en acier zingué ou nylon à 2 roulements avec support et boulon 8MA

Roldana Ø24 en acero cincado o nylon con 2 rodamientos con soporte y tornillo 8MA

Zweirädriger Rollapparat Ø24 aus verzinktem Stahl oder Nylon, mit Platte und Schraube 8MA

Art.	Var.	Peso(g)	Conf.
12.1	Acciaio	190	50
12.2	Nylon	175	50

## Art. 26 Fermo in nylon per monorotaia Art. 1

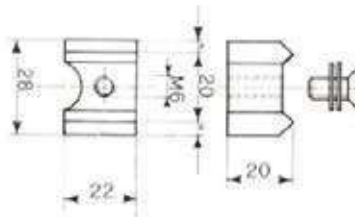

Materiale: Nylon

Nylon stop for track Art. 1

Arrêt en nylon pour rail Art. 1

Tope en nylon para guía Art. 1

Tor Endanschlag

Art.	Peso(g)	Conf.
26	15	50

## Art. 27 Guida inferiore in nylon per Art. 1

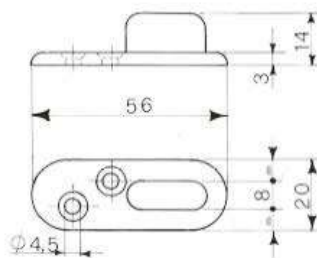

Materiale: Nylon

Bottom guide in nylon for Art. 1

Guide de bas en nylon pour Art. 1

Guía inferior en nylon para Art. 1

Untere Führungsschiene aus Nylon für Art. 1

Art.	Peso(g)	Conf.
27	5	50

Supporto a soffitto per monorotaia Art.1

Art. 28

🇬🇧 Ceiling bracket for track Art.1

🇫🇷 Support à plafond pour rail Art.1

🇪🇸 Soporte de techo para monoguía Art.1

🇩🇪 Decken-Befestigungsplatte für Laufschiene Art.1

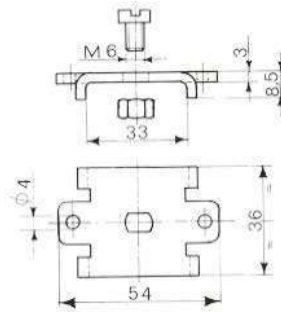

Materiale: Acciaio zincato

Art.	Peso(g)	Conf.
28	40	50

Supporto a parete per monorotaia Art.1

Art. 29

🇬🇧 Wall bracket for track Art.1

🇫🇷 Patte murale pour rail Art.1

🇪🇸 Soporte de pared para monoguía Art.1

🇩🇪 Wand-Befestigungsplatte für Laufschiene Art.1

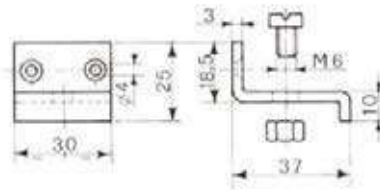

Materiale: Acciaio zincato

Art.	Peso(g)	Conf.
29	40	50

Kit di assemblaggio

Art. 18 - 19 - 20

🇬🇧 Assemblage - Kit

🇫🇷 Kit d'assemblage

🇪🇸 Kit de montaje

🇩🇪 Montage kit

Materiale: Acciaio zincato

Art. 18.1 / 18.2



Art. 18.1 / 18.2



Art. 18.1 / 18.2



Composizione Kit Art. 18.1

Art.	Pz.
12.1	2
26	2
27	1
28	2
29	2

Composizione Kit Art. 18.2

Art.	Pz.
12.2	2
26	2
27	1
28	2
29	2

Composizione Kit Art. 19.1

Art.	Pz.
11.1	2
26	2
27	1
28	2
29	2

Composizione Kit Art. 19.2

Art.	Pz.
11.2	2
26	2
27	1
28	2
29	2

Composizione Kit Art. 20.1

Art.	Pz.
13.1	2
26	2
27	1
28	2
29	2

Composizione Kit Art. 20.2

Art.	Pz.
13.2	2
26	2
27	1
28	2
29	2

Art.	Var.	Peso(g)	Conf.
18.1	Acciaio	570	8
18.2	Nylon	550	8
19.1	Acciaio	720	8
19.2	Nylon	650	8
20.1	Acciaio	500	8
20.2	Nylon	440	8



## Art. 1 - 50 - 75

## Monorotaia in acciaio zincato in barre da 6mt.

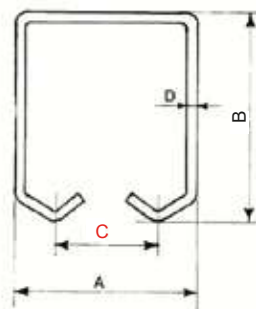

Galvanized steel track 6mt. lenght

Rail en acier zinguée 6mt. de longueur

Monoguía de acero cincado 6mt. larga

Einfachschiene für selbsttragende Tore

Materiale: Acciaio zincato

Art.	A	B	C	D	Asola	L	Peso(g)	Imb.
1	33	30	20	1,5	Si	6.000	1.250/mt	5
1.3	33	30	20	1,5	Si	3.000	1.250/mt	5
1.2	33	30	20	1,5	Si	2.000	1.250/mt	5
50	42	54	22	2,5	No	6.000	3.100/mt	3
75	57	67	30	3	No	6.000	4.750/mt	2

## Art. 10 - 51 - 76

## Carrello a 2 ruote in acciaio cementato e zincato o nylon

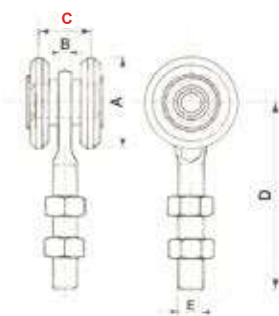

2 wheels cemented galvanized steel hanger

Chariot en acier zingué cementé à 2 galets

Carro en acero cincado cementado con 2 roldanas

2-KugellagerRollapparat, aus zementiertem und verzinktem Stahl

Materiale: Acciaio zincato

Art.	Var.	Sistema	A	B	C	D	E	Peso(g)	Conf.	Imb.
10.1	Acciaio	a sfere	24	4	20	50	M8	70	50	100
10.2	Nylon	a sfere	24	4	20	50	M8	55	50	100
51	Acciaio	a sfere/cementato	44	6	22	90	M12	310	25	25
76	Acciaio	a sfere/cementato	54	12	30	125	M20	850	20	20
51/C	Acciaio	a cuscinetto	44	6	22	90	M12	310	25	25
76/C	Acciaio	a cuscinetto	54	12	30	120	M20	850	20	20

## Art. 13/S - 52/S - 77/S

## Carrello a 4 ruote in acciaio cementato zincato

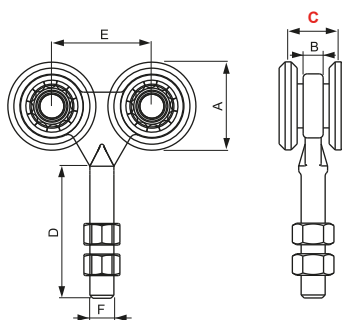

4 wheels cemented galvanized steel hanger

Chariot en acier zingué à 4 galets

Carro en acero cincado cementado con 4 roldanas

4-KugellagerRollapparat, aus zementiertem und verzinktem Stahl

Materiale: Acciaio zincato

Art.	Sistema	A	B	C	D	E	F	Peso(g)	Conf.
13.1/S	a sfere	24	4	20	32,5	30	M8	120	50
52/S	a sfere/cementato	44	8	22	64	48	M12	650	25
77/S	a sfere/cementato	54	12	30	82	60	M20	1.400	10

**Carrello a 4 ruote con cuscinetti Mod. 6001 ZZ** Art. 52/SC - 77/SC

- Wheels hanger with 4 ball bearings Mod. 6001 ZZ*
- Chariot à 4 galets avec roulements Mod. 6001 ZZ*
- Carro a 4 ruedas con rodaminetos Mod. 6001 ZZ*
- 4-Kugellager Rollapparat, Mod. 6001 ZZ*

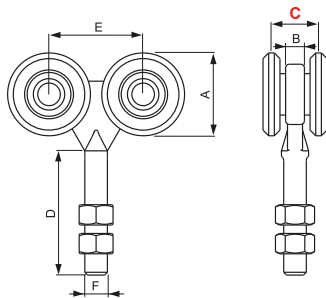

Materiale: Acciaio Zincato

Art.	Sistema	A	B	C	D	E	F	Peso(g)	Conf.
52/SC	a cuscinetto	44	8	22	64	48	M12	580	25
77/SC	a cuscinetto	54	11	30	85	60	M20	1.400	10

**Carrello a 4 ruote in acciaio cementato e zincato** Art. 13 - 52 - 77

- 4 wheels cemented galvanized steel hanger*
- Chariot en acier zingué cementé à 4 galets*
- Carro en acero cincado cementado con 4 ruedas*
- 4-Kugellager Rollapparat, aus zementiertem und verzinktem Stahl*

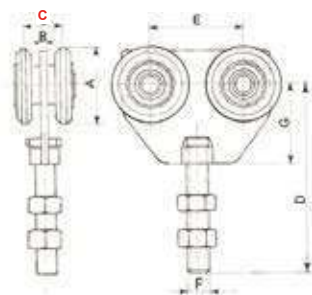

Materiale: Acciaio Zincato

Art.	Var.	Sistema	A	B	C	D	E	F	G	Peso(g)	Conf.
13.1	Acciaio	a sfere	24	4	20	68	30	M8	26	160	50
13.2	Nylon	a sfere	24	4	20	68	30	M8	26	130	50
52	Acciaio	a sfere/cementato	44	5	22	108	53	M12	44	650	25
77	Acciaio	a sfere/cementato	54	6	30	140	62	M20	61	1.400	10
52/C	Acciaio	a cuscinetto	44	5	22	108	53	M12	44	650	25
77/C	Acciaio	a cuscinetto	54	6	30	140	62	M20	61	1.400	10

**Carrello girevole a 4 ruote in acciaio cementato e zincato** Art. 54 - 79

- 4 wheels cemented galvanized steel swivel hanger*
- Chariot pivotant en acier zingué cementé à 4 galets*
- Carro giratorio con 4 ruedas en acero cincado cementado*
- Dreh-Rollapparat mit vier Kugellagern, aus zementiertem und verzinktem Stahl*

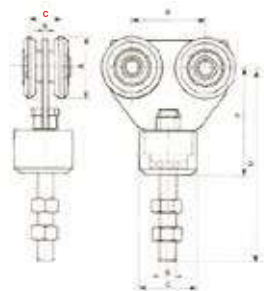

Materiale: Acciaio zincato

Art.	Sistema	A	B	C	D	E	F	G	H	Peso(g)	Conf.
54	a sfere/cementato	44	5	22	135	42	73	M12	53	910	10
79	a sfere/cementato	54	6	30	168	50	93	M18	62	1.850	6

**Carrello girevole a 2 ruote in acciaio cementato e zincato** Art. 78

- 2 wheels cemented galvanized swivel hanger*
- Chariots pivotant en acier zingué cementé à 2 galets*
- Carro giratorio con 2 ruedas en acero cincado cementado*
- Dreh-Rollapparat mit zwei Kugellagern aus zementiertem und verzinktem Stahl*

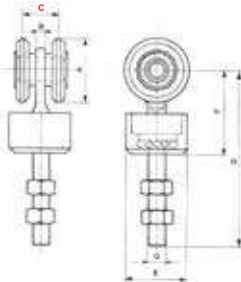

Materiale: Acciaio Zincato

Art.	Sistema	A	B	C	D	E	F	G	Peso(g)	Conf.
78	a sfere/cementato	54	12	30	145	50	75	M18	1.230	12

## Art. 92

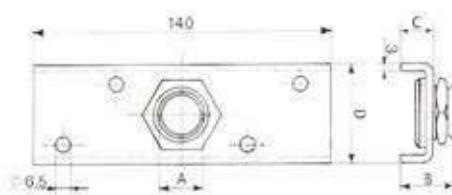

Materiale: Acciaio Zincato

Art.	A	B	C	D	Peso(g)	Conf.	Imb.
92/12	M12	20	11	31	160	30	30
92/16	M16	25	15	46	235	20	20
92/20	M20	25	15	46	250	20	20

## Staffa girevole di regolazione

Adjustable swivel bracket

Patte pivotante réglable

Placa giratoria regulable

Dreh-Befestigungsplatte

## Art. 56 - 81 Carrello a 4 ruote in acciaio cementato e zincato con cerniera a 3 ali, cuscinetti reggispinta

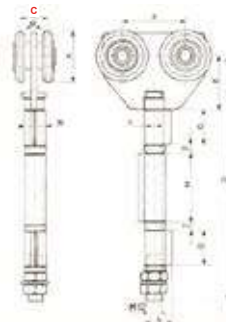

Materiale: Acciaio zincato

Art.	Sistema	A	B	C	D	E	F	G	H	I	L	M	Peso(g)	Conf.
56	a sfere/cementato	44	5	22	220	44	53	30	47	12	22	18	930	12
81	a sfere/cementato	54	6	30	235	61	62	39	60	14	28	20	1.670	6

Four wheel ball bearings cemented galvanized steel hanger with three wings hinge, with trust bearings

Chariots en acier zingué cimenté à 4 roulements avec paumelle à 3 ailes, avec paliers de butée

Roldana en acero cincado cementado con 4 rodamientos con bisagra a 3 alas, con rodamientos de empuje

Rollapparat mit vier Drucklagern und 3-Lasche Torband, aus zementiertem und verzinktem Stahl

## Art. 55 - 80 Carrello a 2 ruote in acciaio cementato e zincato con cerniera a 1 ala zincata

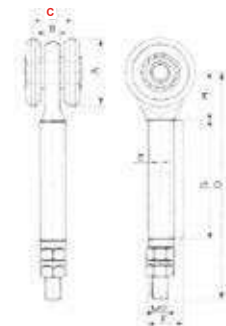

Materiale: Acciaio zincato

Art.	Sistema	A	B	C	D	E	F	G	H	Peso(g)	Conf.
55	a sfere/cementato	44	7	22	145	12	22	80	30	490	15
80	a sfere/cementato	54	11,5	30	180	14	28	95	42	910	8

Two wheel ball bearings cemented galvanized steel hanger with one wing hinge

Chariot en acier zingué cimenté à 2 roulements avec paumelle à 1 aile

Roldana en acero cincado cementado con 2 rodamientos con bisagra a 1 ala

Rollapparat mit zwei Kugellagern und mit 1-Lasche verzinktem Torband, aus verzinktem und zementierten Stahl oder Nylon

## Art. 57 - 82 Carrello terminale a 4 ruote in acciaio cementato e zincato con cerniera a 1 ala

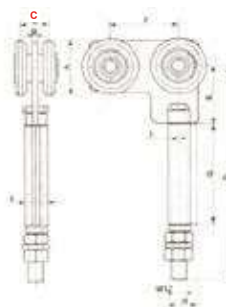

Materiale: Acciaio Zincato

Art.	Sistema	A	B	C	D	E	F	G	H	I	L	Peso(g)	Conf.
57	a sfere	44	5	22	165	44	53	80	22	12	18	790	10
82	a sfere	54	6	30	206	61	62	95	28	14	20	1.670	8

Four wheel ball bearings cemented galvanized steel end hanger with one wing hinge





Chariot final en acier zingué cimenté à 4 roulements avec paumelle à 1 aile

Roldana lateral en acero cincado cementado con 4 rodamientos con bisagra a 1 ala

Seitlicher 4-Kugellager Rollapparat mit 1-Lasche-Torband, aus zementiertem und verzinktem Stahl

Cerniera a tre ali per porte a libro

Art. 95

-  Three wings hinge for folding doors
-  Charnière à 3 ailes pour portes pliantes
-  Bisagra a 3 alas para puertas de libro
-  3-Lasche Torband für Falttüren

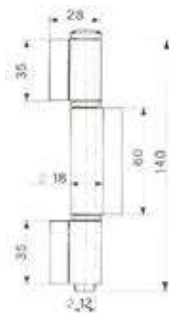





Materiale: Acciaio Zincato

Art.	Peso(g)	Conf.
95	318	20

Perno rullo inferiore con cerniera a tre ali per carrelli Ø44

Art. 96

-  Bottom pin brass roller with three wings hinge for Ø44 hangers
-  Pivot du bas rouleau en laiton avec paumelle à 3 ailes pour chariots Ø44
-  Pernio inferior con rodillo de latón con bisagra a 3 alas para roldana Ø44
-  Unteres Torband mit 3-Lasche für Rollapparat ø 44







Materiale: Acciaio zincato / Oliva Ottone

Art.	A	Peso(g)	Conf.
96/25	25	480	20
96/30	30	550	20

Perno rullo inferiore con cerniera a tre ali per carrelli Ø54

Art. 97

-  Bottom pin brass roller with three wings hinge for Ø54 hangers
-  Pivot du bas rouleau en laiton avec paumelle à 3 ailes pour chariots Ø54
-  Pernio inferior con rodillo de latón con bisagra a 3 alas para roldana Ø54
-  Unteres Torband mit 3-Lasche für Rollapparat ø 54

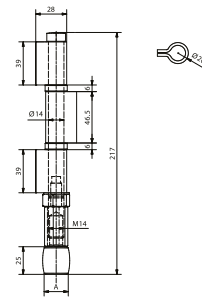





Materiale: Acciaio zincato / Oliva Ottone

Art.	A	Peso(g)	Conf.
97/25	25	580	20
97/30	30	660	20

Perno terminale rullo inferiore in ottone

Art. 98

-  Bottom end pin brass roller
-  Pivot du bas final rouleau en laiton
-  Pernio inferior lateral con rodillo de latón
-  Untere seitliche Führungsrolle aus Messing

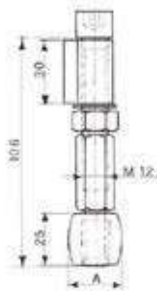

Materiale: Acciaio zincato / Oliva Ottone

Art.	A	Peso(g)	Conf.
98/25	25	260	35
98/30	30	330	35

## Art. 93

## Rullo guida in ottone con perno in acciaio zincato



Materiale: Acciaio zincato / Oliva Ottone

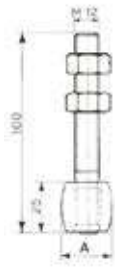

Brass roller with galvanized pin

Rouleau de guide en laiton avec pivot en acier zingué

Rodillo en latón con pernio de acero cincado

Bodenführungsrolle mit Platte aus verzinktem Stahl mit Rolle auf Messing

Art.	A	Peso(g)	Conf.
93/25	25	170	35
93/30	30	180	35

## Art. 94

## Deviatore con rullo in acciaio zincato e perno



Materiale: Acciaio Zincato

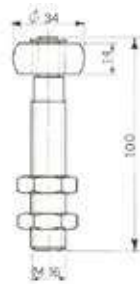

Galvanized steel deflector clamp with roller

Appareil de deviation en acier zingué avec rouleau

Desviador en acero cincado

Führungsrolle aus verzinktem Stahl mit Gewinde

Art.	Peso(g)	Conf.
94	230	35

## Art. 91

## Guida inferiore rullo in ottone



Materiale: Acciaio zincato / Oliva Ottone

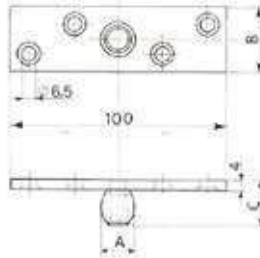

Bottom guide brass roller

Guide du bas - rouleau en laiton





Guia inferior con rodillo de latón

Untere Führungsplatte mit Führungsrolle aus Messing

Art.	A	B	C	Peso(g)	Conf.
91/15	15	30	20	170	35
91/25	25	40	30	180	25
91/30	30	40	30	180	25

**Art. 90**

**Blocco guida inferiore in acciaio forgiato**

-  *Forged steel bottom stop*
-  *Butée du bas en acier forgé*
-  *Encuentro para porton de libro*
-  *Bodenaufschuh aus Stahl*

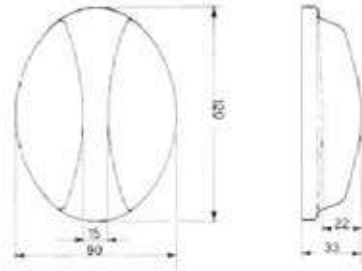





Materiale: Acciaio grezzo



Art.	Peso(g)	Conf.
<b>90</b>	1.340	12

**Art. 3977**

**Incontro a pavimento in alluminio**

-  *Aluminium floor meeting point for bar lock*
-  *Butée du bas en aluminium pour barre de fermeture*
-  *Encuentro en aluminio para el piso*
-  *Bodenaufschuh aus Aluminium*

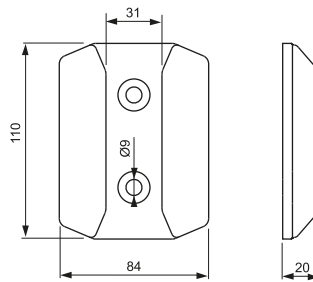





Materiale: Alluminio



Art.	Peso(g)	Conf.
<b>3977</b>	130	4

**Art. 3005**

**Incontro per portoni a libro**

-  *Steel meeting point for sliding doors*
-  *Butée du bas en acier zingué pour portes accordéon*
-  *Encuentro para porton a libro*
-  *Bodenaufschuh für Falttore*

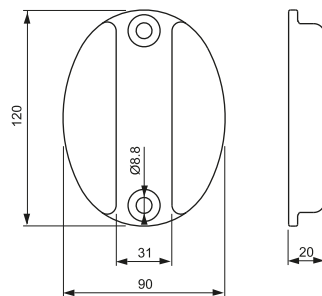

Materiale: Acciaio Zincato



Art.	Peso(g)	Conf.
<b>3005</b>	820	12

## Art. 2

## Carrello Ø24 a 1 cuscinetto in acciaio zincato o nylon

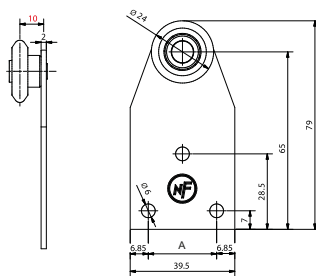

🇬🇧 One wheel Ø24 ball bearing galvanized steel or nylon hanger

🇫🇷 Chariot Ø24 en acier zingué ou nylon à 1 roulement

🇪🇸 Roldana Ø24 en acero cincado o nylon con 1 rodamiento

🇩🇪 Rollapparat Ø24 mit einem Kugellager, aus verzinktem Stahl oder Nylon

Materiale: Acciaio zincato

Art.	Var.	A	Portata(Kg)	Peso(g)	Conf.
2.1	Acciaio	25,8	15	60	250
2.2	Nylon	25,8	15	60	250

## Art. 5

## Carrello a 2 cuscinetti Ø24 in acciaio zincato o nylon

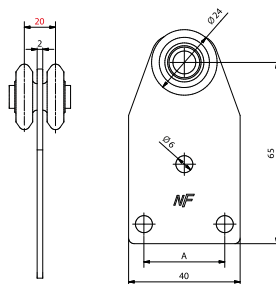

🇬🇧 Two wheel Ø24 ball bearings galvanized steel or nylon hanger

🇫🇷 Chariot Ø24 en acier zingué ou nylon à 2 roulements

🇪🇸 Roldana Ø24 en acero cincado o nylon con 2 rodamientos

🇩🇪 Zweirädriger Rollapparat Ø24 aus Stahl oder Nylon

Materiale: Acciaio Zincato

Art.	Var.	A	Portata(Kg)	Peso(g)	Conf.
5/1.1	Acciaio	29	30	80	150
5/1.2	Nylon	29	30	80	150
5/2.1	Acciaio	25,8	30	80	150
5/2.2	Nylon	25,8	30	80	150

## Art. 8

## Carrello 2 cuscinetti Ø24 in acciaio zincato o nylon, staffa piegata

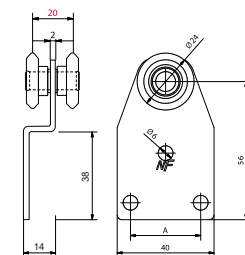

🇬🇧 Two wheel Ø24 ball bearings galvanized steel or nylon hanger with bended bracket

🇫🇷 Chariot Ø24 en acier zingué ou nylon à 2 roulements avec support tordu

🇪🇸 Roldana Ø24 en acero cincado o nylon con 2 rodamientos con soporte plegado

🇩🇪 Zweirädriger Rollapparat Ø24 aus Stahl oder Nylon mit gekröpften Befestigungsbügel

Materiale: Acciaio Zincato

Art.	Var.	A	Portata(Kg)	Peso(g)	Conf.
8/1.1	Acciaio	29	30	80	150
8/1.2	Nylon	29	30	80	150
8/2.1	Acciaio	25,8	30	80	150
8/2.2	Nylon	25,8	30	80	150

## Art. 25

## Contropiastra per art. 2, 5 e 8

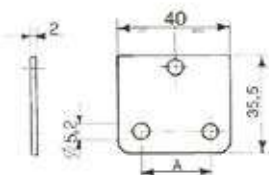

🇬🇧 Counter-plate for art. 2, 5 and 8

🇫🇷 Contreplatine for art. 2, 5 and 8

🇪🇸 Placa para art. 2, 5 y 8





🇩🇪 Gegenplatte für Artikel 2, 5 und 8

Materiale: Acciaio Zincato

Art.	A	Peso(g)	Conf.
25/1	29	20	150
25/2	25,8	20	150

Carrello a 2 cuscinetti Ø24 in acciaio zincato o nylon

Art. 3 - 6

-  Two wheel Ø24 ball bearings galvanized steel or nylon hanger
-  Chariot Ø24 en acier zingué ou nylon à 2 roulements
-  Roldana Ø24 en acero cincado o nylon con 2 rodamientos
-  Zweirädriger Ø24 Rollapparat aus verzinktem Stahl oder Nylon

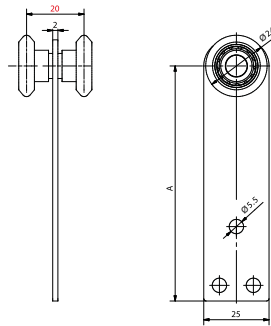





Materiale: Acciaio Zincato

Art.	Var.	A	Portata(Kg)	Peso(g)	Conf.
3.1	Acciaio	57	25	65	100
3.2	Nylon	57	25	65	100
6.1	Acciaio	90	25	80	100
6.2	Nylon	90	25	80	100

Carrello a 2 cuscinetti Ø24 in acciaio zincato o nylon, staffa piegata

Art. 9

-  Two wheel Ø24 ball bearings galvanized steel or nylon hanger with bended bracket
-  Chariot Ø24 en acier zingué ou nylon à 2 roulements avec support tordu
-  Roldana Ø24 en acero cincado o nylon con 2 rodamientos con soporte plegado
-  Zweirädriger Ø24 Rollapparat aus verzinktem Stahl oder Nylon mit gekröpftem Befestigungsbügel

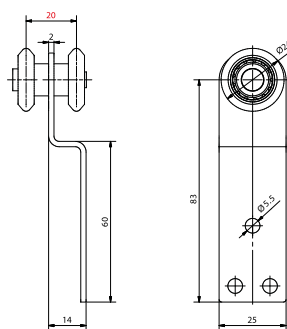

Materiale: Acciaio Zincato

Art.	Var.	Portata(Kg)	Peso(g)	Conf.
9.1	Acciaio	25	80	100
9.2	Nylon	25	80	100

Contropiastra per art. 3, 6 e 9

Art. 30

-  Counter - plate for art. 3, 6 and 9
-  Contreplatine pour art. 3, 6 et 9
-  Placa para art. 3, 6 y 9
-  Gegenplatte für Artikel 3.6.9

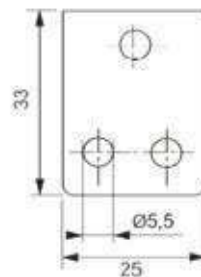

Materiale: Acciaio Zincato

Art.	Peso(g)	Conf.
30	20	150



## Art. 4

## Carrello 4 cuscinetti Ø24 in acciaio zincato o nylon



Materiale: Acciaio zincato

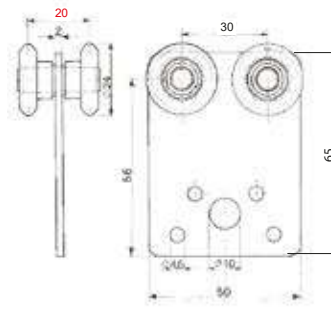

🇬🇧 Four wheels Ø24 ball bearings galvanized steel or nylon hanger

🇫🇷 Chariot Ø24 en acier zingué ou nylon à 4 roulements

🇪🇸 Roldana Ø24 en acero cincado o nylon con 4 rodamientos

🇩🇪 Vierrädrieger Rollapparat Ø24 aus verzinktem Stahl oder Nylon

Art.	Var.	Peso(g)	Conf.
4.1	Acciaio	125	100
4.2	Nylon	125	100

## Art. 7

## Carrello a 4 cuscinetti Ø24 in acciaio zincato o nylon, staffa piegata



Materiale: Acciaio zincato

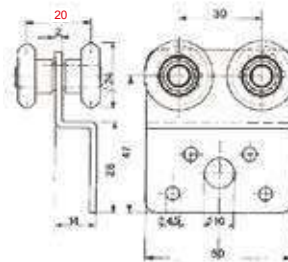

🇬🇧 Four wheels Ø24 ball bearings galvanized steel or nylon hanger

🇫🇷 Chariot Ø24 en acier zingué ou nylon à 4 roulements avec support tordu

🇪🇸 Roldana Ø24 en acero cincado o nylon con 4 rodamientos con soporte plegado

🇩🇪 Vierrädrieger Rollapparat Ø24 mit gekröpftem Befestigungsbügel aus verzinktem Stahl

Art.	Var.	Peso(g)	Conf.
7.1	Acciaio	125	100
7.2	Nylon	125	100

## Art. 24

## Contropiastra per art. 4 e 7



Materiale: Acciaio zincato

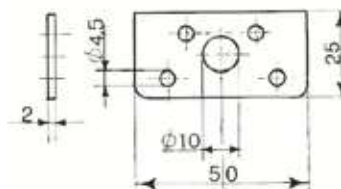

🇬🇧 Counter-plate for art. 4 and 7





🇫🇷 Contreplatine pour art. 4 et 7

🇪🇸 Placa para art. 4 y 7

🇩🇪 Gegenplatte für Artikel 4 und 7

Art.	Peso(g)	Conf.	lmb.
24	20	100	300

**Carrello Ø44 a 4 cuscinetti in acciaio cementato e zincato con asola** Art. 58



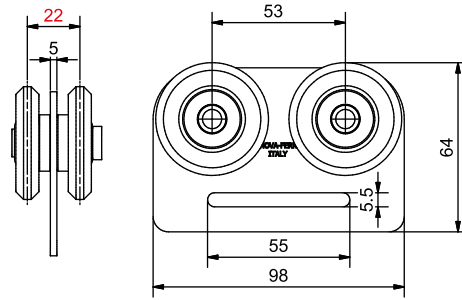

-  Four wheel Ø44 ball bearings cemente galvanized steel hanger with slot
-  Chariot Ø44 en acier cimenté et zingué à 4 roulements avec fente
-  Roldana Ø44 en acero cincado y cementado con 4 rodamientos con hendidura
-  Vierrädriger Rollapparat Ø44 aus verzinktem und zementiertem Stahl mit Langloch



Materiale: Acciaio zincato

Art.	Peso(g)	Conf.
58	620	25

**Carrello Ø36 a 2 cuscinetti in acciaio zincato** Art. 32



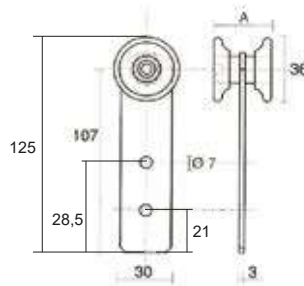

-  Two wheel Ø36 ball bearings galvanized hanger
-  Chariot Ø36 en acier zingué à 2 roulements
-  Roldana Ø36 en acero cincado con 2 rodamientos
-  Zweirädriger Rollapparat Ø 36 aus verzinktem Stahl



Materiale: Acciaio Zincato

Art.	A	Portata(Kg)	Peso(g)	Conf.
32/28	28	30	170	50
32/36	36	30	190	50

**Carrello Ø32 a 2 cuscinetti in acciaio zincato** Art. 31



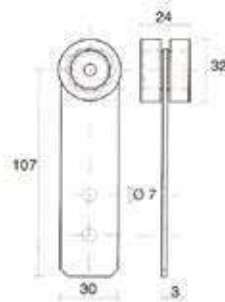

-  Two wheel Ø32 ball bearings galvanized hanger
-  Chariot Ø32 en acier zingué à 2 roulements
-  Roldana Ø32 en acero cincado con 2 rodamientos
-  Zweirädriger Rollapparat Ø 32 aus verzinktem Stahl



Materiale: Acciaio Zincato

Art.	Peso(g)	Conf.
31	170	50

**Morsetto in acciaio inox 304 con dadi autobloccanti filettati 6MA** Art. 459

-  Stainless steel 304 belt clamp with self blocking nuts thread 6MA
-  Etau pour sangles en acer inox 304 avec écrous autobloquants filet 6MA
-  Abrazadera para correas en acero inox 304 con dados bloqueantes filete 6MA
-  Klemme aus Edelstahl 304 mit selbstsperrenden Muttern

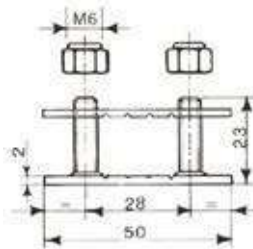

Materiale: Acciaio inox AISI304

Art.	Peso(g)	Conf.
459	50	200

# NOVA-FERR s.r.l

ACCESSORI PER PORTE BLINDATE  
ACCESSORIES FOR BLAST DOORS

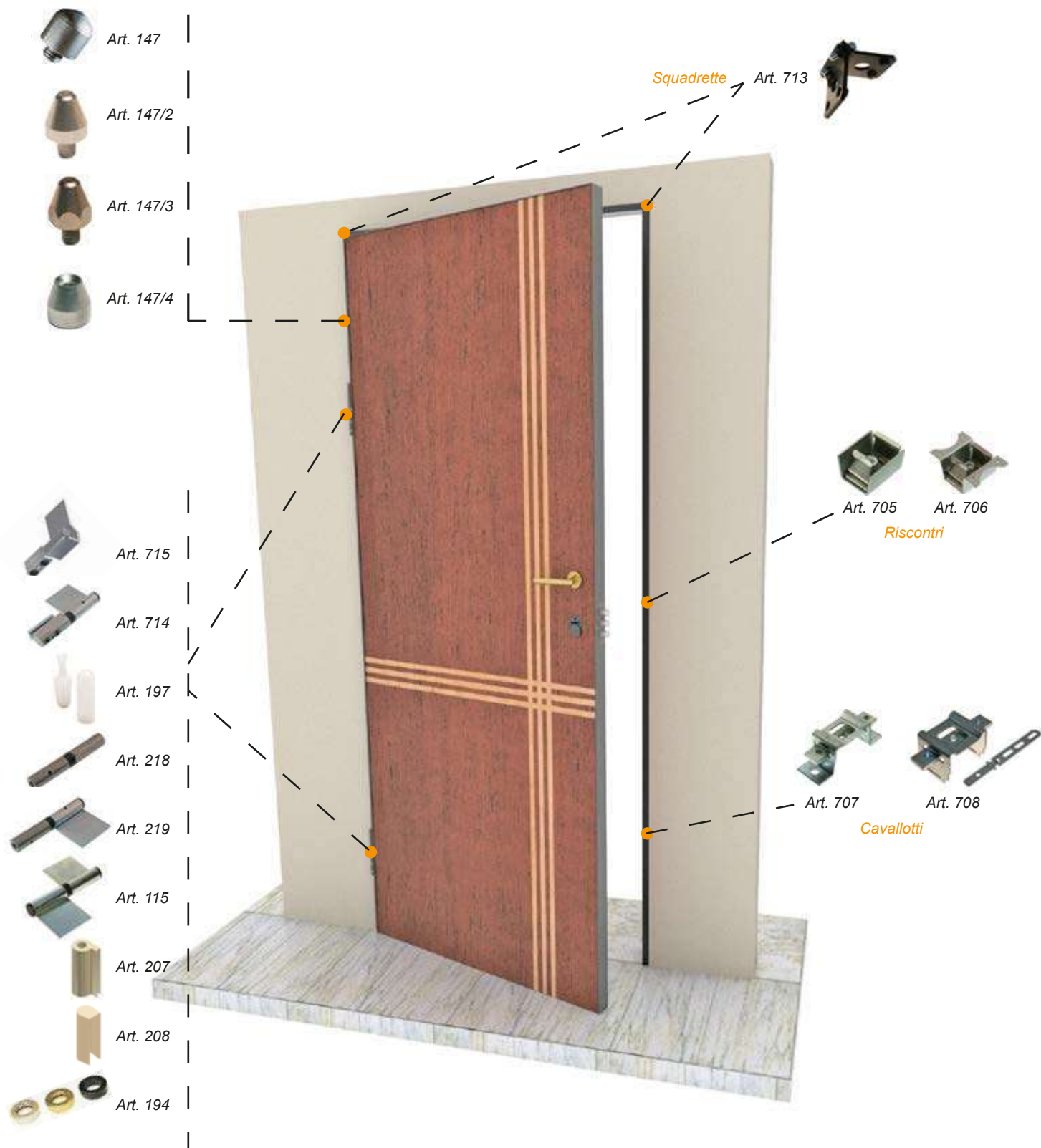

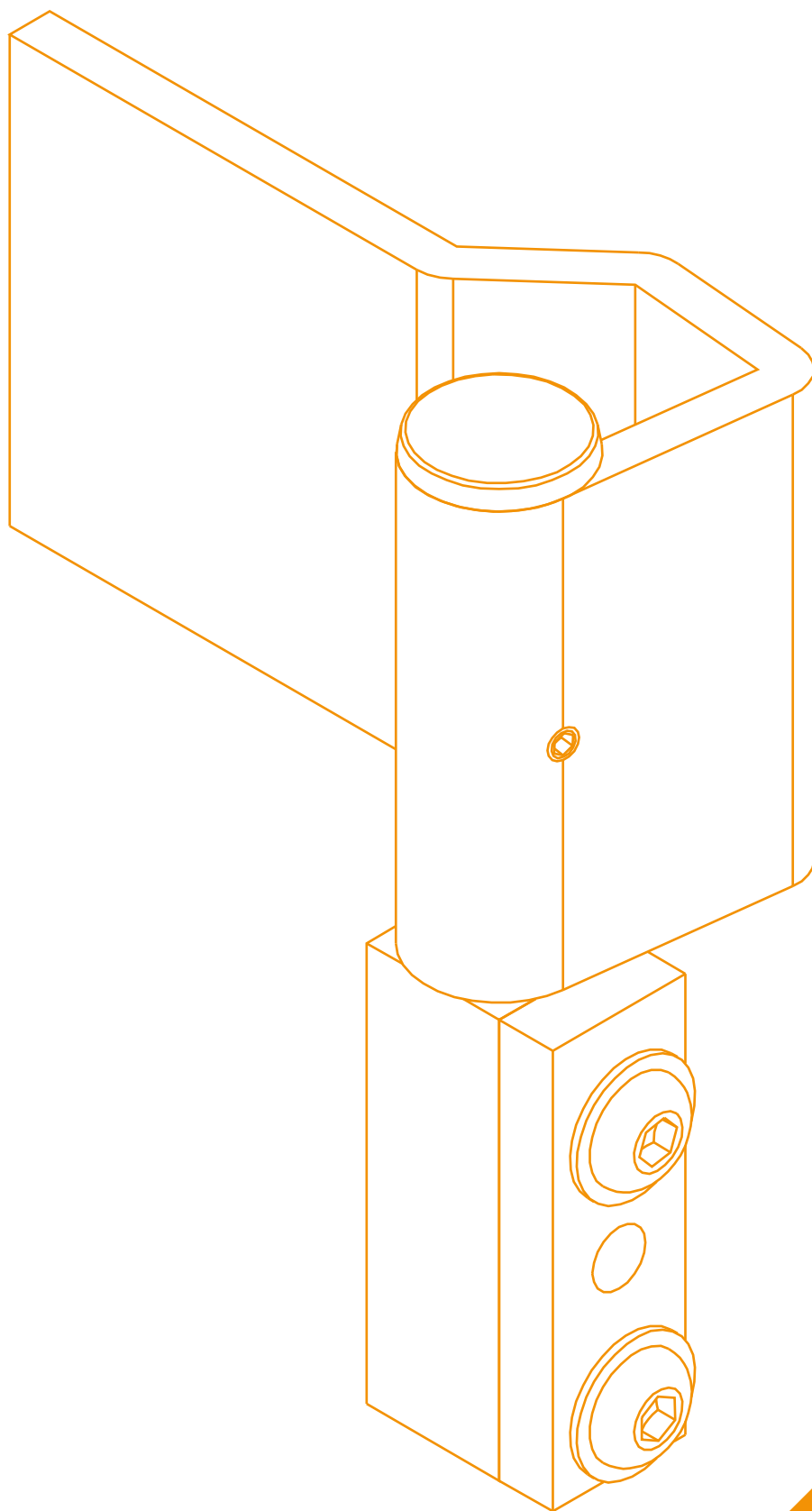

# ACCESSORI PER PORTE BLINDATE

Armoured doors accessories  
Accessoires pour portes blindées  
Accesorios para puertas blindadas - Аксессуары для  
Zubehör für gepanzerte Türen

**CATALOGO  
N.25**

**La certificazione sugli accessori  
Accessories certification**



CONSIGLIO NAZIONALE DELLE RICERCHE  
Istituto per le Tecnologie della Costruzione  
Sede di San Giuliano Milanese

**Apprecchiatura di prova  
in fase di chiusura**



NF Testing conformità UNI EN 1935:2004



Posizionamento cerniera  
parte superiore



Posizionamento cerniera  
parte inferiore

**Apprecchiatura di prova  
in fase di apertura**







NF Testing conformità UNI EN 1935:2004

Oltre ai test fisici effettuati, come convalida dell'integrità strutturale è stata utilizzata l'applicazione Analisi sollecitazione di Autodesk Inventor Professional.



Cerniera ambidestra a scomparsa

Art. 715

-  *Ambidextrous hidden hinge*
-  *Charnière ambidextre cachée*
-  *Bisagra ambidestra oculta*
-  *Beidhändig verstecktes Scharnier*

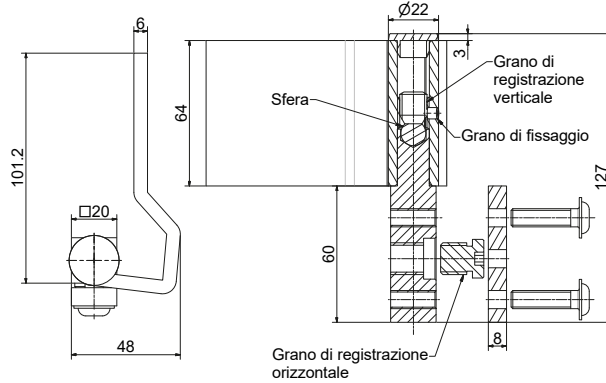
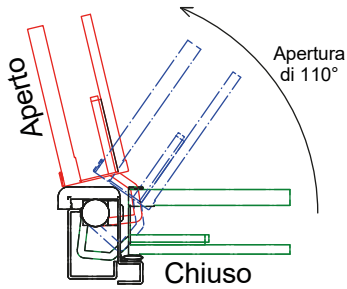

**Patented**





Materiale: Acciaio zincato

Art.  
Art.715

Peso(g)	Conf.
842	8

Cerniera ambidestra a scomparsa ala dritta

Art. 715/D

-  *Straight wing concealed ambidextrous hinge*
-  *Charnière ambidextre cachée à aile droite*
-  *Bisagra ambidestra oculta con ala recta*
-  *Gerader Flügel, verdecktes, beidhändiges Scharnier*

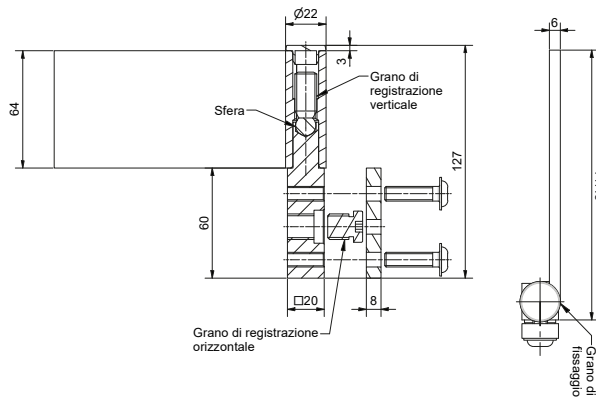
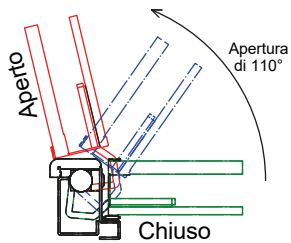

**Patented**

Materiale: Acciaio zincato

Art.  
Art.715/D

Peso(g)	Conf.
842	8

Caratteristiche generali

Registrazione in profondità



**Patented**

Grazie al dispositivo brevettato riusciamo a registrare fino a 4mm l'aletta fissata al montante

Registrazione in altezza

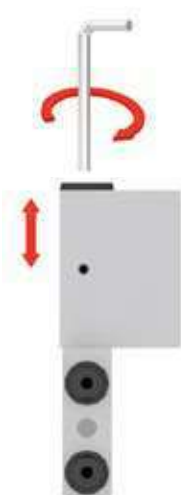

Lavorazioni su alette



Secondo le esigenze di ogni cliente, le cerniere vengono realizzate a disegno con la possibilità di effettuare qualsiasi lavorazione sulle alette in lamiera



Le alette in lamiera possono essere piegate a disegno in base ai vari telai utilizzati

Applicazione ambidestra

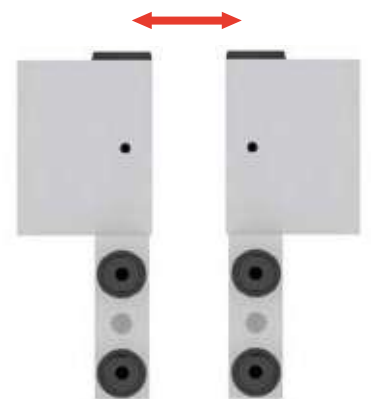

Girare l'ala in base alle esigenze, regolare il grano e fissarlo con grano più piccolo.

## Art. 714

## Cerniera ambidestra con doppia registrazione per porte blindate

Patented

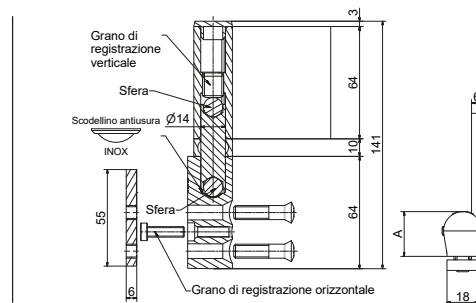

Adjustable "mushroom" hinge for armored doors

Charnière "champignon" réglable pour portes blindées

Bisagra ajustable de "hongo" para puertas blindadas

Verstellbares "Pilz"-Scharnier für gepanzerte Türen

Materiale: Acciaio zincato + alluminio

Art.	A	Peso(g)	Conf.
714/1	25,5	539	8
714/2	27,5	544	8
714/3	29,5	551	8

## Art. 178

## Cerniera destra e sinistra con doppia registrazione per porte blindate

Patented

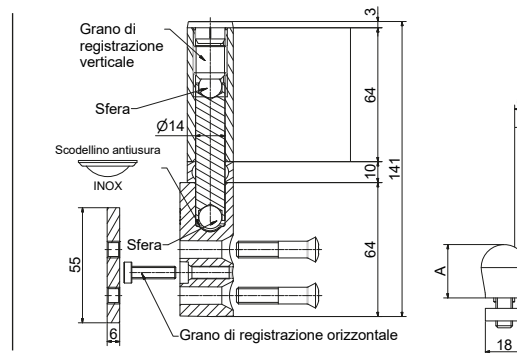

Hinge with double adjustment, balls pin in cemented steel, rubber spacer

Charnière à double réglage, avec pivot à sphères en acier cimenté, espaceur en caoutchouc

Charnela doble regulacion, con pernio a bolas de acero cementado, distanciador de goma

Rollenband mit Doppel Verstellung, Kugelstift und Gummiabstandhalter

Materiale: Acciaio zincato + alluminio

Art.	Var	A	Peso(g)	Conf.
178/1	Dx	25,5	539	8
178/2	Sx	25,5	539	8
178/3	Dx	27,5	544	8
178/4	Sx	27,5	544	8
178/5	Dx	29,5	551	8
178/6	Sx	29,5	551	8

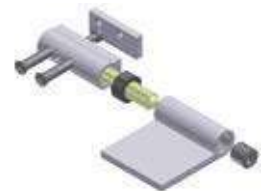

## Caratteristiche generali

### Registrazione in profondità

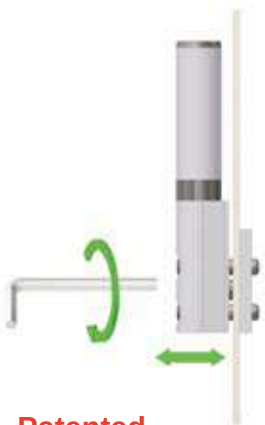

Patented

Grazie al dispositivo brevettato riusciamo a registrare fino a 4mm l'aletta in alluminio fissata al montante

### Registrazione in altezza

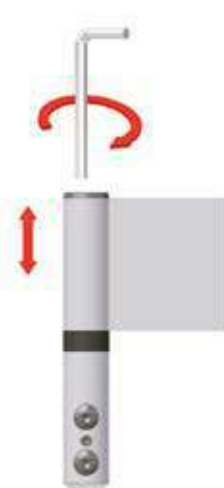

### Lavorazioni su alette



Secondo le esigenze di ogni cliente, le cerniere vengono realizzate a disegno con la possibilità di effettuare qualsiasi lavorazione sulle alette in lamiera







Le alette in lamiera possono essere piegate a disegno in base ai vari telai utilizzati



In caso di cerniera ambidestra girare l'ala in base alle esigenze, regolare il grano e fissarlo con grano più piccolo.

Coprialta superiore in materiale plastico

Art. 207

-  Plastic upper wing cover
-  Couvercle supérieur de l'aile en plastique
-  Cubierta superior del ala de plástico
-  Obere Flügelabdeckung aus Kunststoff

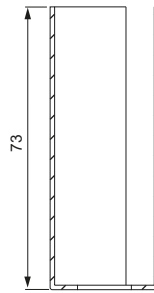
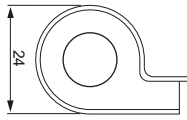





Materiale: Polipropilene

Art.	Colore	Lato	Peso(g)	Conf.
207/1.7	Marrone	DX	4	50
207/1.1	Nero	DX	4	50
207/2.7	Marrone	SX	4	50
207/2.1	Nero	SX	4	50

Coprialta inferiore in materiale plastico

Art. 208

-  Plastic lower wing cover
-  Couvercle inférieur de l'aile en plastique
-  Cubierta inferior del ala de plástico
-  Untere Flügelabdeckung aus Kunststoff

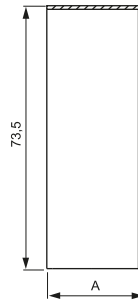
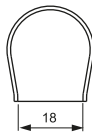

Materiale: Polipropilene

Art.	A	Colore	Peso(g)	Conf.
208/1.7	25,5	Marrone	5	50
208/2.7	27,5	Marrone	5	50
208/3.7	29,5	Marrone	5	50
208/1.1	25,5	Nero	5	50
208/2.1	27,5	Nero	5	50
208/3.1	29,5	Nero	5	50



## Art. 705

## Riscontro per scrocco a saldare con antischeda

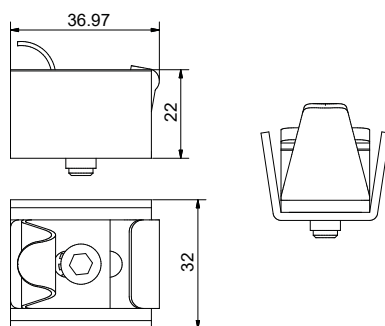

Strike plate for latch bolt with anti-card system to be welded

Butée à souder avec demi-tour

Tope de resbalón con anti-bump para soldar

Auflaufschuh für Verriegelung mit Antiblockiersystem zu Schweißen

Materiale: Acciaio zincato

Art.	Peso(g)	Conf.
705	70	25

## Art. 706

## Riscontro per scrocco ad avvitare con antischeda

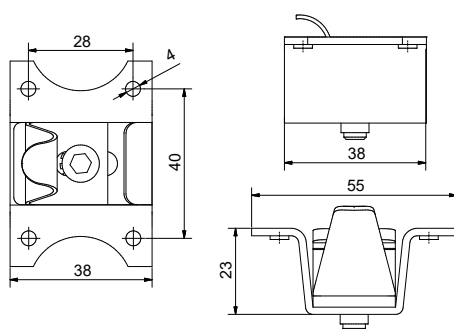

Strike plate for latch bolt burglar-proof, to be screwed

Butée à visser avec demi-tour

Tope de resbalón con anti-bump para atornillar

Auflaufschuh für Falle mit Sicherheitssystem zu schrauben

Materiale: Acciaio zincato

Art.	Peso(g)	Conf.
706	80	25

## Art. 707

## Cavallotto ad avvitare con piastrina

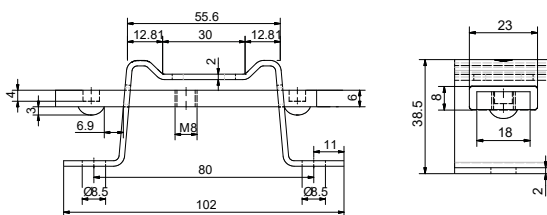

Galvanized steel bracket for counter frame screw-fixing with plate

Etrier de fixation pour contre-châssis en acier zingué avec platine, à visser

Estribo de suspensión en acero cincado para fijar al contramarco, para atornillar





Ü-Bügel mit Platte zur Befestigung an Gegenrahmen zum Schrauben

Materiale: Acciaio zincato

Art.	Peso(g)	Conf.
707	140	50

Cavallotto con piastrina e zanca a murare

Art. 708

-  Galvanized bent bracket for counter frame mounting, to wall up
-  Plaque de fixation du châssis en acier zingué, pour être cimenté au mur
-  Placa en acero cincado para contramarco con plaqueta, para soldar
-  Ü-Bügel mit Platte zum Schweißen an Gegenrahmen, zum Schweißen

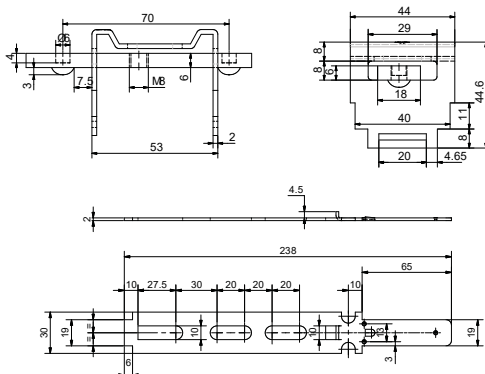

Materiale: Acciaio zincato

Art.	Peso(g)	Conf.
708	230	50

Squadretta per telaio

Art. 713

-  Brackets
-  Équerres
-  Soportes
-  Befestigungswinkel

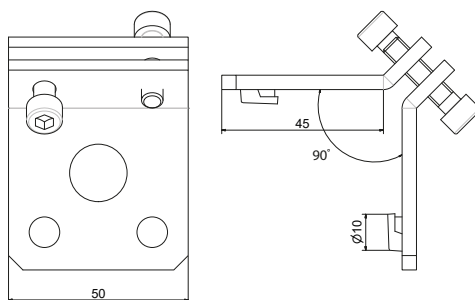

Art.	Colore	Peso(g)	Conf.
713/1	Nero	180	12
713/2	Bianco	180	12

## Art. 219

## Cerniera regolabile tornita con ala in lamiera

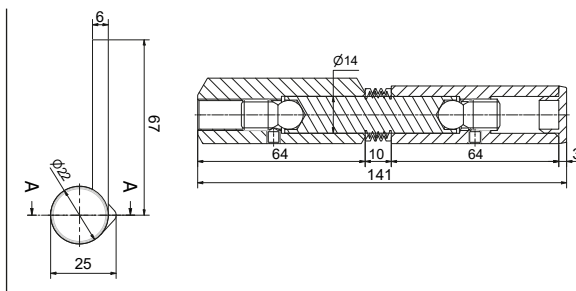

Materiale: Acciaio zincato

- Adjustable turned hinge with sheet metal wing
- Charnière ajustable avec ailette en tôle
- Bisagra torneada ajustable con ala de chapa
- Verstellbares gedrehtes Scharnier mit Blechflügel

Art.	Perno	Peso(g)	Conf.
219		520	8

## Art. 115

## Cerniera a doppia registrazione ambidestra perno a sfere distanziale in gomma

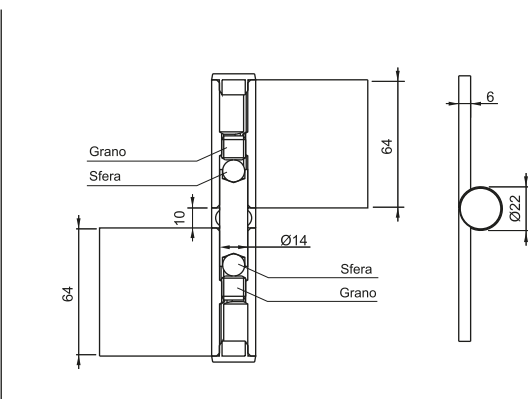

Materiale: Acciaio zincato

- Hinge with double adjustment, balls pin in cemented steel, rubber spacer
- Charnière à double réglage, avec pivot à sphères en acier cimenté, espaceur en caoutchouc
- Charnela doble regulación, con pernio a bolas de acero cementado, distanciador de goma
- Anschweißband mit Dualverriegelung, Kugelstift und Zwischenstück aus Gummi

Art.	Peso(g)	Conf.
115	555	8

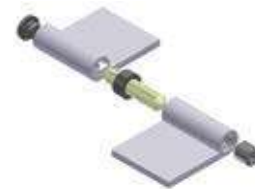

## Art. 214

## Cerniera ambidestra con rondella e perno sfilabile

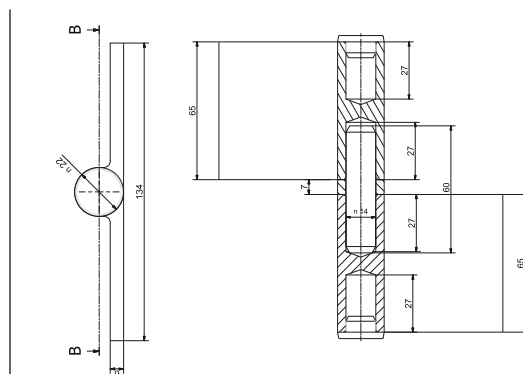
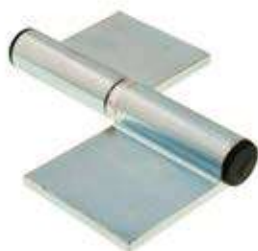

Materiale: Acciaio trafilato





- Ambidextro hinge with washer and removable pin
- Charnière ambidextre avec rondelle et pivot extractible
- Bisagra ambidextra con arendela y pernio extraíble
- Formgepresstes verstellbares 3-teiliges Anschweißband mit Edelstahl-Stift und Befestigungsdübel.

Art.	perno	rond.	finitura	Peso(g)	Conf.
214.3.5	ottone	ottone	grezza	710	8
214.2.5	ferro zinc	ferro zinc	grezza	710	8
214.2.4	ferro zinc	cuscinetto	grezza	710	8
214.3.5.76	ottone	ottone	zincata	710	8
214.2.5.76	ferro zinc	ferro zinc	zincata	710	8
214.2.4.76	ferro zinc	cuscinetto	zincata	710	8



Cerniera regolabile stampata

Art. 223

-  *Pressed adjustable hinge*
-  *Charnière réglable à moulage*
-  *Bisagra ajustable impresa*
-  *Gepresstes verstellbares Scharnier*

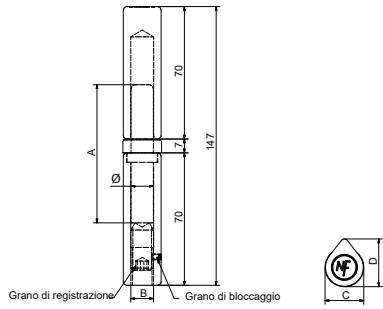





STAMPATA  
PRESSED



Art.	A	B	C	D	Ø	Peso(g)	Conf.
223/1	73	M12	20	25	12	370	20
223/2	77	M12	22	25	14	420	15

Cerniera regolabile tornita c/profilo a goccia

Art. 216

-  *Adjustable turned hinge with pin*
-  *Paumelle réglable façonnée au tour avec pivot*
-  *Charnela torneada perfilada a gota con pernio*
-  *Einstellbares Tropfen-Anschweißband*

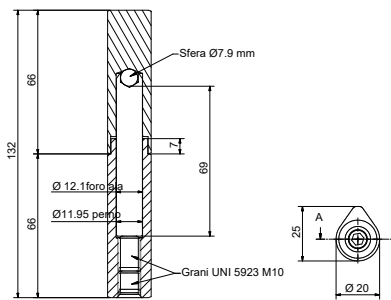





Materiale: Acciaio grezzo

Art.	Peso(g)	Conf.
216	340	20

Cerniera regolabile tornita 22x25

Art. 218



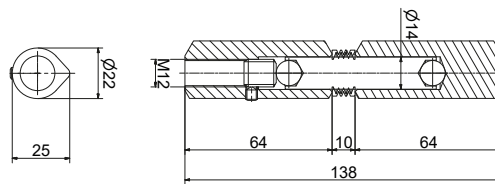

-  *Adjustable turned hinge 22X25*
-  *Charnière ajustable 22X25*
-  *Bisagra torneada ajustable 22X25*
-  *Verstellbares gedrehtes Scharnier mit Blechflügel*



Art.	Peso(g)	Conf.
218	360	15

Cerniera tornita a goccia con gommino, perno inox con sfera registrabile

Art. 129

-  *Turned profile parisienne hinge with rubber spacer, stainless steel pin with ball*
-  *Charnière façonnée au tour profil en goutte, entretoise en gomme, pivot inox avec bille*
-  *Charnela regulable torneada a perfil gota con goma distanciadora, eje en inox con esfera*
-  *Formgepresstes einstellbares Tropfen-Anschweißband mit Messingstift.*

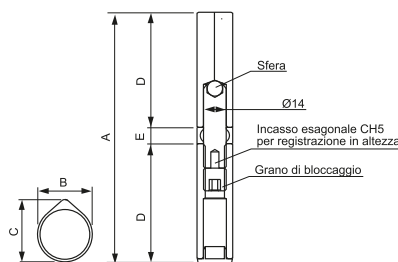





Materiale: Acciaio grezzo Perno: Inox

Art.	A	B	C	D	E	Peso(g)	Conf.
129/1	105	22	25	48	10	280	20
129/2	155	22	25	71	10	380	20

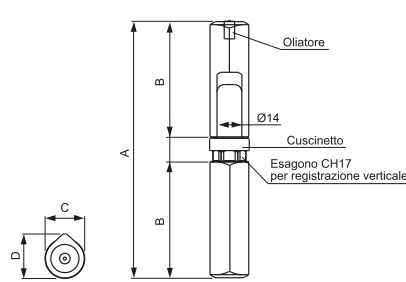
Art. 175

## Cerniera regolabile tornita con profilo a goccia, perno ottonato



-  Adjustable turned hinge with brass covered pin
-  Paumelle réglable façonnée au tour avec pivot laitoné
-  Charnela torneada perfilada a gota con perno cubierto de latón
-  Formgepresstes einstellbares Tropfen-Anschweißband mit Messingstift.

Materiale: Acciaio grezzo

Art.	A	B	C	D	E	F	Peso(g)	Conf.
175	150	67	22	25	14	36	380	15

Art. 177

## Cerniera tornita a tre ali per Vasistas con perno ottone e grani di fissaggio

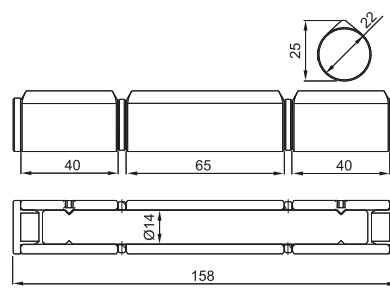

-  3 wings turned hinge for transom window brass with pin and fixing grub screws
-  Charnière 3 ailes façonnée au tour pour vasistas pivot laiton et grains fixation
-  Pernio torneado a tres alas para ventanas de toldo, con eje en latón y prisionero de fijación
-  Tropfen-Formgepresstes 3-teiliges einstellbares Anschweißband für Klappfenster mit Messings Stift und Befestigungsdübel

Materiale: Acciaio grezzo

Art.	Peso(g)	Conf.
177	398	15

Art. 114

## Cerniera tornita a tre ali registrabile con perni inox e grani di fissaggio



**Genius**

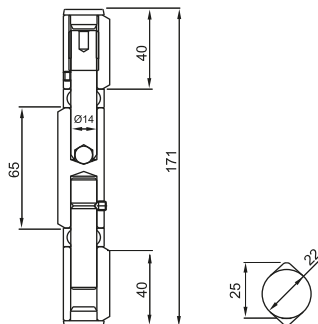

-  Adjustable three wings turned hinge drop profile with spacers
-  Charnière façonnée au tour réglable, profil en goutte, trois ailes, avec entretoises
-  Pernio torneado de tres alas, perfil de gota con separadores
-  Formgepresstes, verstellbares 3-teiliges Anschweißband mit Edelstahl-Stift und Befestigungsdübel.



Materiale: Acciaio grezzo

Art.	Peso(g)	Conf.
114	430	15

Art. 135

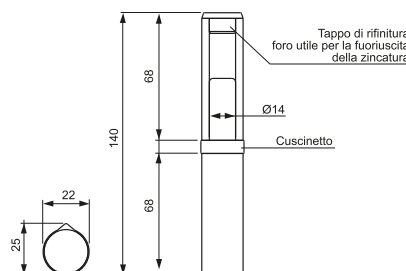
## Cerniera tornita a goccia con cuscinetto e tappo in plastica, perno ottone estraibile







-  Turned hinge with thrust bearing and plastic cap, extractable brass pin
-  Paumelle façonnée avec roulement et capuchon plastique, pivot en laiton
-  Charnela torneada con rodamiento y tapon plastico, perno en latón
-  Formgepresstes, Tropfen-Anschweißband mit Kugellager, Kunststoffkappe und ausziehbarem Messings Stift

Materiale: Acciaio grezzo

Art.	Peso(g)	Conf.
135	380	15

**Cerniera parigina con perno sfilabile** Art. 211

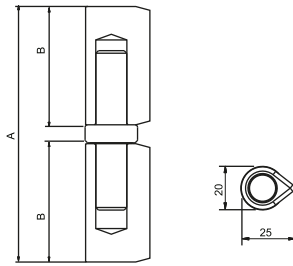

-  *Parisienne drop hinge with extractable pin*
-  *Charnière Parisienne profil en goutte avec pivot à extraire*
-  *Bisagra Pariginaa perfile de gota con pernio extraible*
-  *Pariser Anschweißband mit ausziehbarem Stift*



Materiale: Acciaio grezzo

Art.	A	B	Perno	Ø Perno	Peso(g)	Conf.
211.2.4	100	46	ferro	12	257	25
211.3.4	100	46	ottone	12	257	20

**Cerniera tornita a goccia con perno sfilabile** Art. 212



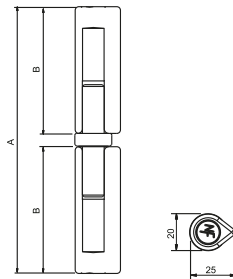

-  *Turned profile drop hinge with extractable pin*
-  *Paumelle façonnée au tour avec pivot à extraire*
-  *Charnela torneada con pernio extraible*
-  *Formgepresstess Anschweißband mit ausziehbarem Stift*





Materiale: Acciaio grezzo

Art.	A	B	Perno	Ø Perno	Peso(g)	Conf.
212.2.4	147	70	ferro	12	342	20
212.3.4	147	70	ottone	12	342	20

**Cerniera tornita con perno e cuscinetto** Art. 176 con cuscinetto

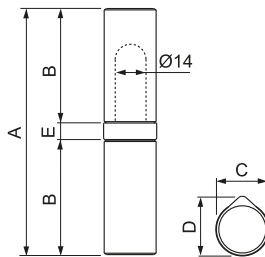
-  *Turned hinge with pin and bearing*
-  *Paumelle façonnée au tour avec pivot et roulement*
-  *Charnela torneada con pernio y cojinete*
-  *Gedrehtes Scharnier mit Stift und Lager*







Profilo trafilato 22 x 25mm 

Materiale: Acciaio grezzo

Art.	A	B	C	D	E	Perno	Peso(g)	Conf.
176.1.4	149	71	22	25	7	ferro	430	15
176.3.4	149	71	22	25	7	ottone	450	15
176.2.4	101	47	22	25	7	ferro	282	25
176.4.4	101	47	22	25	7	ottone	286	25

**Cerniera tornita con perno e con rondella in ottone** Art. 176 con rondella

-  *Turned hinge with brass washer*
-  *Paumelle façonnée au tour avec pivot et rondella en laiton*
-  *Charnela torneada con pernio y arandela de laton*
-  *Gedrehtes Scharnier mit Messingstift und Unterlegscheibe*

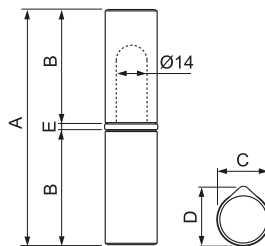

Profilo trafilato 22 x 25mm 

Materiale: Acciaio grezzo

Art.	A	B	C	D	E	Perno	Peso(g)	Conf.
176.1.5	145	71	22	25	3	ferro	425	15
176.3.5	145	71	22	25	3	ottone	440	15
176.2.5	97	47	22	25	3	ferro	276	25
176.4.5	97	47	22	25	3	ottone	280	25

Art. 217

Cerniera parigina con perno in acciaio o in ottone, sabbiata

CON CUSCINETTO

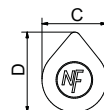
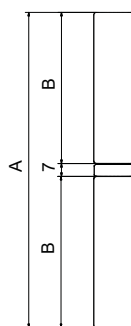

Materiale: Acciaio grezzo

Drop profile parisienne hinge with steel, brass pin, with thrust bearing, sandblasted

Charnière parisienne profil en goutte avec pivot acier ou laiton, avec palier de butée, sablé

Bisagra à profil de gota con pernio interior en acero o latón, con rodamiento, chorreado

Pariser Anschweißband mit Kugellager. Aus Stift aus Stahl, Edelstahl oder Messing, sandgestrahlt

CON RONDELLA

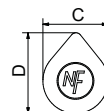
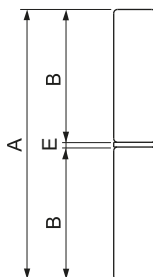

Materiale: Acciaio grezzo

Drop profile parisienne hinge with steel, or brass pin, with thrust washer sandblasted

Charnière parisienne profil en goutte avec pivot acier ou laiton, avec rondelle de butée, sablé

Bisagra a perfil de gota con pernio interior en acero o latón, con arandela, chorreado

Pariser Anschweißband mit Scheibe. Aus Stift aus Stahl, Edelstahl oder Messing, sandgestrahlt

## CON CUSCINETTO / WITH THRUST BEARING

Art.	A	B	C	D	Perno	Peso(g)	Conf.	Ø Perno
217/18x100.2.4	100	46,5	18	22	inox	200	25	10
217/18x100.3.4	100	46,5	18	22	ottone	200	25	10
217/18x120.2.4	120	56,5	18	22	inox	240	20	10
217/18x120.3.4	120	56,5	18	22	ottone	250	20	10
217/20x140.2.4	140	66,5	20	25	acciaio	320	20	12
217/20x140.3.4	140	66,5	20	25	ottone	330	20	12
217/20x160.2.4	160	76,5	20	25	acciaio	420	15	12
217/20x160.3.4	160	76,5	20	25	ottone	430	15	12
217/23x180.2.4	180	86,5	23	28	acciaio	600	10	14
217/23x180.3.4	180	86,5	23	28	ottone	610	10	14
217/23x200.2.4	200	96,5	23	28	acciaio	680	8	14
217/23x200.3.4	200	96,5	23	28	ottone	690	8	14



Profilo stampato 18 x 22mm



Profilo stampato 20 x 25mm



Profilo stampato 23 x 28mm



## CON RONDELLA IN OTTONE / WITH BRASS PIN

Art.	A	B	C	D	E	Perno	Peso(g)	Conf.	Ø Perno
217/10.2.5	60	29	10	12	2	acciaio	40	80	6
217/10.3.5	60	29	10	12	2	ottone	40	80	6
217/13.2.5	80	38,5	13	16	2,5	acciaio	90	50	7
217/13.3.5	80	38,5	13	16	2,5	ottone	90	50	7
217/18x100.2.5	96	46,5	18	22	3	inox	200	25	10
217/18x100.3.5	96	46,5	18	22	3	ottone	200	25	10
217/18x120.2.5	116	56,5	18	22	3	inox	240	20	10
217/18x120.3.5	116	56,5	18	22	3	ottone	250	20	10
217/20x140.2.5	135,5	66,5	20	25	2,5	acciaio	330	20	12
217/20x140.3.5	135,5	66,5	20	25	2,5	ottone	340	20	12
217/20x160.2.5	155,5	76,5	20	25	2,5	acciaio	420	15	12
217/20x160.3.5	155,5	76,5	20	25	2,5	ottone	430	15	12
217/23x180.2.5	176	86,5	23	28	3	acciaio	600	10	14
217/23x180.3.5	176	86,5	23	28	3	ottone	610	10	14
217/23x200.2.5	196	96,5	23	28	3	acciaio	680	8	14
217/23x200.3.5	196	96,5	23	28	3	ottone	690	8	14



Profilo stampato 10 x 12mm



Profilo stampato 13 x 16mm



Profilo stampato 18 x 22mm



Profilo stampato 20 x 25mm





Profilo stampato 23 x 28mm



Cerniera parigina con perno in acciaio, inox, ottone

Art. 197

 Drop profile parisienne hinge with steel, stainless steel or brass pin, with thrust bearing

 Charnière parisienne profil en goutte avec pivot acier, acier inox ou laiton, avec palier de butée

 Bisagra à perfil de gota con pernio interior en acero, acero inox o latón, con rodamiento

 Pariser Anschweißband mit Kugellager. Aus Stift aus Stahl, Edelstahl oder Messing

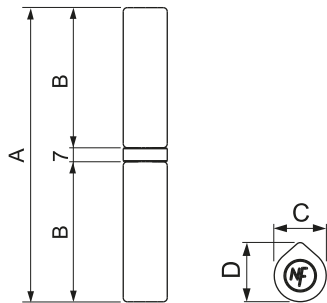



CON CUSCINETTO



Materiale: Acciaio grezzo

 Steel, stainless steel or brass pin, parisienne hinge with washer

 Charnière parisienne en acier, acier inox ou laiton, avec rondelle

 Bisagra de acero, acero inoxidable o latón con arandela

 Stiftscharnier aus Stahl, rostfreiem Stahl oder Messing mit Unterlegscheibe

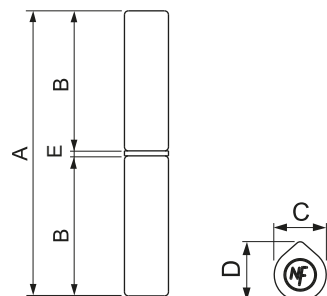



CON RONDELLA





Materiale: Acciaio grezzo

CON CUSCINETTO / WITH THRUST BEARING

	Art.	A	B	C	D	Perno	Peso(g)	Conf.	Ø Perno
 Profilo stampato 18 x 22mm	197/18.1.4	147	70	18	22	inox	252	25	10
	197/18.2.4	147	70	18	22	acciaio	252	25	10
	197/18.3.4	147	70	18	22	ottone	255	25	10
 Profilo stampato 20 x 25mm	197/20.1.4	147	70	20	25	inox	330	20	12
	197/20.2.4	147	70	20	25	acciaio	330	20	12
	197/20.2.4.140	140	66.5	20	25	acciaio	318	20	12
	197/20.3.4	147	70	20	25	ottone	333	20	12
 Profilo stampato 22 x 25mm	197/22.1.4	147	70	22	25	inox	368	15	14
	197/22.2.4	147	70	22	25	acciaio	368	15	14
	197/22.3.4	147	70	22	25	ottone	374	15	14

CON RONDELLA IN OTTONE / WITH BRASS PIN

	Art.	A	B	C	D	E	Perno	Peso(g)	Conf.	Ø Perno
 Profilo stampato 18 x 22mm	197/18.1.5	135	66,5	18	22	2	inox	248	25	10
	197/18.2.5	135	66,5	18	22	2	acciaio	248	25	10
	197/18.3.5	135	66,5	18	22	2	ottone	250	25	10
 Profilo stampato 20 x 25mm	197/20.1.5	142.5	70	20	25	2.5	inox	325	20	12
	197/20.2.5	142.5	70	20	25	2.5	acciaio	335	20	12
	197/20.3.5	142.5	70	20	25	2.5	ottone	330	20	12
 Profilo stampato 22 x 25mm	197/22.1.5	143	70	22	25	3	inox	365	15	14
	197/22.2.5	143	70	22	25	3	acciaio	365	15	14
	197/22.3.5	143	70	22	25	3	ottone	370	15	14



## Art. 194

## Cuscinetto reggispinta in acciaio zincato e cementato

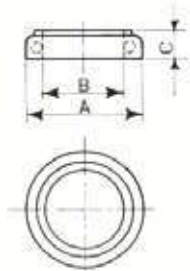

Materiale: Acciaio Zincato nero (.77)  
 Materiale: Acciaio Zincato bianco (.76)  
 Materiale: Acciaio Zincato giallo (.75)

- Steel galvanized and cemented thrust bearing
- Palier de butée en acier zingué moulé et cimenté
- Cojinete en acero cincado y cementado
- Druckkugellager aus verzinktem und zementiertem Stahl

Art.	Art.	Art.	A	B	C	Peso(g)	Conf
194/9.77	194/9.76	194/9.75	15	9	6	4	200
194/10.77	194/10.76	194/10.75	18,5	10	7	6	200
194/11.77	194/11.76	194/11.75	19,5	11	7	7	200
194/12.77	194/12.76	194/12.75	20,5	12	7	7,5	200
194/13.77	194/13.76	194/13.75	24,5	13	7	12	100
194/14.77	194/14.76	194/14.75	22,5	14	7	10	100
194/16.77	194/16.76	194/16.75	24,5	16	7	10	100
194/20.77	194/20.76	194/20.75	28,5	20	7	11	100



## Art. 127

## Rondella per cerniera

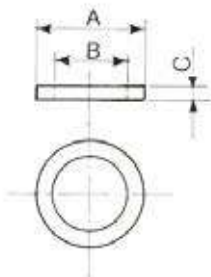

Materiale: Zincato / Ottone

Art.	Var.	A	B	C	Peso(g)	Conf.
127/12	Zincato	12	8,3	2	6	100
127/14	Zincato	14	10,3	2	14	100
127/16	Zincato	16	11,3	2	16	100
127/18	Zincato	18	12,3	2	22	100
127/20	Zincato	20	14,3	2	22	100
127/28	Ottone	28	20,5	4	24	100

- Washer for hinges
- Rondelle pour charnières
- Arendela para charnelas
- Zwischenring für Scharnier

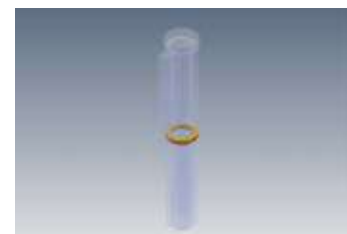

## Art. 195

## Cappuccio e tappo in silicone per Art. 197

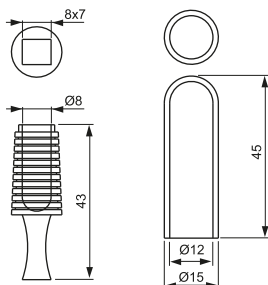

Materiale: Silicone bianco





Art.	Var.	Peso(g)	Conf.	Imb.
195.1	Cappuccio	4	20	50
195.2	Tappo	4	20	50

- Silicone cap and plug for Art. 197
- Capuchon et bouchon en silicone pour Art. 197
- Tapa y tapón de silicona para Art. 197
- Silikonkappe und Stopfen für Art. 197



Piolo di sicurezza per porte corazzate

Art. 147/4 - 147/5

-  Safety-peg for armoured doors
-  Piquet de sureté pour portes blindées
-  Estaca de seguridad para puertas blindadas
-  Sicherheitsdom für Gepanzerten Türen

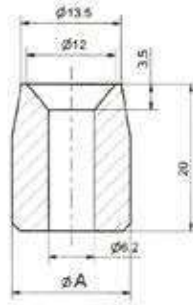





Materiale: Acciaio zincato

Art.	A	Peso(g)	Conf.
147/4	16	24	300
147/5	20	36	300

Piolo di sicurezza per porte corazzate

Art. 147 - 147/1

-  Safety-peg for armoured doors
-  Piquet de sureté pour portes blindées
-  Estaca de seguridad para puertas blindadas
-  Sicherheitsdom für Gepanzerten Türen

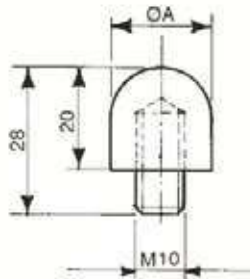





Materiale: Acciaio grezzo

Art.	A	Peso(g)	Conf.
147	20	20	250
147/1	16	16	250

Piolo di sicurezza per porte corazzate

Art. 147/2 - 147/3

-  Safety-peg for armoured doors
-  Piquet de sureté pour portes blindées
-  Estaca de seguridad para puertas blindadas
-  Sicherheitsdom für Gepanzerten Türen

Art. 147/2



Art. 147/3

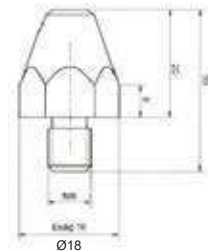

Art. 147/2



Art. 147/3



Materiale: Acciaio zincato

Art.	Var.	Peso(g)	Conf.
147/2	Cilindrico	30	600
147/3	Esagonale	30	600

# NOVA-FERR srl

CERNIERE PER USI VARI  
HINGES FOR VARIOUS USES



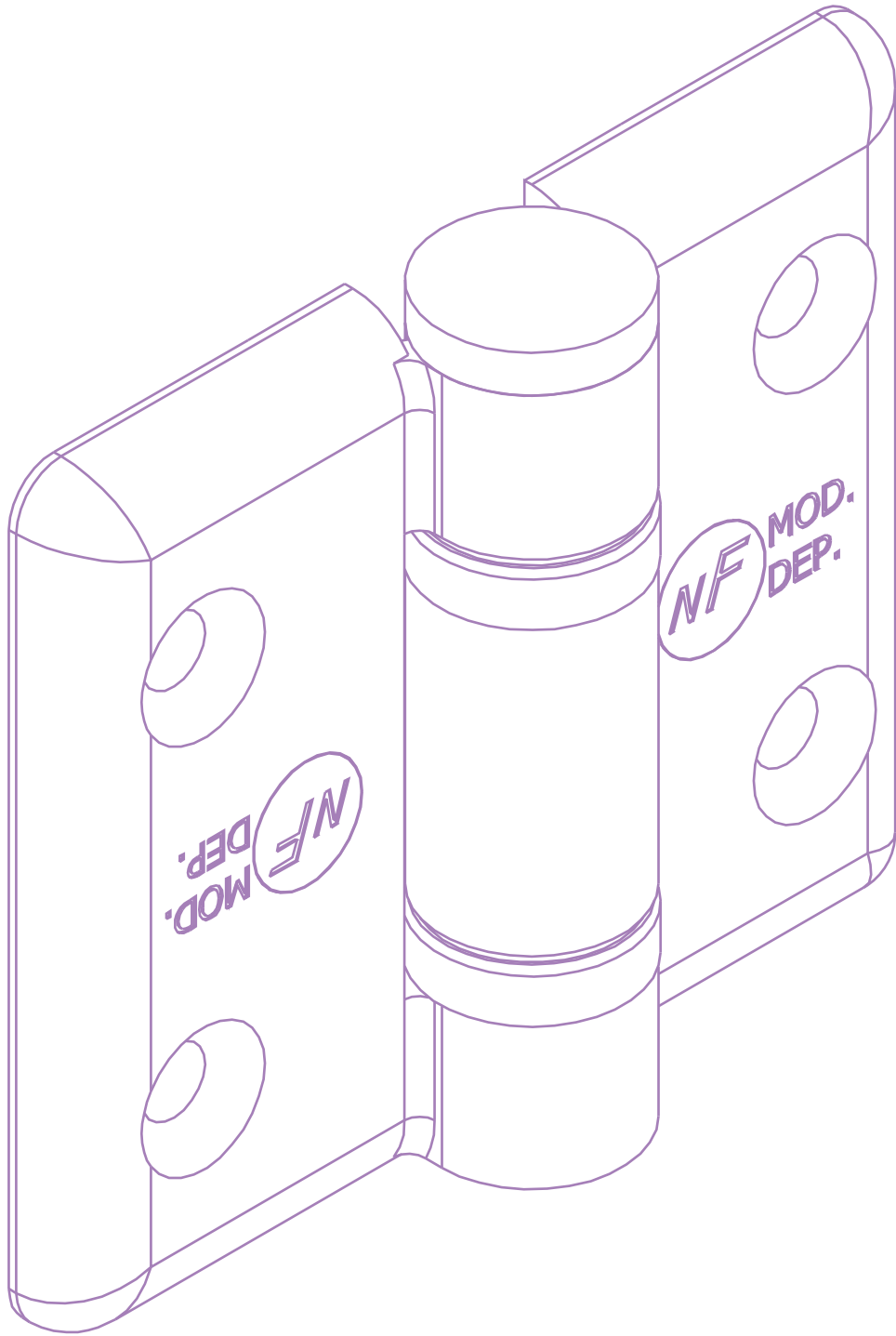

# CERNIERE PER USI VARI

Hinges for various uses - Charnières pour divers usages  
Bisagras para diversos usos  
Scharniere für verschiedene Anwendungen

**CATALOGO  
N.25**

## Art. 136

## Cerniera a due ali con tappo in ferro

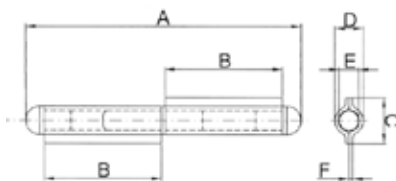

Materiale: Acciaio grezzo - Tappi saldati

Art.	A	B	C	D	E	F	Peso(g)	Conf.
136/6	60	27	22	12	8	2	58	50
136/8	80	37	22	12	8	2	80	50
136/10	100	46	26	14,5	10	2	105	50
136/12	120	55	28	15	10	2,5	140	30
136/14	140	65	29	16	11	2,5	195	30
136/17	170	80	30	18	12	3	278	10
136/20	200	95	36	20	14	3	376	12

Two wings hinge with iron cap

Charnière à deux ailes avec capuchon en fer

Charnela de dos alas con tapon en hierro

2-teiliges Anschweißband mit Eisenkappe



## Art. 179

## Cerniera a due ali

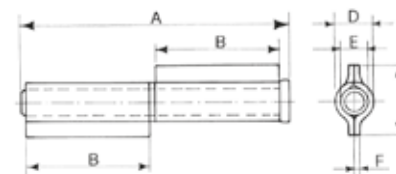

Materiale: Acciaio grezzo - Perno in acciaio zincato

Art.	A	B	C	D	E	F	Peso(g)	Conf.
179/6	60	27	22	12	8	2	58	40
179/8	80	37	22	12	8	2	80	40
179/10	100	46	26	14,5	10	2	136	40
179/12	120	55	28	15	10	2,5	180	25
179/14	140	65	29	16	11	2,5	242	25
179/14S	140	65	29	18	12	3	250	20
179/17	170	80	30	18	12	3	368	15
179/20	200	95	36	20	14	3	526	20
1179/10	100	46	26	14,5	10	2	136	40
1179/14	140	65	29	16	11	2,5	242	25

Two wings hinge

Charnière à deux ailes

Charnela de dos alas

2-teiliges Anschweißband



●—INOX

●—INOX

## Art. 180

## Cerniera a tre ali

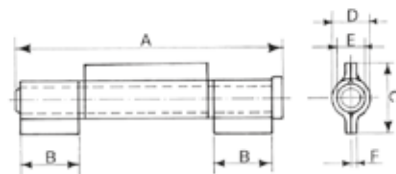

Materiale: Acciaio grezzo - Perno in acciaio zincato

Art.	A	B	C	D	E	F	Peso(g)	Conf.
180/8	80	17,5	22	12	8	2	78	40
180/10	100	21,5	26	14,5	10	2	132	40
180/12	120	27	28	15	10	2,5	186	25
180/14	140	32	29	16	11	2,5	246	25
180/14S	140	35	29	18	12	3	246	20
180/17	170	39	30	18	12	3	370	15
180/20	200	46,5	36	20	14	3	528	20
1180/10	100	21,5	26	14,5	10	2	132	40
1180/14	140	32	29	16	11	2,5	246	25

Three wings hinge

Paumelle à trois ailes

Charnela de tres alas

3-Flügel Anschweißband



●—INOX

●—INOX

Ficcia a due ali perno Ø20 con cuscinetto (C) o rondella in ottone (R)

Art. 137

Two wings hinge with Ø20 pin with thrust bearing (C) or brass washer (R)

Charnière à deux ailes avec pivot Ø20 avec roulement (C) ou rondelle en laiton (R)

Charnela de dos alas con pierno Ø20 con cojinete (C) o arendela en latón (R)

2-teiliges Anschweißband mit Ø20 Stift und Kugellager (C) oder Zwischenring aus Messing (R)

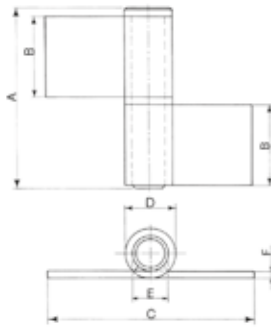

Materiale: Acciaio grezzo

Art.	Var.	A	B	C	D	E	F	Peso(g)	Conf.
137/10.4	C	105	47	122	28	20	4	660	8
137/20.4	C	210	98	122	28	20	4	1.300	6
137/10.5	R	105	47	122	28	20	4	655	8
137/20.5	R	210	98	122	28	20	4	1.295	6



Ficcia a 3 ali con rondella in ottone (R)

Art. 182

Three wings hinge with brass washer

Paumelle à trois ailes avec rondelle en laiton

Charnela de tres alas con arendela en latón

3-teiliges Scharnier mit Unterlegscheibe aus Messing

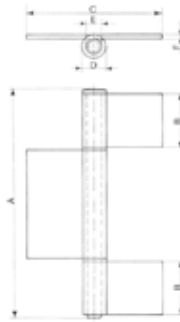

Materiale: Acciaio grezzo

Art.	Var.	A	B	C	D	E	F	Peso(g)	Conf.
182/11	R	110	27	81	14	8	2,5	212	10
182/14	R	140	33	91	18	12	3	426	10
182/17	R	170	42	105	20	12	3,5	600	10
182/20	R	200	47	121	23	14	4	975	10



Ficcia a tre ali perno Ø20 con cuscinetto (C) o rondella in ottone (R)

Art. 138

Three wings hinge with Ø20 pin with thrust bearing (C) or brass washer (R)

Charnière à trois ailes avec pivot Ø20 et roulement (C) ou rondelle en laiton (R)

Charnela de tres alas con pierno Ø20 con cojinete (C) o arendela en latón (R)

2-teiliges Anschweißband mit Ø20 Stift und Kugellager (C) oder Zwischenring aus Messing (R)

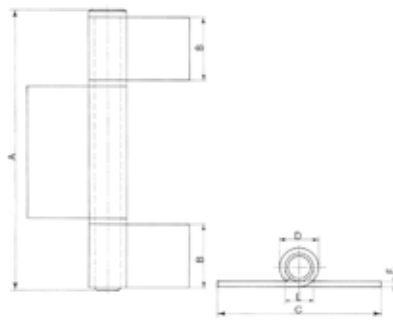

Materiale: Acciaio grezzo

Art.	Var.	A	B	C	D	E	F	Peso(g)	Conf.
138/20.4	C	210	47	122	28	20	4	1.300	6
138/20.5	R	210	47	122	28	20	4	1.295	6



## Art. 139

### Ficcia a quattro ali perno Ø20 con cuscinetto (C) o rondella in ottone (R)

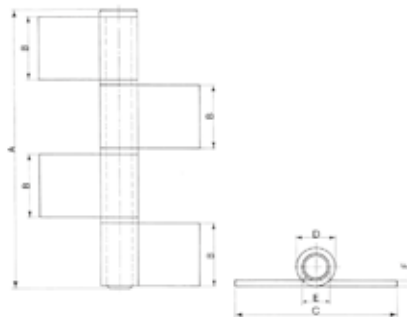

Four wings hinge with Ø20 pin with thrust bearing (C) or brass washer (R)

Charnière à quatre ailes avec pivot Ø20 et roulement (C) ou rondelle en laiton (R)

Charnela de cuatro alas con pierno Ø20 con cojinete (C) o arendela en latón (R)

4-teiliges Anschweißband mit Ø20 Stiff mit Kugellager (C) oder Zwischenring aus Messing (R)

Materiale: Acciaio grezzo

Art.	Var.	A	B	C	D	E	F	Peso(g)	Conf.
139/20.4	C	210	47	122	28	20	4	1.300	6
139/20.5	R	210	47	122	28	20	4	1.295	6



## Art. 185

### Cerniera pesante a due ali aperte con cuscinetto (C) o rondella in ottone (R)

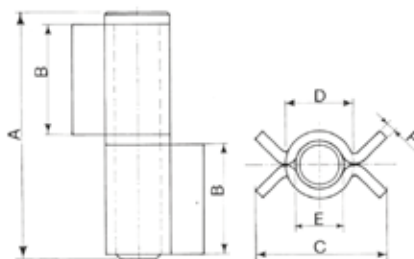

Two opened wings heavy hinge with thrust bearing (C) or brass washer (R)

Charnière lourde à deux ailes ouvertes avec roulement (C) ou rondelle en laiton (R)

Charnela pesada abierta de dos alas con cojinete (C) o arendela latón (R)

Schwerlastscharnier mit 2 offenen Flügeln mit Kugellager (C) oder Zwischenring aus Messing (R)

Materiale: Acciaio grezzo

Art.	Var.	A	B	C	D	E	F	Peso(g)	Conf.
185/10.4	C	105	47	56	28	20	4	590	10
185/20.4	C	210	98	56	28	20	4	1.180	8
185/10.5	R	109	47	59	28	20	4	585	10
185/20.5	R	210	98	56	28	20	4	1.175	8



## Art. 186

### Cerniera pesante a tre ali aperte con cuscinetto (C) o rondella in ottone (R)

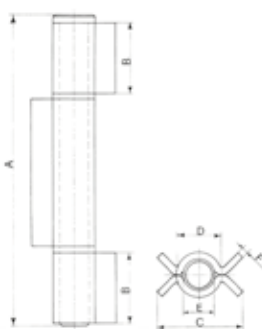

Three opened wings heavy hinge with thrust bearing (C) or brass washer (R)

Charnière lourde à trois ailes ouvertes avec roulement (C) ou rondelle en laiton (R)

Charnela pesada abierta de tres alas con cojinete (C) o arendela latón (R)

Schwerlastscharnier mit 3 offenen Flügeln mit Kugellager (C) oder Zwischenring aus Messing (R)

Materiale: Acciaio grezzo

Art.	Var.	A	B	C	D	E	F	Peso(g)	Conf.
186/20.4	C	210	47	56	28	20	4	1.165	8
186/20.5	R	210	47	56	28	20	4	1.160	8





**Cerniera pesante a quattro ali aperte con cuscinetto (C) o rondella in ottone (R)**

Art. 187

 Four opened wings heavy hinge with thrust bearing (C) or brass washer (R)

 Charnière lourde à quatre ailes ouvertes avec roulement (C) ou rondelle en laiton (R)

 Charnela pesada abierta de cuatro alas con cojinete (C) o arendela latón (R)

 Schwerlastscharnier mit 4 offenen Flügeln mit Kugellager (C) oder Zwischenring aus Messing (R)

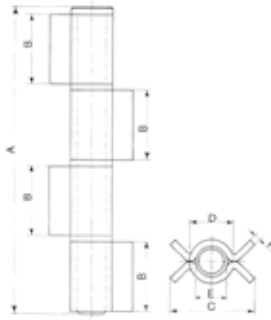

Materiale: Acciaio grezzo





Art.	Var.	A	B	C	D	E	F	Peso(g)	Conf.
187/20.4	C	210	47	56	28	20	4	1.165	8
187/20.5	R	210	47	56	28	20	4	1.160	8

**Cerniera pesante a due ali lunghe chiuse con cuscinetto (C) o con rondella in ottone (R)**

Art. 188

 Two wings hinge with Ø20 pin with thrust bearing (C) or brass washer (R)

 Charnière à deux ailes avec pivot Ø20 avec roulement (C) ou rondelle en laiton (R)

 Charnela de dos alas con pierno Ø20 con cojinete (C) o arendela en latón (R)

 Schwerlastscharnier mit 2 langen geschlossenen Flügeln mit Kugellager (C) oder Zwischenring aus Messing (R)

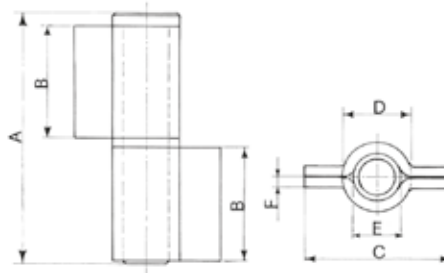

Materiale: Acciaio grezzo





Art.	Var.	A	B	C	D	E	F	Peso(g)	Conf.
188/10.4	C	105	47	62	28	20	4	590	10
188/20.4	C	210	98	62	28	20	4	1.160	8
188/10.5	R	105	47	62	28	20	4	585	10
188/20.5	R	210	98	62	28	20	4	1.155	8

**Cerniera pesante a tre ali lunghe chiuse con cuscinetto (C) o con rondella in ottone (R)**

Art. 189

 Three wings hinge with Ø20 pin with thrust bearing (C) or brass washer (R)

 Charnière à trois ailes avec pivot Ø20 avec roulement (C) ou rondelle en laiton (R)

 Charnela de tres alas con pierno Ø20 con cojinete (C) o arendela en latón (R)

 Schwerlastscharnier mit 3 langen geschlossenen Flügeln mit Kugellager (C) oder Zwischenring aus Messing (R)

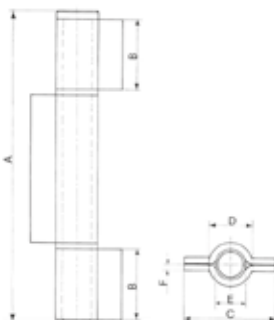

Materiale: Acciaio grezzo



Art.	Var.	A	B	C	D	E	F	Peso(g)	Conf.
189/20.4	C	210	47	62	28	20	4	1.160	8
189/20.5	R	210	47	62	28	20	4	1.155	8



## Art. 190 Cerniera pesante a quattro ali lunghe chiuse con cuscinetto (C) o con rondella in ottone (R)

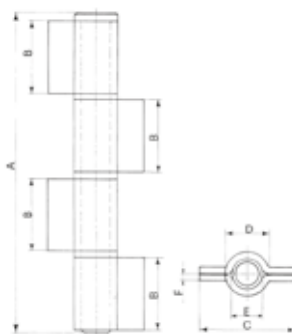

- Four wings hinge with Ø20 pin with thrust bearing (C) or brass washer (R)
- Charnière à quatre ailes avec pivot Ø20 avec roulement (C) ou rondelle en laiton (R)
- Charnela de cuatro alas con pierno Ø20 con cojinete (C) o arendela en latón (R)
- Schwerlastschammiere mit 4 langen geschlossenen Flügeln mit Kugellager (C) oder Zwischenring aus Messing (R)

Materiale: Acciaio grezzo

Art.	Var.	A	B	C	D	E	F	Peso(g)	Conf.
190/20.4	C	210	47	56	28	20	4	1.160	8
190/20.5	R	210	47	56	28	20	4	1.155	8



## Art. 191 Cerniera pesante a due ali corte chiuse con cuscinetto (C) o rondella in ottone (R)

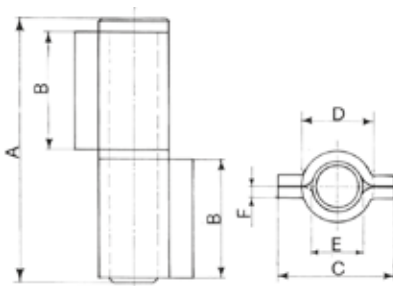

- Two closed short wings heavy hinge with thrust bearing (C) or brass washer (R)
- Charnière lourde à deux ailes fermées et courtes avec roulement (C) ou rondelle en laiton (R)
- Charnela pesada cerradas y cortas de dos alas con cojinete (C) o arendela en latón (R)
- Schwerlastschammiere mit 2 kurzen geschlossenen Flügeln mit Kugellager (C) oder Zwischenring aus Messing (R)

Materiale: Acciaio grezzo

Art.	Var.	A	B	C	D	E	F	Peso(g)	Conf.
191/10.4	C	105	47	48	28	20	4	550	12
191/20.4	C	210	98	48	28	20	4	1.190	10
191/10.5	R	105	47	48	28	20	4	540	12
191/20.5	R	210	98	48	28	20	4	1.180	10



## Art. 192 Cerniera pesante a tre ali corte chiuse con cuscinetto (C) o rondella in ottone (R)

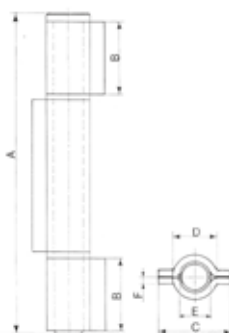

- Three closed short wings heavy hinge with thrust bearing (C) or brass washer (R)
- Charnière lourde à trois ailes fermées et courtes avec roulement (C) ou rondelle en laiton (R)
- Charnela pesada cerradas y cortas de tres alas con cojinete (C) o arendela en latón (R)
- Schwerlastschammiere mit 3 kurzen geschlossenen Flügeln mit Kugellager (C) oder Zwischenring aus Messing (R)





Materiale: Acciaio grezzo

Art.	Var.	A	B	C	D	E	F	Peso(g)	Conf.
192/20.4	C	210	47	48	28	20	4	1.080	10
192/20.5	R	210	47	48	28	20	4	1.075	10



**Cerniera pesante a quattro ali corte chiuse con cuscinetto (C) o rondella in ottone (R)**

**Art. 193**

-  *Four closed short wings heavy hinge with thrust bearing (C) or brass washer (R)*
-  *Charnière lourde à quatre ailes fermées et courtes avec roulement (C) ou rondelle en laiton (R)*
-  *Charnela pesada cerradas y cortas de cuatro alas con cojinete (C) o arendela en latón (R)*
-  *Schwerlastscharnier mit 4 kurzen geschlossenen Flügeln mit Kugellager (C) oder Zwischenring aus Messing (R)*

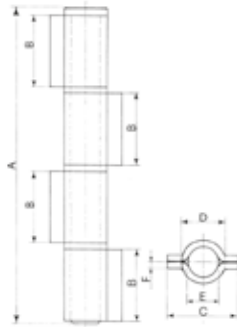





Materiale: Acciaio grezzo



Art.	Var.	A	B	C	D	E	F	(g)	Conf.
193/20.4	C	210	47	48	28	20	4	1.080	8
193/20.5	R	210	47	48	28	20	4	1.075	10

**Cerniera centrale nera ad avvitare completa di cover**

**Art. 3750**

-  *Black painted central hinge to be screwed complete with cover*
-  *Charnière centrale à visser vernie noire complet avec couvercle*
-  *Bisagra central barnizada negra a atornillar completo con tapa*
-  *Zentrale schwarz lackiertes Scharnier zum Schrauben komplett mit Deckel*

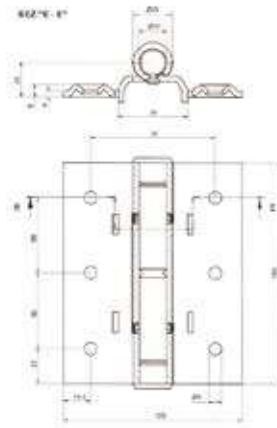

Materiale: Acciaio verniciato  
Cover copertura: Nylon



Art.	Peso(g)	Conf.
3750	1.250	8



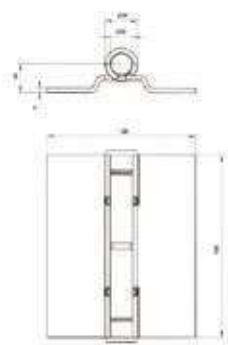

## Art. 3850



Materiale: Acciaio grezzo

Art.	Peso(g)	Conf.
3850	1.250	10

## Cerniera centrale a saldare

-  Central hinge to be welded
-  Charnière centrale à souder
-  Bisagra central a soldar
-  Zentrales Scharnier zum Schweißen





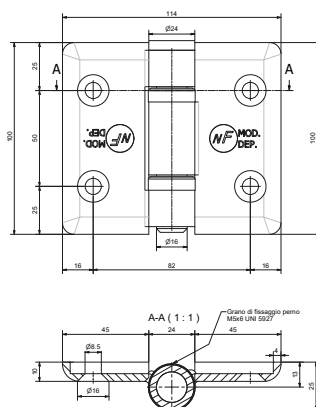

## Art. 3100/P



Materiale: Acciaio Verniciato

Art.	Peso(g)	Conf.
3100/P	680	10

## Cerniera centrale in acciaio verniciata nera ad avvitare, piana

-  Black painted flat central hinge to be screwed
-  Charnière centrale plate à visser vernie noire
-  Bisagra central plana de acero barnizada negra a atornillar
-  Zentrales flaches Scharnier aus lackiertem Stahl zum Anschrauben





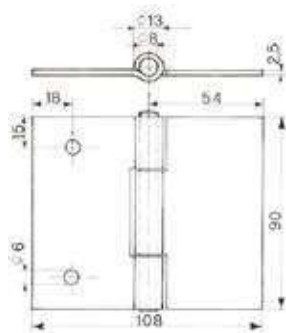

## Art. 126



Materiale: Acciaio grezzo

Art.	Peso(g)	Conf.
126	262	20

## Cerniera per porta di cantina

-  Hinge for cellar door
-  Charnière pour porte de cave
-  Bisagra para puerta de sótano
-  Scharnier für Kellertür



Cerniera superiore e inferiore per porte tagliafuoco

Art. 113

Upper and lower hinge for anti-fire doors

Charnière et inférieure supérieure pour portes coupe-feu

Bisagra superior e inferior para puertas cortafuego

Oberes und unteres Scharnier für Brandschutztür

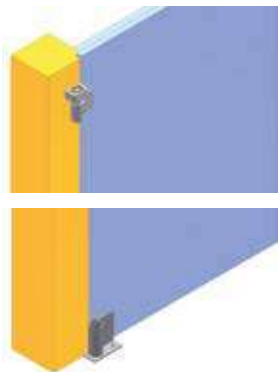
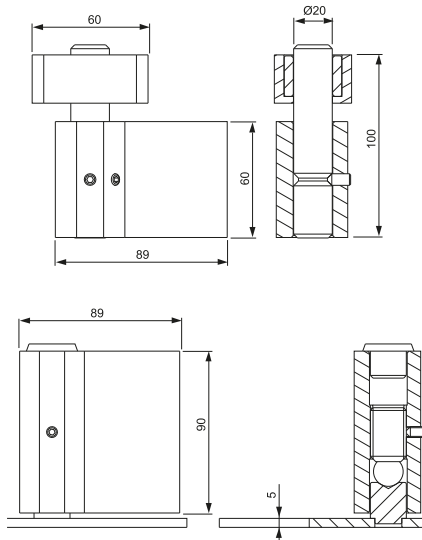

Materiale: Acciaio grezzo

Art.  
113

Peso(g)	Conf.
1.345	2

Cerniera registrabile per persiana

Art. 716 - 717

Adjustable hinge for shutter

Charnière réglable pour volet

Bisagra ajustable para persiana

Einstellbar scharnier für persisch

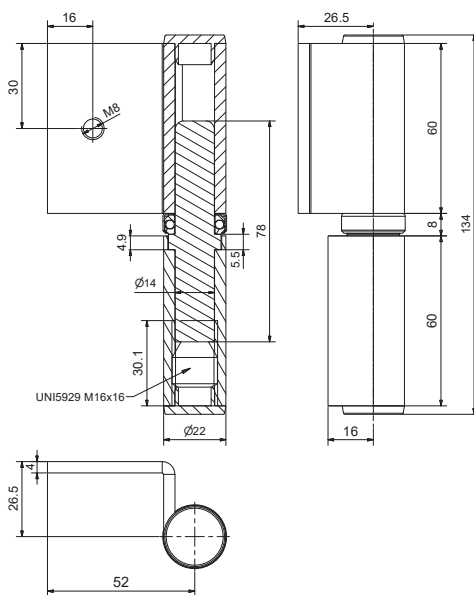

Materiale: Acciaio grezzo

Art.	Variante
716	DX
717	SX

Peso(g)	Conf.
1.345	2
1.345	2

# NOVA-FERR srl

ACCESSORI PER GRATE DI SICUREZZA  
ACCESSORIES FOR SAFETY GRATES

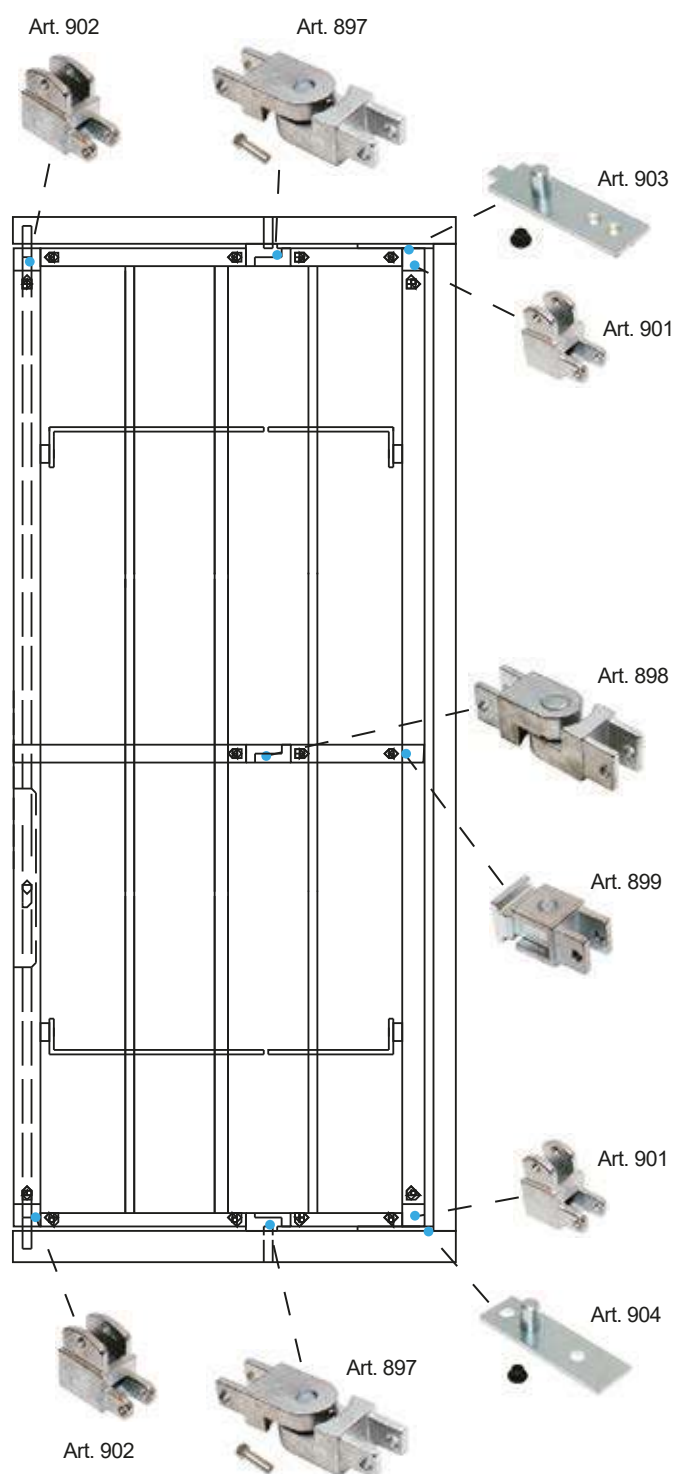
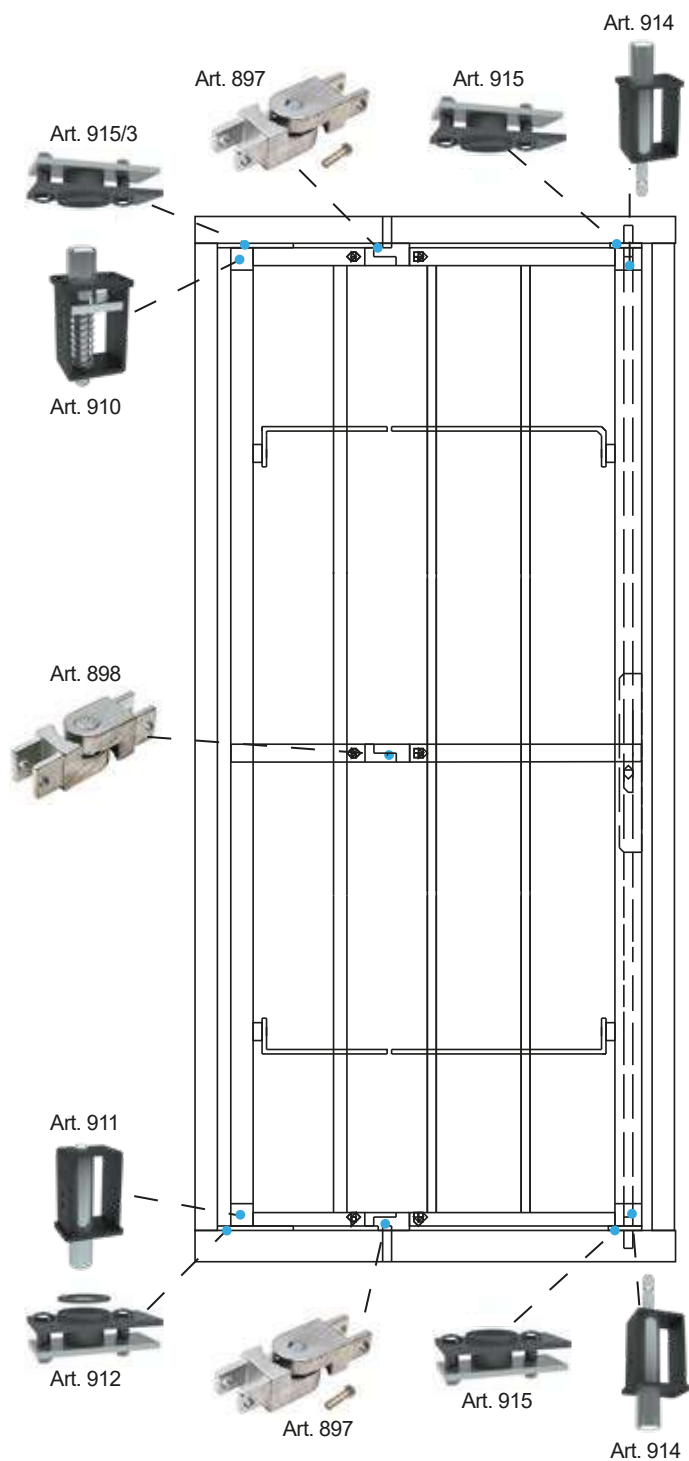

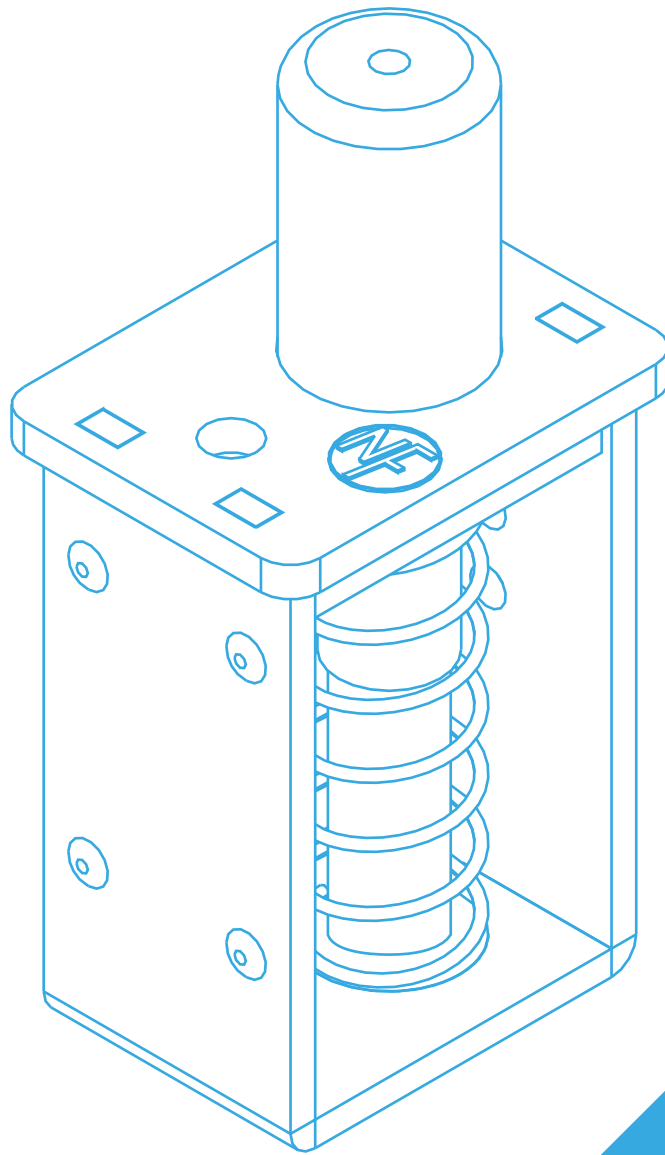
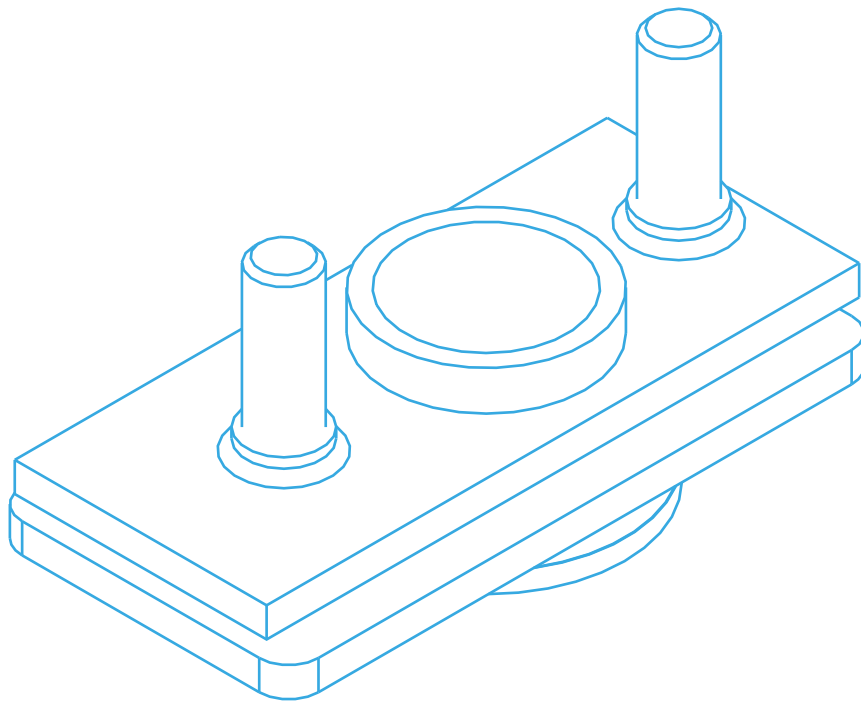

# ACCESSORI PER GRATE DI SICUREZZA

Safety gates accessories - Accessoires pour grilles de sécurité  
Accesorios para rejilla de seguridad  
Zubehör für Sicherheitsgitter

CATALOGO  
N.25

NUOVO SISTEMA DI CARDINE REGOLABILE A SGANCIO RAPIDO  
NEW QUICK RELEASE ADJUSTABLE HINGE SYSTEM

**NF** **Rapido**  
Patented



1|

2|



3|

L'unico sul mercato con lo speciale dispositivo di regolazione

- 1| Cardine superiore con vite di bloccaggio
- 2| Cardine inferiore con vite di bloccaggio
- 3| Dispositivo di regolazione piastre|boccola|rondella

**CARATTERISTICHE TECNICHE**

Perno Ø 16 mm in acciaio

Piastrina di riscontro INOX

Zincatura nera ad alta resistenza alla corrosione

Montaggio senza saldatura

Blocco di sicurezza

Dispositivo di regolazione dell'anta

Rondella inferiore antifrizione



Inserire il cardine superiore

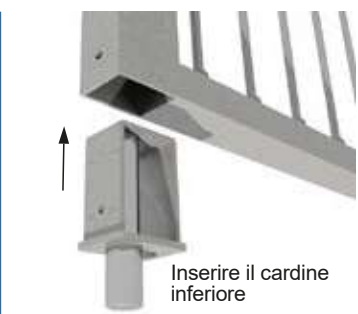

Inserire il cardine inferiore

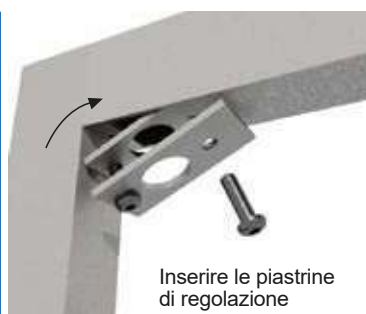

Inserire le piastrine di regolazione



Inserire le boccole nelle apposite sedi



Inserire le rondelle e posizionare l'anta



Retrarre il perno superiore per infilare l'anta



Posizionare l'anta in asse e serrare tutte le viti di bloccaggio

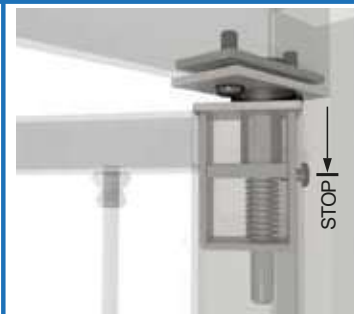

Funzione blocco di sicurezza



Per smontare l'anta rimuovere la vite di blocco

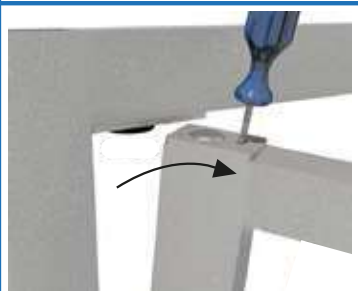

Retrarre il perno superiore per rimuovere l'anta

Per profili 40x30mm  
Sp.2mm

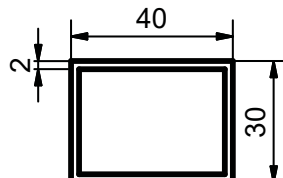





Guarda il video del montaggio sul canale Youtube NOVAFERR  
[www.youtube.com/user/novaferr](http://www.youtube.com/user/novaferr)



**Cardine superiore RAPIDO**

**Art. 910**

-  "RAPIDO" Upper quick release pintle hinge
-  "RAPIDO" Gond à déclic rapide, partie supérieure
-  Bisagra de desenganche "RAPIDO", parte superior
-  "RAPIDO" oberes torband mit schnellauslösung

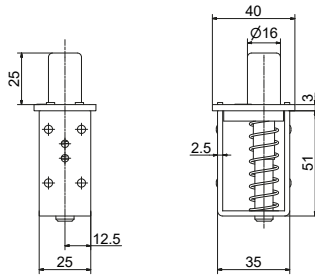

**Brevettato  
Patented**







Materiale: Acciaio Inox

Art.	Tubolare	Peso(g)	Conf.
910	30x40	160	10

**Cardine inferiore RAPIDO**

**Art. 911**

-  "RAPIDO" Bottom quick release pintle hinge
-  "RAPIDO" gond à déclic rapide, partie inférieure
-  Bisagra de desenganche "RAPIDO" parte inferior
-  "RAPIDO" Unteres torband mit schnellauslösung

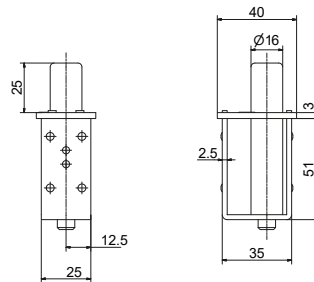

**Brevettato  
Patented**







Materiale: Acciaio Inox

Art.	Tubolare	Peso(g)	Conf.
911	30x40	210	10

**Dispositivo di regolazione dell'anta RAPIDO**

**Art. 912**

-  "RAPIDO" Adjusting device for swing gates
-  "RAPIDO" Dispositif d'ajustement du volet
-  "RAPIDO" Dispositivo de ajuste de la hoja
-  "RAPIDO" Einstellvorrichtung der Tür

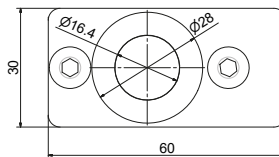
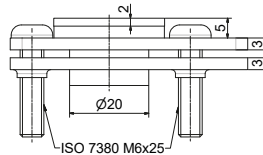

Materiale: Acciaio Inox

Art.	Tubolare	Peso(g)	Conf.
912	30x40	160	10

**Kit RAPIDO**

**Art. 913**

-  "RAPIDO" kit
-  Kit "RAPIDO"
-  Kit "RAPIDO"
-  Kit "RAPIDO"



Materiale: Acciaio Inox

Art.	Peso(g)	Conf.
913	520	10



## Art. 914

## Puntale con guide RAPIDO

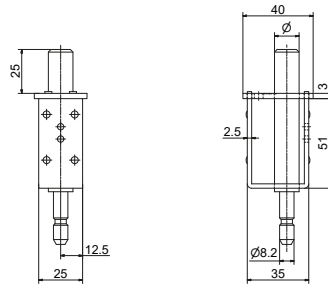

Materiale: Acciaio Inox

"RAPIDO" Ferrule with guiding rods

"RAPIDO" Embout avec guides

"RAPIDO" Férula con guías

"RAPIDO" Zwinge mit Führungen

Art.	Ø	Tubolare	Peso(g)	Conf.
<b>914</b>	10	30x40	150	10
<b>914/1</b>	12	30x40	170	10
<b>914/2</b>	14	30x40	190	10
<b>914/3</b>	16	30x40	200	10

## Art. 915

## Dispositivo di regolazione dell'anta per puntale RAPIDO

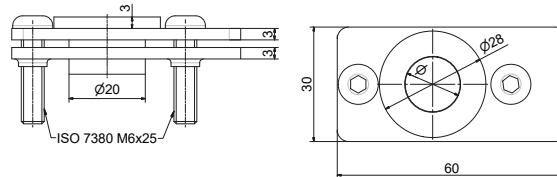

Materiale: Acciaio Inox

"RAPIDO" Ferrule device for wing adjusting

"RAPIDO" Dispositif à embouts pour le réglage de l'aile

"RAPIDO" Dispositivo con puntas para ajustar el ala

"RAPIDO" Vorrichtung mit Zwingen zum Einstellen des Flügels

Art.	Ø	Peso(g)	Conf.
<b>915</b>	10	160	10
<b>915/1</b>	12	160	10
<b>915/2</b>	14	160	10
<b>915/3</b>	16	160	10

## Art. 916

## Kit puntali RAPIDO

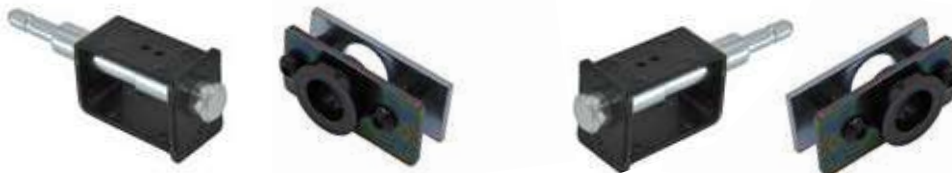

Materiale: Acciaio Inox

"RAPIDO" Ferrule kit

"RAPIDO" Ensemble de tringles

"RAPIDO" Kit de puntas

"RAPIDO" Kit von Zwingen

Art.	Ø	Tubolare	Peso(g)	Conf.
<b>916</b>	10	30x40	460	10
<b>916/1</b>	12	30x40	490	10
<b>916/2</b>	14	30x40	540	10
<b>916/3</b>	16	30x40	560	10

## Art. 917

## Coppia aste RAPIDO (puntale non incluso)

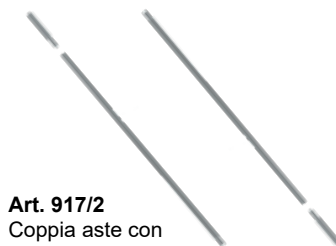
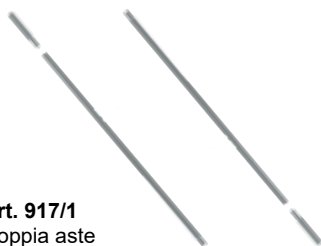

**Art. 917/1**  
Coppia aste

**Art. 917/2**  
Coppia aste con foro filettato

Materiale: Acciaio Inox

"RAPIDO" Pair of rods, ferrule not included

"RAPIDO" Paire de tringles, virole non incluse





"RAPIDO" Pareja de varillas, punta no incluida

"RAPIDO" Paar von Stangen, tipp nicht enthalten

Art.	Peso(g)
<b>917/1</b>	540
<b>917/2</b>	540

**Perno filettato per astina Ø 10 RAPIDO**

**Art. 918**

-  *Threaded pin for rod*
-  *Goupille filetée pour tige*
-  *Pasador roscado para varilla*
-  *Gewindestift für Stange*

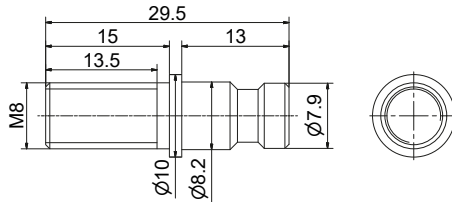

Materiale: Acciaio Zincato

Art.	Peso(g)	Conf.
918	12	200

**Perno per astina Ø 10 RAPIDO**

**Art. 919**

-  *Pin for rod*
-  *Goupille pour tige*
-  *Pasador para varilla*
-  *Stift für Stange*

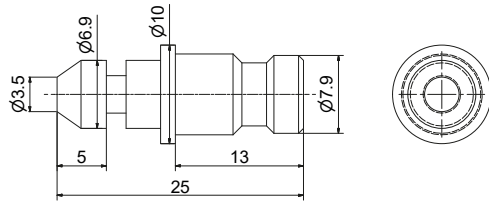

Materiale: Acciaio Zincato

Art.	Peso(g)	Conf.
919	12	200

**Puntale sfuso RAPIDO**

**Art. 920**

-  *Loose ferrule*
-  *Virole en vrac*
-  *Punta suelta*
-  *Losen Tipp*

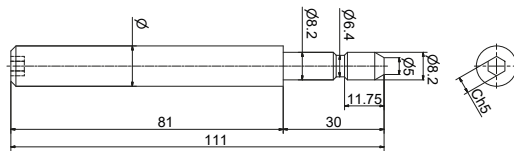





Materiale: Acciaio Zincato

Art.	Ø	Peso(g)	Conf.
920/1	10	70	10
920/2	12	100	10
920/3	14	140	10
920/4	16	180	10

**Snodo centrale a saldare zincato**

**Art. 905**

-  *Central galvanised steel articulated joint to be screwed or welded for tubular*
-  *Rotule centrale en acier zingué à visser ou à souder pour tubulaire*
-  *Junta central en acero cincado a atornillar o a soldar para tubular*
-  *Gelenk für Rechteckrohre zum Schweißen*

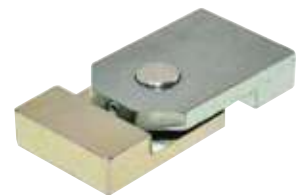
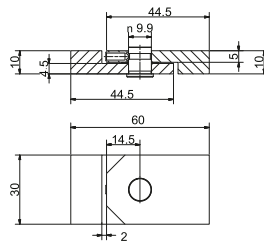





Materiale: Acciaio Zincato

Art.	Profilo	Peso(g)	Conf.
905	30x10	130	20

**Cerniera a tre ali per combinato**

**Art. 116 - 215**

-  *Three wing hinge to combined use*
-  *Charnière avec trois ailes pour usage combiné*
-  *Bisagra de tres alas para uso combinado*
-  *3-teilig Anschweißband für kombinierten Einsatz*

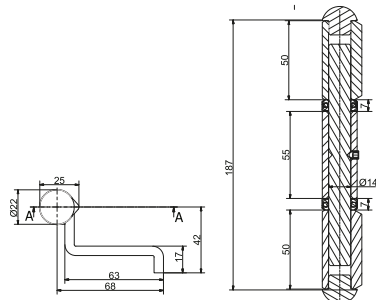

Materiale: Acciaio zincato

Art.	Finitura	Peso(g)	Conf.
215	grezza	720	6
116	zincata	720	6



**Caratteristiche tecniche snodi per grate**



**Perno di tenuta**

**Grano di fissaggio snodo**

**Viti di ancoraggio snodo al tubolare**



**Snodo superiore/inferiore chiuso**

**Viti di ancoraggio snodo al tubolare**

**Grano di fissaggio snodo**

**Perno di tenuta**

**Angolo di rifinitura centrale**  
(applicazione parte superiore)



l'angolo è predisposto per il passaggio puntale/asta comandato dalla serratura

**Angolo di rifinitura centrale**  
(applicazione parte inferiore)



l'angolo è predisposto per il passaggio puntale/asta comandato dalla serratura

**Angolo di rifinitura superiore**  
la rotazione avviene per mezzo di un perno che funziona da cardine. Il perno è già montato sulla piastra superiore.



**Viti di ancoraggio piastra superiore**  
per smontaggio grata di sicurezza

**Angolo di rifinitura inferiore**  
la rotazione avviene per mezzo di un perno che funziona da cardine. Il perno è già montato sulla piastra inferiore



**Snodo centrale Cerniera centrale laterale**  
per le porte è consigliato utilizzare lo snodo centrale abbinato alla cerniera centrale laterale



Scarica la brochure SNODI dal nostro sito web [www.novaferr.com](http://www.novaferr.com)

**Art. 897**

**Snodo superiore / inferiore ad avvitare o saldare zincato con perno**



Materiale: Acciaio zincato

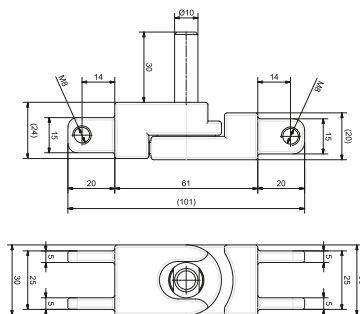

Upper/lower galvanised steel articulated joint to be screwed or welded for tubular

Rotule supérieure/inferieure en acier zingué à visser ou à souder pour tubulaire

Junta superior/inferior en acero cincado a tornillar o a soldar para tubular

Oberes/unteres verzinktes Gelenk mit Stift für Rechteckrohre, zum Schrauben oder Schweißen

Art.	Tubolare	Peso(g)	Conf.
897	30x20	340	4

**Art. 898**

**Snodo centrale ad avvitare o saldare zincato**



Materiale: Acciaio Zincato

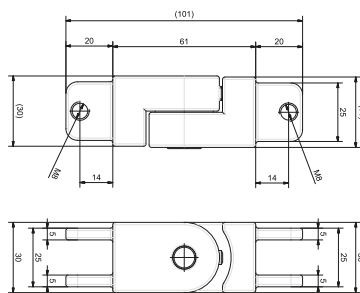

Central galvanised steel articulated joint to be screwed or welded for tubular

Rotule centrale en acier zingué à visser ou à souder pour tubulaire

Junta central en acero cincado a tornillar o a soldar para tubular

Zentrales verzinktes Gelenk für Vierkantrohre, zum Schrauben oder Schweißen

Art.	Tubolare	Peso(g)	Conf.
898	30x30	460	4

**Cerniera centrale-laterale ad avvitare o saldare**

**Art. 899**

Central transom galvanised steel hinge with side hook to be screwed or welded for tubular

Charnière traverse centrale crochet latéral en acier zingué à visser ou à souder pour tubulaire

Bisagra montante central gancho lateral en acero cincado a atornillar o a soldar para tubular

Zentral-seitliches Scharnier für Vierkantrohre, zum Schrauben oder Schweißen

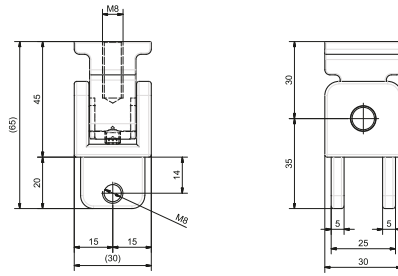

Materiale: Acciaio Zincato

Art.	Tubolare	Peso(g)	Conf.
899	30x30	260	4

**Angolo in acciaio zincato ad avvitare o saldare**

**Art. 901**

Galvanised steel angle to be screwed or welded for tubular

Coin en acier zingué à visser ou à souder pour tubulaire

Ángulo en acero cincado a atornillar o a soldar para tubular

Winkel aus verzinktem Stahl für Rechteckrohre, zum Schrauben oder Schweißen

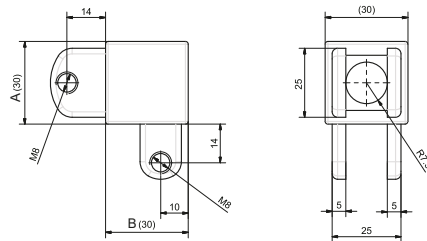

Materiale: Acciaio zincato

Art.	Tubolare A	Tubolare B	Peso(g)	Conf.
901	30x30	30x30 max	200	8

**Angolo in acciaio zincato ad avvitare o saldare**

**Art. 902**

Galvanised steel angle to be screwed or welded for tubular

Coin en acier zingué à visser ou à souder pour tubulaire

Ángulo en acero cincado a atornillar o a soldar para tubular

Winkel aus verzinktem Stahl für Rechteckrohre, zum Schrauben oder Schweißen

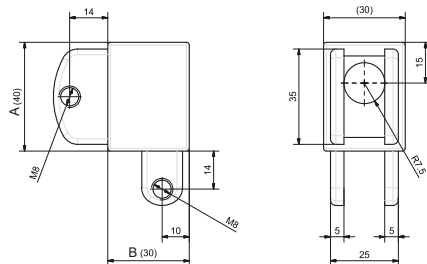

Materiale: Acciaio zincato

Art.	Tubolare A	Tubolare B	Peso(g)	Conf.
902	30x40	30x30 max	250	8

**Cerniera superiore con boccola di frizionamento**

**Art. 903**

Galvanised steel upper hinge with frictioning bushing

Charnière supérieure en acier zingué avec douille de friction

Bisagra superior en acero cincado con buje de fricción

Oberes Scharnier mit Reibungsbuchse

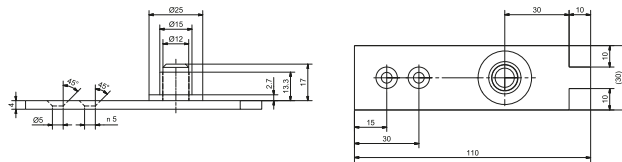

Materiale: Acciaio zincato

Art.	Peso(g)	Conf.
903	100	8

**Cerniera inferiore con boccola di frizionamento**

**Art. 904**

Galvanized steel lower hinge with frictioning bushing

Charnière inférieure en acier zingué avec douille de friction

Bisagra inferior en acero cincado con buje de fricción

Unteres Scharnier mit Reibungsbuchse

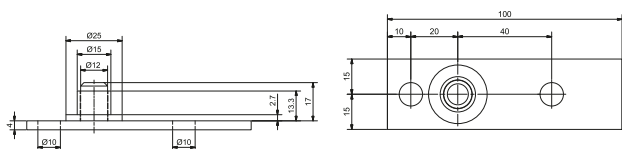

Materiale: Acciaio zincato

Art.	Peso(g)	Conf.
904	100	8

## SISTEMA A SALDARE

### ART. 133 CERNIERA A SCOMPARSA INOX AISI 304

#### Cerniera a scomparsa ribaltamento 90°



TESTED



**Unica**  
Brevettata  
Patented

Materiale: Acciaio inox AISI304

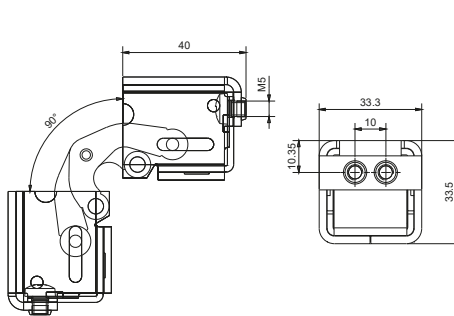

Internal hinge with 90° tilting

Charnière interne avec renversement 90°

Bisagra interna apertura a 90°

Verdecktürband um 90° Umklippung

Art.	A	B	Tubolare	Portata	Peso(g)	Conf.
133/1.2	33,5	40	40x40	160Kg la coppia	350	8

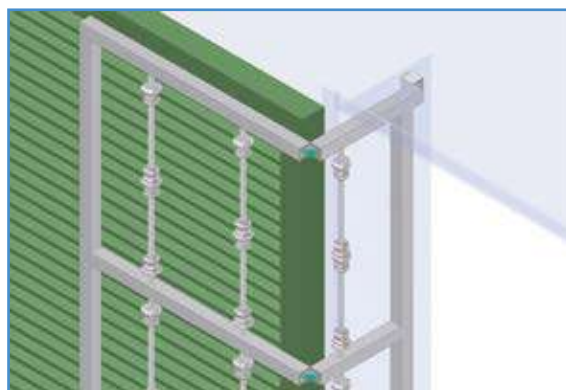

#### Cerniera a scomparsa ribaltamento 180°



TESTED



**Unica**  
Brevettata  
Patented

Materiale: Acciaio inox AISI304

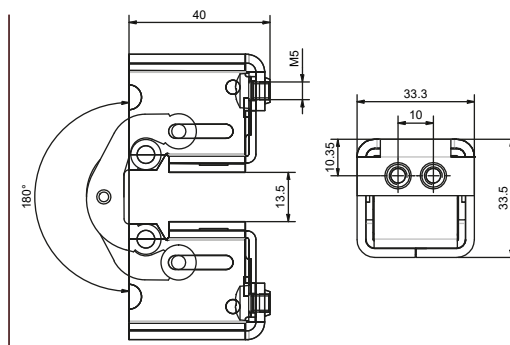

Internal hinge with 180° tilting

Charnière interne avec renversement 180°

Bisagra interna apertura a 180°

Verdecktürband um 180° Umklippung



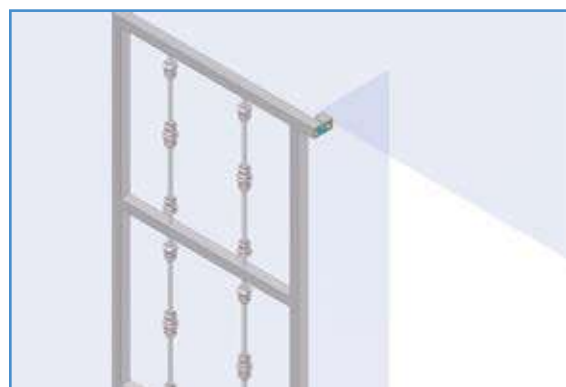
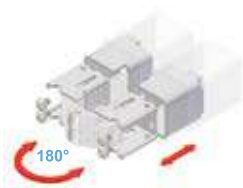

Art.	Tubolare	Portata	Peso(g)	Conf.
133/2.2	40x40	160Kg la coppia	350	8



SISTEMA AD AVVITARE

ART. 133 CERNIERA A SCOMPARSA INOX AISI 304

Cerniera a scomparsa per profili complanari in ferro

-  *Hidden hinge for steel complanar molded case*
-  *Charnières escamotable pour caisson en fer coplanaires*
-  *Bisagra oculta para cajas moldeadas coplanares de hierro*
-  *Verdeckter Reißverschluss für Faltschachteln aus Eisen*

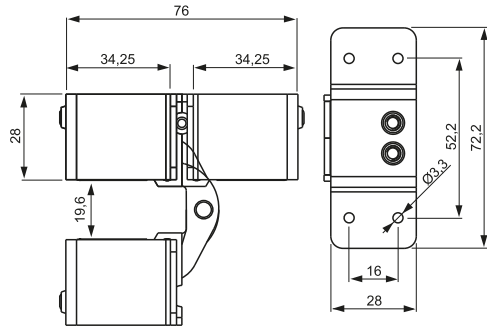





**Unica**  
Brevettata  
Patented  
ITC  
TESTED

Materiale: Acciaio Inox AISI304

Art.	Apertura	Portata	Peso(g)	Conf.
133/1.2.3	90°	160Kg la coppia	310	8
133/2.2.3	180°	160Kg la coppia	310	8

Cerniera asimmetrica a scomparsa per profili complanari in ferro

-  *Hidden asymmetric hinge for steel complanar molded case*
-  *charnière asymétrique escamotable pour profilés coplanaires en fer*
-  *Bisagra oculta asimétrica para perfiles planos de hierro*
-  *Verdecktes asymmetrisches Scharnier für Verbundprofile aus Eisen*

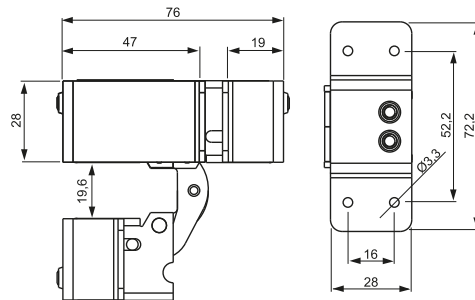





**Unica**  
Brevettata  
Patented  
ITC  
TESTED

Materiale: Acciaio Inox AISI304

Art.	Apertura	Portata	Peso(g)	Conf.
133/1.2.4	90°	160Kg la coppia	310	8
133/2.2.4	180°	160Kg la coppia	310	8

Spessore per cerniera a scomparsa

Art. 133

-  *Thickness for hidden hinge*
-  *Épaisseur pour charnière cachée*
-  *Espesor para bisagra oculta*
-  *Dicke für verstecktes Scharnier*

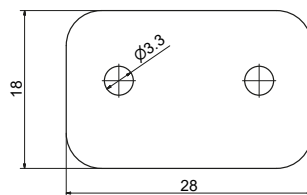

Materiale: Nylon

Art.	Spessore(mm)	Peso(g)
133	1	0,6

Dimensioni scasso su profili

Esempio

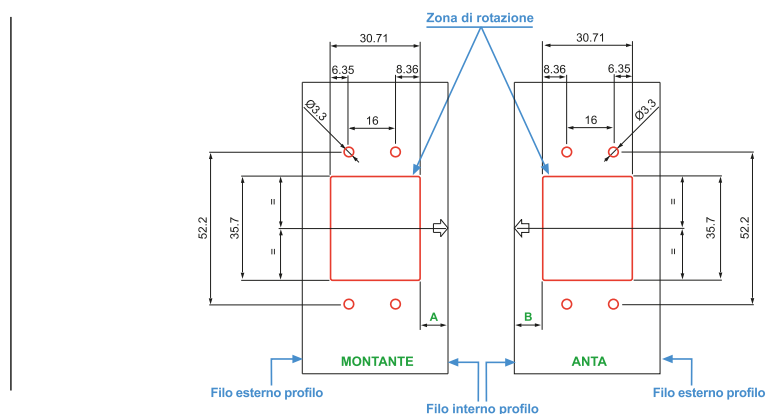
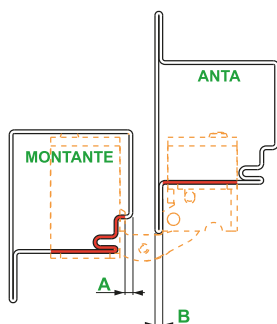

 In rosso i fori e gli scassi da fare sul profilo  
**A-B** In base alla tipologia di profilo richiedici la dimensione delle due quote A+B

## Art. 320 - 321

## Compensatore ornamentale tornito Ø30-36

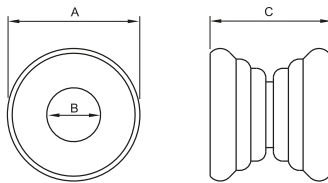

- Turned ornamental corrector Ø30-36
- Dispositif correcteur ornamental Ø30-36
- Compensador ornamental torneado Ø30-36
- Dekor-Kompensator, gedreht Ø 30 - 36

Materiale: Acciaio grezzo / Acciaio zincato

Art.	A	B	C	Finitura	Peso(g)	Conf.
320/1	30	12,5	32 - 40	grezzo	90	50
320/2	36	14,5	32 - 40	grezzo	130	50
320/1.76	30	12,5	32 - 40	zincato	90	50
320/2.76	36	14,5	32 - 40	zincato	130	50
321/1	30	12,5	50 - 60	grezzo	100	50
321/2	36	14,5	50 - 60	grezzo	140	50
321/1.76	30	12,5	50 - 60	zincato	100	50
321/2.76	36	14,5	50 - 60	zincato	140	50



## Art. 330

## Compensatore

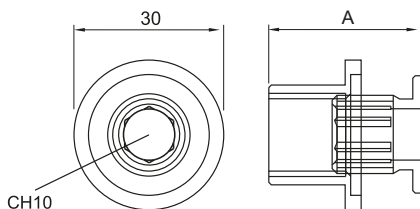

- Turned ornamental corrector
- Dispositif correcteur ornamental
- Compensador ornamental torneado
- Dekor-Kompensator, gedreht

Materiale: Acciaio zincato

Art.	A	Peso(g)	Conf.
330/1	18 - 30	45,27	100
330/2	30 - 52	69	100

## Art. 123

## Paletto ad incasso singola azione, filetto 8MA

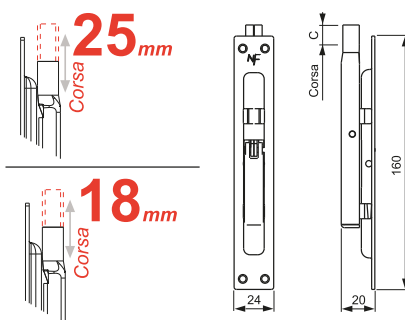

- Bolt to be recessed thread 8MA
- Verrou à enchasser filet 8MA
- Pestillo a encaje rosca 8MA
- Einsteck-Türkantenriegel mit Kipphebel und Gewinde 8MA. Einzelbewegung

Materiale: Acciaio zincato

Art.	Leva	Frontale	C	Peso(g)	Conf.
123.1.25	ferro	zincato	25	140	12
123.3.25	ottone	zincato	25	140	12
123.1.25.90	ferro	vr.nero	25	150	12
123.1.18	ferro	zincato	18	140	12
123.3.18	ottone	zincato	18	150	12
123.3/1.18	lamiera ott.	zincato	18	150	12

## Art. 128

## Paletto ad incasso doppia azione, filetto 8MA

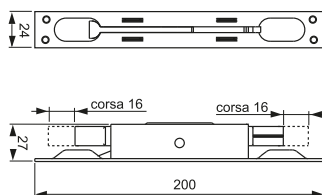

- Double lever action gripping to be enclosed, thread 8MA
- Verrou à enchasser à double action, filet 8MA
- Pestillo a encaje con doble acción, rosca 8MA
- Einsteck-Türkantenriegel mit Kipphebel und Gewinde 8MA. Doppelbewegung

Materiale: Acciaio zincato

Art.	Leva	Peso(g)	Conf.
128	ottone	270	15

Contropiastra per serratura da fascia doppia mappa con catenaccio e scrocco

Art. 0053

Striking plates for locks

Contre-plaque pour serrures

Cerradero para cerraduras

Gegenplatte für Doppel-Bit Schloss mit Kantenriegel

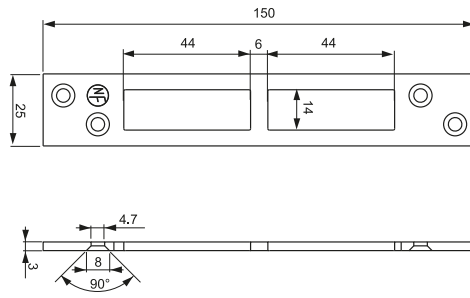

**Kassel**



Materiale: Acciaio Zincato

Art.	Peso(g)	Conf.
0053	50	100

Contropiastra per serratura da fascia catenaccio rettangolare

Art. 0054

Striking plates for locks

Contre-plaque pour serrures

Cerradero para cerraduras

Gegenplatte für Schloss mit Rechteckigem Kantenriegel

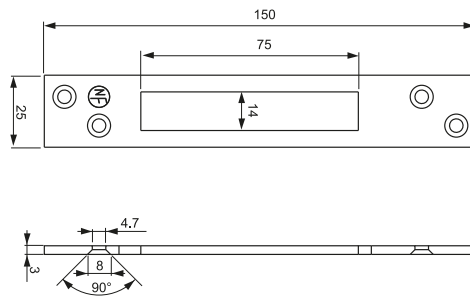

**Kassel**



Materiale: Acciaio Zincato

Art.	Peso(g)	Imb.
0054	60	100

Contropiastra per montante a cilindro profilo europeo per serrature a gancio e scrocco

Art. 0055

Striking plates for locks

Contre-plaque pour serrures

Cerradero para cerraduras

Gegenplatte für Zylinder Einsteckschloss mit Haken und Riegel

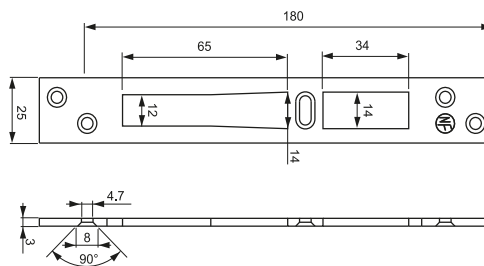

**Kassel**



Materiale: Acciaio Zincato

Art.	Peso(g)	Imb.
0055	70	100

Contropiastra per montante per serratura a gancio

Art. 0056

Striking plates for locks

Contre-plaque pour serrures

Cerradero para cerraduras

Gegenplatte für Schloss mit Rechteckigem Kantenriegel

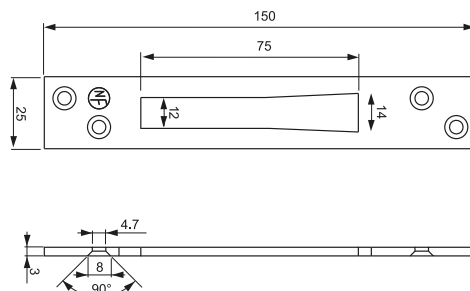

**Kassel**



Materiale: Acciaio Zincato

Art.	Peso(g)	Imb.
0056	60	100





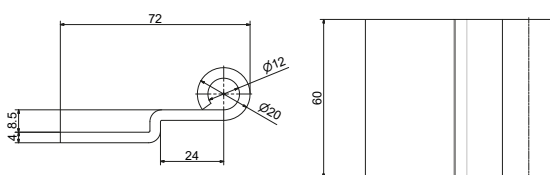

## CREA LA TUA CERNIERA PER COMBINATO

Art. 5147

Ala cerniera telaio



-  Hinge for security grille
-  Charnière pour grille de sécurité
-  Bisagra para rejilla de seguridad
-  Scharnier für Sicherheitsgitter





Materiale: Acciaio Zincato

Art.	Peso(g)	Conf.
5147	210	50

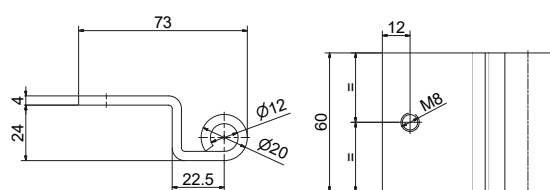
Art. 5148

Ala cerniera anta



-  Hinge for security grille
-  Charnière pour grille de sécurité
-  Bisagra para rejilla de seguridad
-  Scharnier für Sicherheitsgitter





Materiale: Acciaio Zincato

Art.	Peso(g)	Conf.
5148	250	50

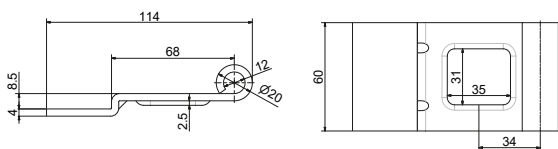
Art. 5151

Ala cerniera con sbraccio



-  Hinge for security grille
-  Charnière pour grille de sécurité
-  Bisagra para rejilla de seguridad
-  Scharnier für Sicherheitsgitter





Materiale: Acciaio Zincato

Art.	Peso(g)	Conf.
5151	290	50

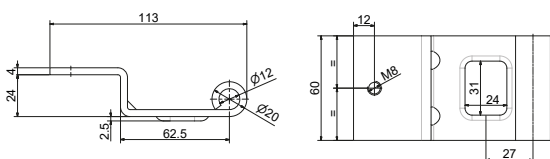
Art. 5150

Ala cerniera con sbraccio terza anta



-  Hinge for security grille
-  Charnière pour grille de sécurité
-  Bisagra para rejilla de seguridad
-  Scharnier für Sicherheitsgitter





Materiale: Acciaio Zincato

Art.	Peso(g)	Conf.
5150	310	50

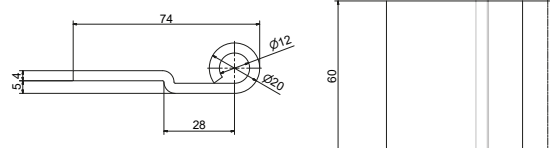
Art. 5203

Ala cerniera







-  Hinge for security grille
-  Charnière pour grille de sécurité
-  Bisagra para rejilla de seguridad
-  Scharnier für Sicherheitsgitter

Materiale: Acciaio Zincato

Art.	Peso(g)	Conf.
5203	210	50

**Ala cerniera per anta persiana** Art. 5152



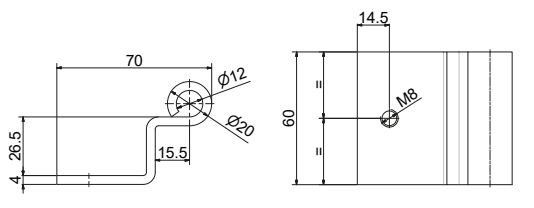

-  Hinge for security grille
-  Charnière pour grille de sécurité
-  Bisagra para rejilla de seguridad
-  Scharnier für Sicherheitsgitter



Materiale: Acciaio Zincato

Art.	Peso(g)	Conf.
5152	240	50

**Ala cerniera terza anta** Art. 5149



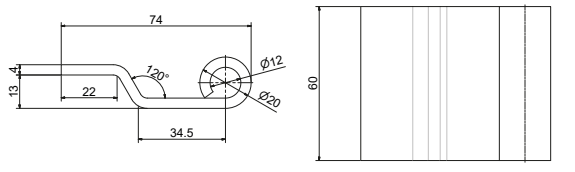

-  Hinge for security grille
-  Charnière pour grille de sécurité
-  Bisagra para rejilla de seguridad
-  Scharnier für Sicherheitsgitter



Materiale: Acciaio Zincato

Art.	Peso(g)	Conf.
5149	215	50

**Ala cerniera telaio PEG** Art. 5153



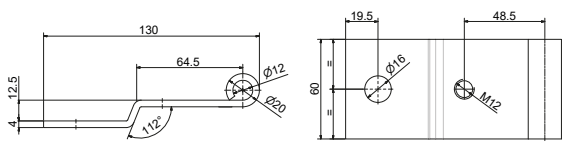

-  Hinge for security grille
-  Charnière pour grille de sécurité
-  Bisagra para rejilla de seguridad
-  Scharnier für Sicherheitsgitter



Materiale: Acciaio Zincato

Art.	Peso(g)	Conf.
5153	330	50

**Ala cerniera anta PEG** Art. 5154



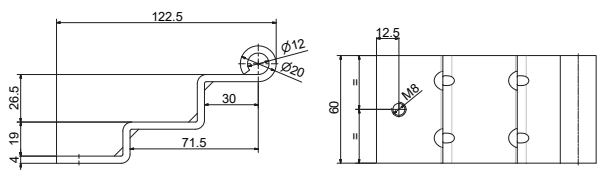

-  Hinge for security grille
-  Charnière pour grille de sécurité
-  Bisagra para rejilla de seguridad
-  Scharnier für Sicherheitsgitter



Materiale: Acciaio Zincato

Art.	Peso(g)	Conf.
5154	350	50

**Ala cerniera** Art. 5204

-  Hinge for security grille
-  Charnière pour grille de sécurité
-  Bisagra para rejilla de seguridad
-  Scharnier für Sicherheitsgitter

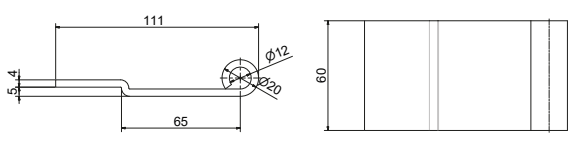

Materiale: Acciaio Zincato

Art.	Peso(g)	Conf.
5204	300	50

### CILINDRI / CYLINDERS

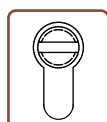

Predisposizione per cilindro europeo

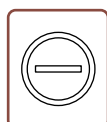

Cilindro tondo (chiave reversibile)

Con doppio cilindro

Con pomolo

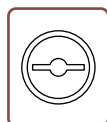

Cilindro a doppia mappa

### CHIAVI / KEYS

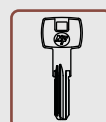

Chiave reversibile



Chiave a pettine

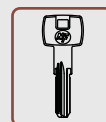

Chiave reversibile

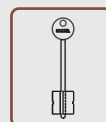

Chiave a doppia mappa

### CILINDRI / CYLINDERS

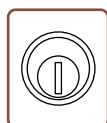

Cilindro tondo



Cilindro a doppia mappa

### CHIAVI / KEYS



Chiave a pettine



Chiave a doppia mappa corta

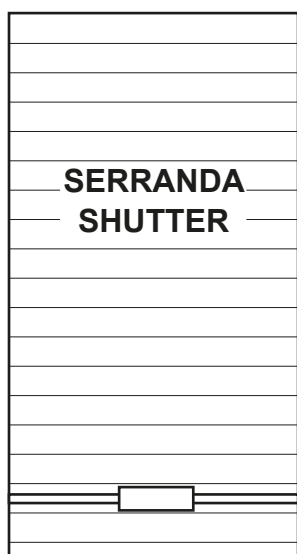
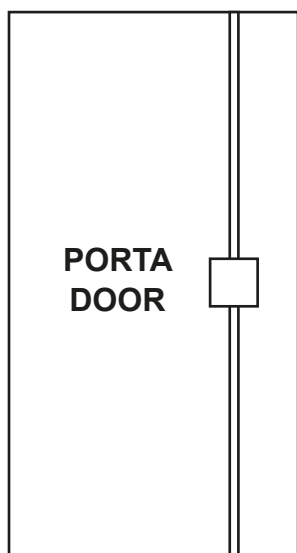

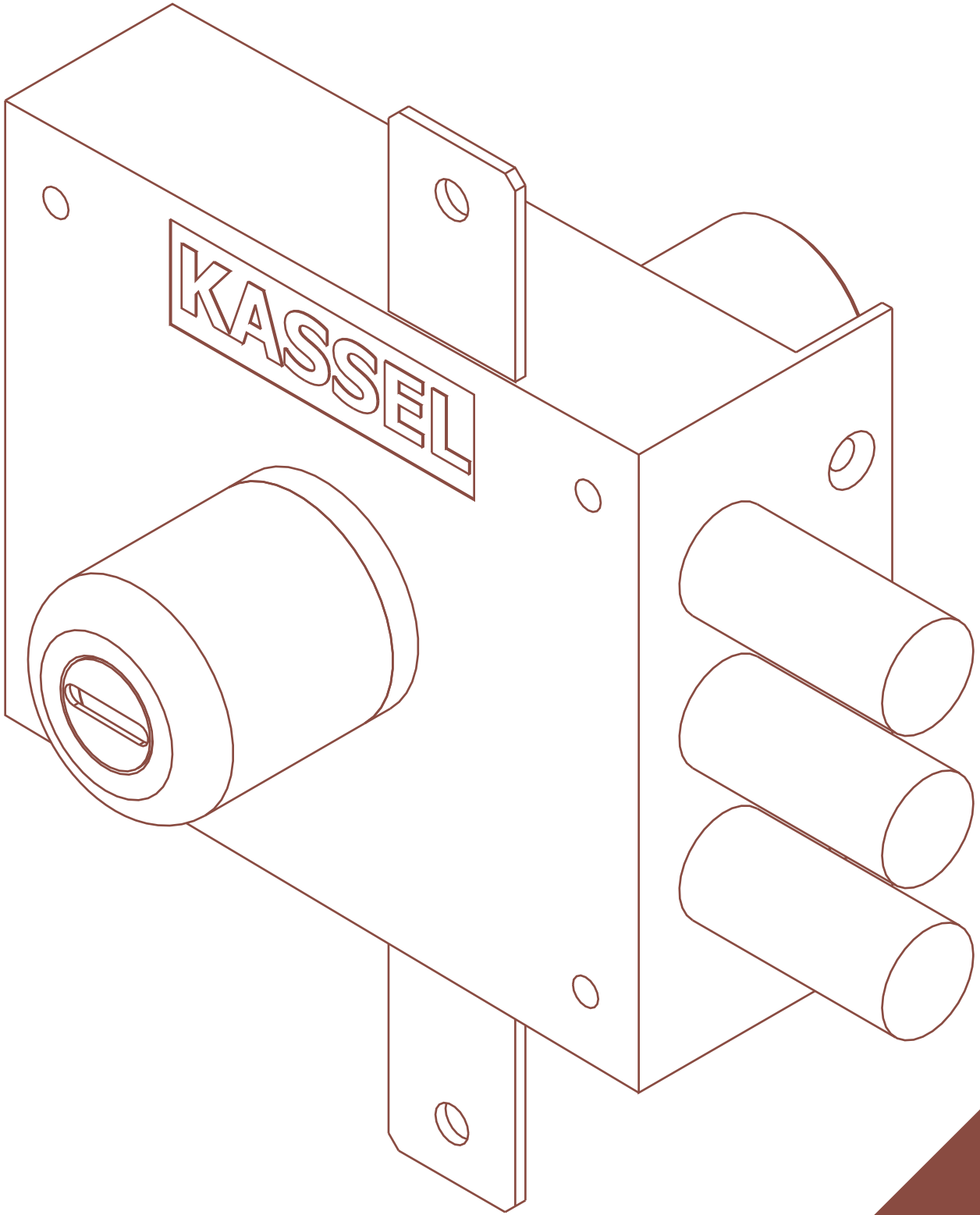

# SERRATURE

Locks - Serrures - Cerraduras - Schlösser

CATALOGO  
N.25

## TIPOLOGIA: SERRATURE PREDISPOSTE PER CILINDRO EUROPEO TYPE: LOCKS FOR EUROPEAN CYLINDER

### Art. 4101/CE - 4102/CE

### Serratura laterale senza scrocco

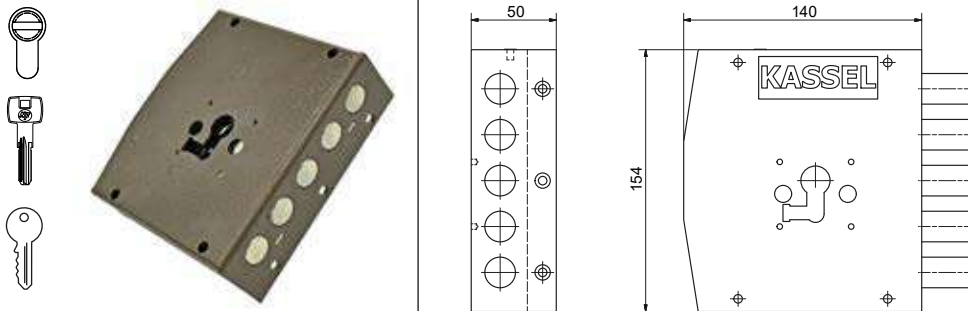

Materiale: Acciaio verniciato

Side lock without latchbolt

Serrure latérale sans demi-tour

Cerradura lateral sin resbalón

Seitenschloss ohne Falle

Art.	Mano	Ingombro	Peso(g)	Imb.
4101/CE	DX	140x154x33	2.140	12 pz.
4102/CE	SX	140x154x33	2.140	12 pz.

**Kassel**

### Art. 4151/CE - 4152/CE

### Serratura laterale con scrocco

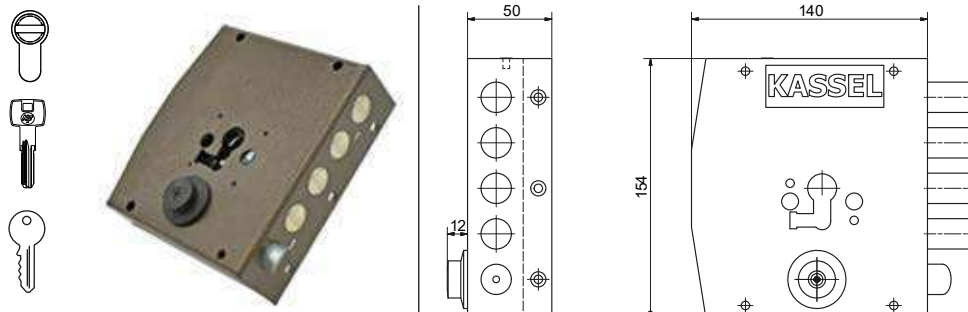

Materiale: Acciaio verniciato

Side lock with latchbolt

Serrure latérale avec demi-tour

Cerradura lateral con resbalón

Dreifachschloss ohne Falle

Art.	Mano	Ingombro	Peso(g)	Imb.
4151/CE	DX	140x154x33	2.090	12 pz.
4152/CE	SX	140x154x33	2.090	12 pz.

**Kassel**

### Art. 4301/CE - 4302/CE

### Serratura triplice senza scrocco

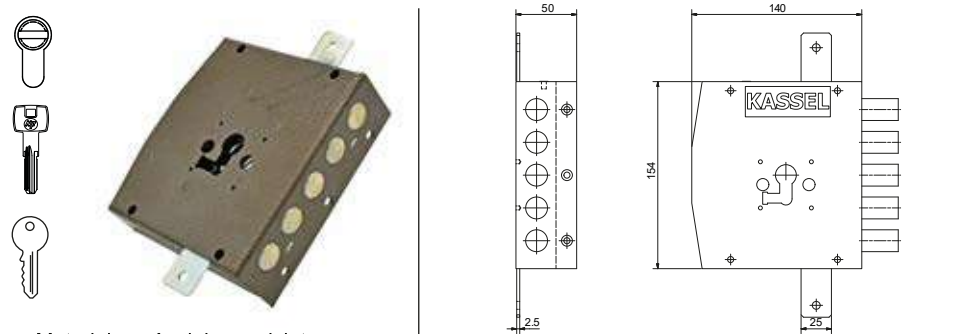

Materiale: Acciaio verniciato

Three-point lock without latchbolt

Serrure 3 points sans demi-tour

Cerradura triple sin resbalón

Dreifachschloss ohne Falle

Art.	Mano	Ingombro	Var.	Peso(g)	Imb.
4301/CE	DX	140x154x33	Con aste	3.760	12 pz.
4302/CE	SX	140x154x33	Con aste	3.760	12 pz.
4301SA/CE	DX	140x154x33	Senza aste	2.260	12 pz.
4302SA/CE	SX	140x154x33	Senza aste	2.260	12 pz.

**Kassel**

Serratura con coppia di spostamenti inclusi Art. 0604

## Serratura tripla con scrocco

Art. 4351/CE - 4352/CE

Three-point lock with latchbolt

Serrure 3 points à 4 pènes latéraux avec demi-tour

Cerradura triple y resbalón

Dreifach-Türschloss mit doppel Zylinder und Falle.

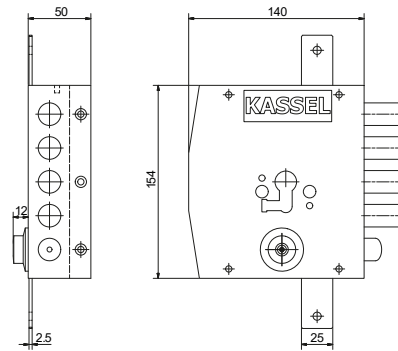

Materiale: Acciaio verniciato

**Kassel**

Serratura con coppia di spostamenti inclusi Art. 0604

Art.	Mano	Ingombro	Var.	Peso(g)	Imb.
4351/CE	DX	140x154x33	Con aste	3.710	12 pz.
4352/CE	SX	140x154x33	Con aste	3.710	12 pz.
4351SA/CE	DX	140x154x33	Senza aste	2.210	12 pz.
4352SA/CE	SX	140x154x33	Senza aste	2.210	12 pz.

## Serratura quintupla con deviatore, senza scrocco

Art. 4501/CE - 4502/CE

Five-point lock for double cylinder, without latchbolt and with switch box

Serrure 5 points en applique à double-cylindre sans demi-tour, avec appareil de deviaton

Cerradura quintuple de sobreponer por cilindro doble, sin resbalón, con resviador

Fünffach-Schloss ohne Falle und Umlenker

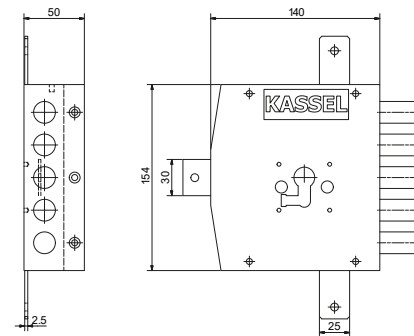

Materiale: Acciaio verniciato

**Kassel**

Serratura con coppia di spostamenti inclusi Art. 0604

Art.	Mano	Ingombro	Var.	Peso(g)	Imb.
4501/CE	DX	140x154x33	Con aste	6.000	12 pz.
4502/CE	SX	140x154x33	Con aste	6.000	12 pz.
4501SA/CE	DX	140x154x33	Senza aste	2.800	12 pz.
4502SA/CE	SX	140x154x33	Senza aste	2.800	12 pz.

## Serratura quintupla con deviatore, con scrocco

Art. 4551/CE - 4552/CE

Five-point lock with latchbolt and switch box

Serrure 5 points avec demi-tour et appareil de deviaton

Cerradura quintuple con resablon y resviador

Fünffach-Schloss mit Falle und Umlenkung

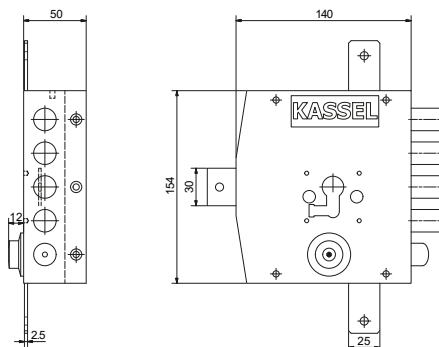

Materiale: Acciaio verniciato

**Kassel**

Serratura con coppia di spostamenti inclusi Art. 0604

Art.	Mano	Ingombro	Var.	Peso(g)	Imb.
4551/CE	DX	140x154x33	Con aste	5.950	12 pz.
4552/CE	SX	140x154x33	Con aste	5.950	12 pz.
4551SA/CE	DX	140x154x33	Senza aste	2.750	12 pz.
4552SA/CE	SX	140x154x33	Senza aste	2.750	12 pz.

## TIPOLOGIA: CILINDRO TONDO, CHIAVE REVERSIBILE CON POMOLO INTERNO TYPE: ROUND CYLINDER, REVERSIBLE KEY WITH INSIDE KNOB

Art. 2010/CP

Serratura laterale ambidestra

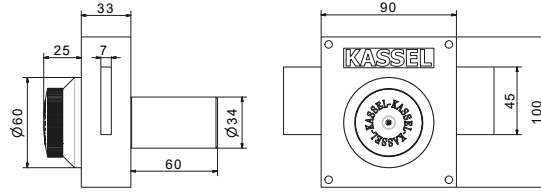
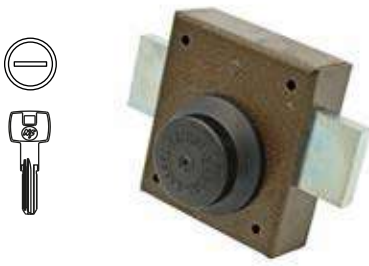

- Ambidextrous cylinder lock*
- Serrure latérale ambidextre*
- Cerradura lateral ambidestra*
- Beidhändig Türschloss*

Materiale: Acciaio verniciato

Art.	Ingombro	Peso(g)	lmb.
2010/CP	90X100X33	1.300	16



Art. 2001/CP - 2002 /CP

Serratura laterale senza scrocco

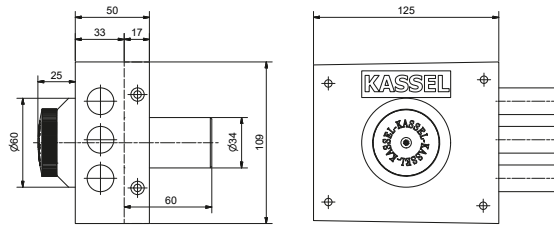

- Side cylinder lock without spring latch*
- Serrure latérale sans ressort*
- Cerradura lateral sin resbalón*
- Fallenloses Seitenschloss*

Materiale: Acciaio verniciato

Art.	Mano	Ingombro	Peso(g)	lmb.
2001/CP	DX	125X105X33	1.100	16
2002/CP	SX	125X105X33	1.100	16



Art. 2101/CP - 2102/CP

Serratura laterale senza scrocco

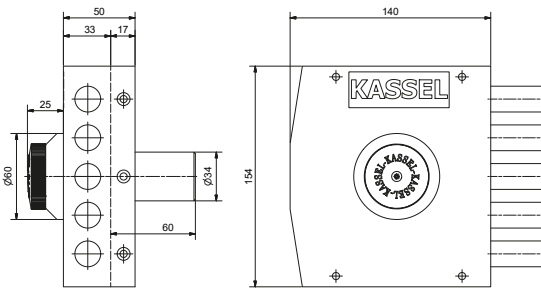

- Side cylinder lock without spring latch*
- Serrure latérale sans ressort*
- Cerradura lateral sin resbalón*
- Fallenloses Seitenschloss*

Materiale: Acciaio verniciato

Art.	Mano	Ingombro	Peso(g)	lmb.
2101/CP	DX	140X154X33	2.470	12
2102/CP	SX	140X154X33	2.470	12



Art. 2151/CP - 2152 /CP

Serratura laterale con scrocco

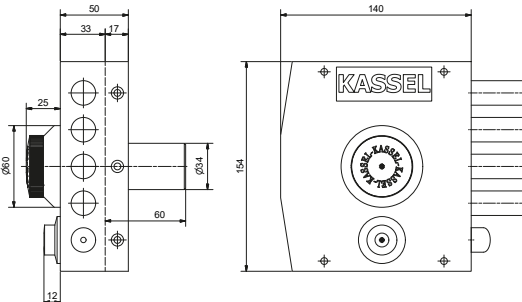

- Side cylinder lock with spring latch*
- Serrure latérale avec ressort*
- Cerradura lateral con resbalón*
- Seitenschloss mit Riegel*

Materiale: Acciaio verniciato

Art.	Mano	Ingombro	Peso(g)	lmb.
2151/CP	DX	140X154X33	2.420	12
2152/CP	SX	140X154X33	2.420	12



## Serratura triplice senza scrocco

Art. 2201/CP - 2202/CP

Three points lock without spring latch

Serrure à trois points sans ressort

Cerradura triple sin resbalón

Dreifachschloss ohne Riegel

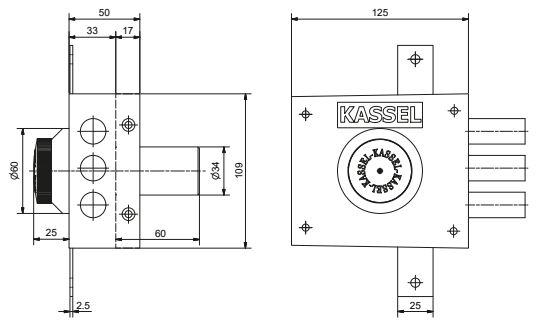

Materiale: Acciaio verniciato

**Kassel**

Serratura con coppia di spostamenti inclusi Art. 0604

Art.	Mano	Ingombro	Var.	Peso(g)	Imb.
2201/CP	DX	125X105X33	con aste	2.650	16
2202/CP	SX	125X105X33	con aste	2.650	16
2201SA/CP	DX	125X105X33	senza aste	1.150	16
2202SA/CP	SX	125X105X33	senza aste	1.150	16

## Serratura triplice senza scrocco

Art. 2301/CP - 2302/CP

Three points lock without spring latch

Serrure à trois points sans ressort

Cerradura triple sin resbalón

Dreifachschloss ohne Riegel

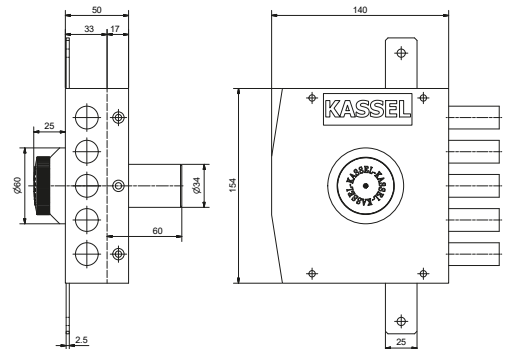

Materiale: Acciaio verniciato

**Kassel**

Serratura con coppia di spostamenti inclusi Art. 0604

Art.	Mano	Ingombro	Var.	Peso(g)	Imb.
2301/CP	DX	140X154X33	con aste	4.090	12
2302/CP	SX	140X154X33	con aste	4.090	12
2301SA/CP	DX	140X154X33	senza aste	2.590	12
2302SA/CP	SX	140X154X33	senza aste	2.590	12

## Serratura triplice con scrocco

Art. 2351/CP - 2352/CP

Three points lock with spring latch

Serrure à trois points avec ressort

Cerradura triple con resbalón

Dreifaches Schloss mit Falle

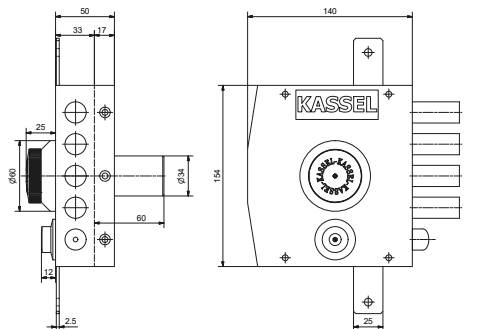

Materiale: Acciaio verniciato

**Kassel**

Serratura con coppia di spostamenti inclusi Art. 0604

Art.	Mano	Ingombro	Var.	Peso(g)	Imb.
2351/CP	DX	140X154X33	con aste	4.040	12
2352/CP	SX	140X154X33	con aste	4.040	12
2351SA/CP	DX	140X154X33	senza aste	2.540	12
2352SA/CP	SX	140X154X33	senza aste	2.540	12



## Art. 2501/CP - 2502/CP

## Serratura quintupla con deviatore, senza scrocco

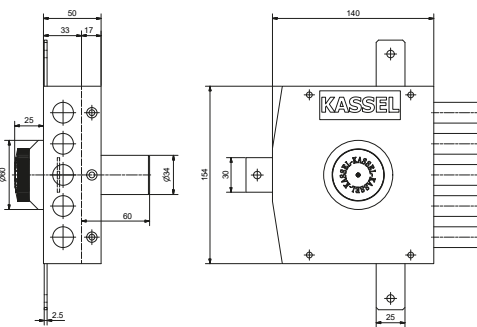
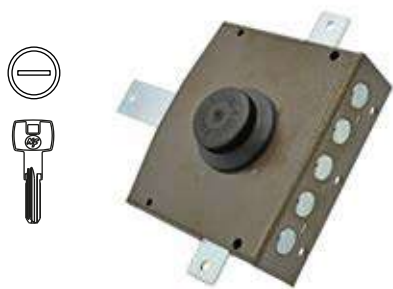

Five points side cylinder lock without spring latch with switch box

Serrure à cinq points sans ressort avec appareil de déviation

Cerradura quintuple sin resbalón desviador incluido

Fünffachverriegelung ohne Riegel, einschließlich Umlenkung

Materiale: Acciaio verniciato

Art.	Mano	Ingombro	Var.	Peso(g)	lmb.
2501/CP	DX	140X154X33	con aste	6.330	12
2502/CP	SX	140X154X33	con aste	6.330	12
2501SA/CP	DX	140X154X33	senza aste	3.130	12
2502SA/CP	SX	140X154X33	senza aste	3.130	12

**Kassel**

Serratura con coppia di spostamenti inclusi Art. 0604

## Art. 2551/CP - 2552/CP

## Serratura quintupla con deviatore, con scrocco

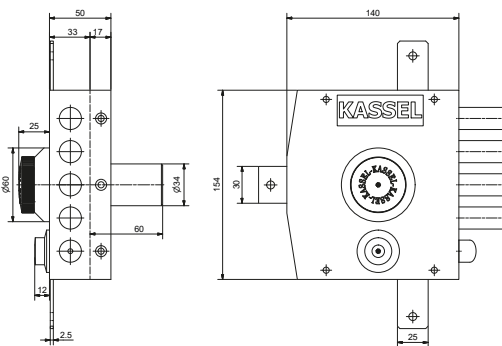
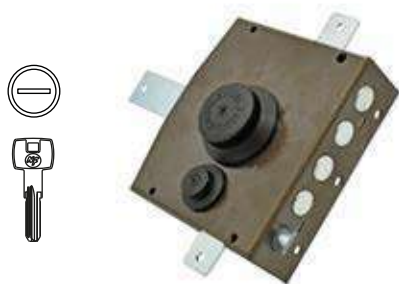

Five points side cylinder lock with spring latch with switch box

Serrure à cinq points avec ressort et appareil de déviation

Cerradura quintuple con resbalón desviador incluido

Fünffachverriegelung mit Riegel, einschließlich Umlenkung

Materiale: Acciaio verniciato

Art.	Mano	Ingombro	Var.	Peso(g)	lmb.
2551/CP	DX	140X154X33	con aste	6.280	12
2552/CP	SX	140X154X33	con aste	6.280	12
2551SA/CP	DX	140X154X33	senza aste	3.080	12
2552SA/CP	SX	140X154X33	senza aste	3.080	12

**Kassel**

Serratura con coppia di spostamenti inclusi Art. 0604

## Art. 6002 /CP

## Serratura per basculante a 4 chiusure verticali, predisposta per altre due chiusure supplementari orizzontali. Apertura interna con pomolo

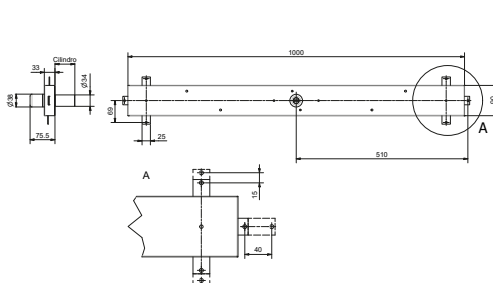

Overhead door lock with 4 vertical locks, prepared for two additional horizontal locks. Internal opening with knob

Serrure pour porte de garage avec cylindre à clé plate, 4 fermetures verticales, prévue pour 2 fermetures horizontales supplémentaires. Ouverture interne avec bouton

Cerradura para porton basculante con llave plana con 4 puntos de cierre verticales, preparada para dos puntos de cierre horizontales. Apertura interna con pomo

Zylinderschloss mit Flachschlüssel mit 4 senkrechten Verriegelungspunkten, vorbereitet für zwei weitere horizontale Verschlüsse. Innenöffnung mit Knopf

Materiale: Acciaio Verniciato

Art.	Var.	Apertura Interna	Cilindro	Peso(g)	Conf.
6002/6/CP	Con aste 6010	Pomolo	60	6.550	1
6002/7/CP	Con aste 6010	Pomolo	70	6.550	1
6002/6SA/CP	Senza Aste	Pomolo	60	3.950	1
6002/7SA/CP	Senza Aste	Pomolo	70	3.950	1





**Kassel**

Serratura con coppia di spostamenti inclusi Art. 0604

## TIPOLOGIA: CILINDRO TONDO, CHIAVE REVERSIBILE E DOPPIO CILINDRO TYPE: ROUND CYLINDER, REVERSIBLE KEY AND DOUBLE CYLINDER

### Serratura laterale ambidestra

Art. 4010/CP

-  *Ambidextrous side lock*
-  *Serrure latérale ambidextre*
-  *Cerradura lateral ambidestra*
-  *Beidhändiges Seitenschloss*

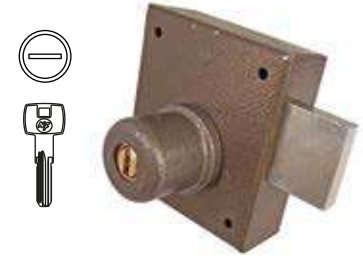
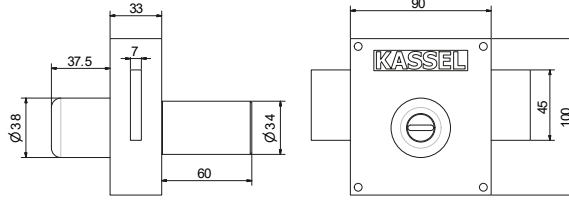





Materiale: Acciaio verniciato

**Kassel**

Art.	Ingombro	Peso(g)	Imb.
4010/CP	90X100X33	1.520	16

### Serratura laterale senza scrocco

Art. 4001/CP - 4002/CP

-  *Side lock without spring latch*
-  *Serrure latérale sans ressort*
-  *Cerradura lateral sin resbalón*
-  *Fallenloses Seitenschloss*

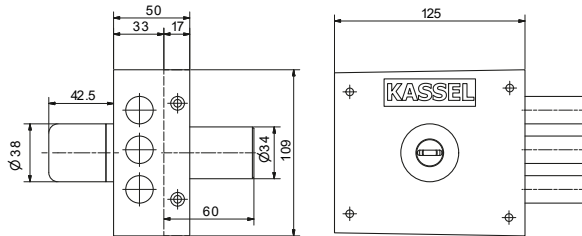





Materiale: Acciaio verniciato

**Kassel**

Art.	Mano	Ingombro	Peso(g)	Imb.
4001/CP	DX	125X105X33	1.320	16
4002/CP	SX	125X105X33	1.320	16

### Serratura laterale senza scrocco

Art. 4101/CP - 4102/CP

-  *Side lock without spring latch*
-  *Serrure latérale sans ressort*
-  *Cerradura lateral sin resbalón*
-  *Fallenloses Seitenschloss*

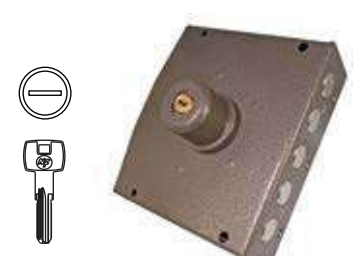
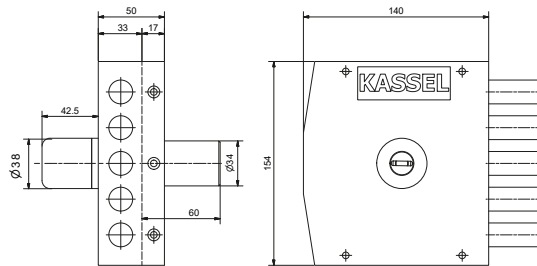





Materiale: Acciaio verniciato

**Kassel**

Art.	Mano	Ingombro	Peso(g)	Imb.
4101/CP	DX	140X154X33	2.760	12
4102/CP	SX	140X154X33	2.760	12

### Serratura laterale con scrocco

Art. 4151/CP - 4152/CP

-  *Side lock with spring latch*
-  *Serrure latérale avec ressort*
-  *Cerradura lateral con resbalón*
-  *Seitenschloss mit Riegel*

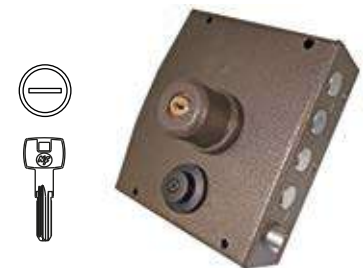
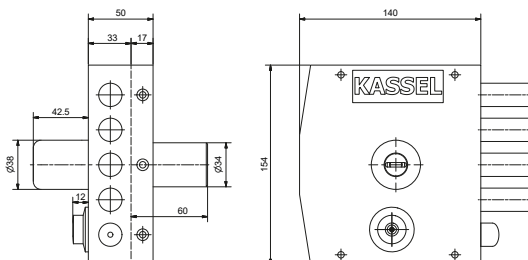

Materiale: Acciaio verniciato

**Kassel**

Art.	Mano	Ingombro	Peso(g)	Imb.
4151/CP	DX	140X154X33	2.710	12
4152/CP	SX	140X154X33	2.710	12

## Art. 4201/CP - 4202/CP

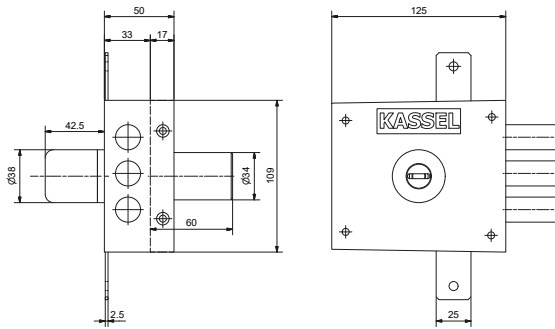
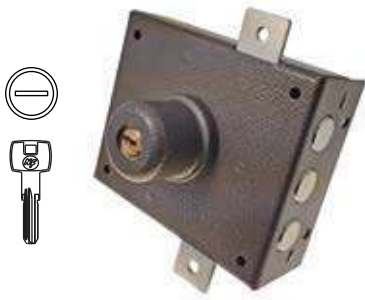

Materiale: Acciaio verniciato

Art.	Mano	Ingombro	Var.	Peso(g)	lmb.
4201/CP	DX	125X105X33	con aste	2.640	16
4202/CP	SX	125X105X33	con aste	2.640	16
4201 SA/CP	DX	125X105X33	senza aste	1.440	16
4202 SA/CP	SX	125X105X33	senza aste	1.440	16

## Serratura triplice senza scrocco

Three points lock without spring latch

Serrure à trois points sans ressort

Cerradura triple sin resbalón

Dreifachschloss ohne Riegel

**Kassel**

Serratura con Art. 0604  
Coppia spostamenti inclusi

## Art. 4301/CP - 4302/CP

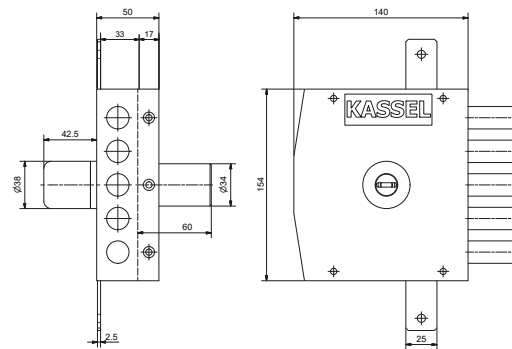
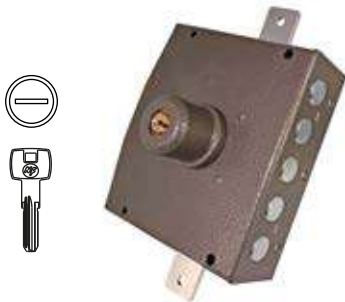

Materiale: Acciaio verniciato

Art.	Mano	Ingombro	Var.	Peso(g)	lmb.
4301/CP	DX	140X154X33	con aste	4.380	12
4302/CP	SX	140X154X33	con aste	4.380	12
4301SA/CP	DX	140X154X33	senza aste	2.880	12
4302SA/CP	SX	140X154X33	senza aste	2.880	12

## Serratura triplice senza scrocco

Three points lock without spring latch

Serrure à trois points sans ressort

Cerradura triple sin resbalón

Dreifachschloss ohne Riegel

**Kassel**

Serratura con coppia di  
spostamenti inclusi Art. 0604

## Art. 4351/CP - 4352/CP

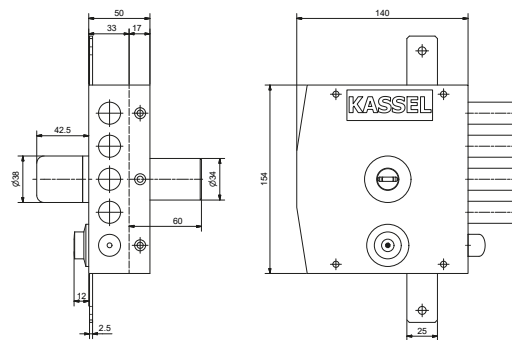
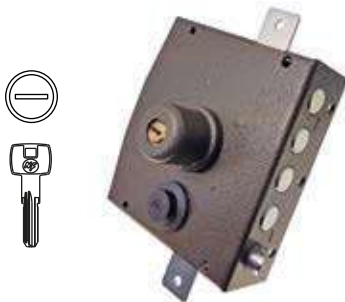

Materiale: Acciaio verniciato

Art.	Mano	Ingombro	Var.	Peso(g)	lmb.
4351/CP	DX	140X154X33	con aste	4.330	12
4352/CP	SX	140X154X33	con aste	4.330	12
4351SA/CP	DX	140X154X33	senza aste	2.830	12
4352SA/CP	SX	140X154X33	senza aste	2.830	12

## Serratura triplice con scrocco

Three points lock with spring latch

Serrure à trois points avec ressort

Cerradura triple con resbalón





Dreifachschloss mit Riegel

**Kassel**

Serratura con coppia di  
spostamenti inclusi Art. 0604

## Serratura quintupla con deviatore, senza scrocco

Art. 4501/CP - 4502/CP

-  *Five points side cylinder lock without spring latch with switch box*
-  *Serrure à cinq points sans ressort avec appareil de déviation*
-  *Cerradura quintuple sin resbalón desviador incluido*
-  *Fünffachverriegelung ohne Riegel, einschließlich Umlenkung*

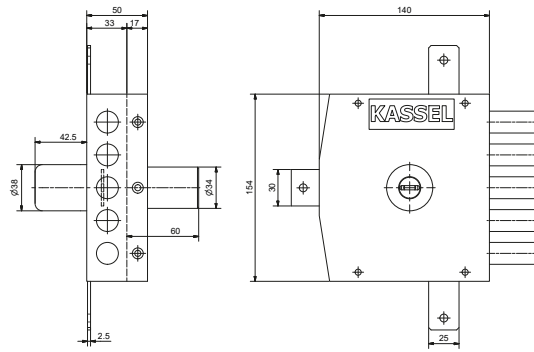

Materiale: Acciaio verniciato





**Kassel**

Serratura con coppia di spostamenti inclusi Art. 0604

Art.	Mano	Ingombro	Var.	Peso(g)	Imb.
4501/CP	DX	140X154X33	con aste	6.620	12
4502/CP	SX	140X154X33	con aste	6.620	12
4501SA/CP	DX	140X154X33	senza aste	3.420	12
4502SA/CP	SX	140X154X33	senza aste	3.420	12

## Serratura quintupla con deviatore, con scrocco

Art. 4551/CP - 4552/CP

-  *Five points side cylinder lock with spring latch with switch box*
-  *Serrure à cinq points avec ressort et appareil de déviation*
-  *Cerradura quintuple con resbalón desviador incluido*
-  *Fünffachverriegelung mit Riegel, einschließlich Umlenkung*

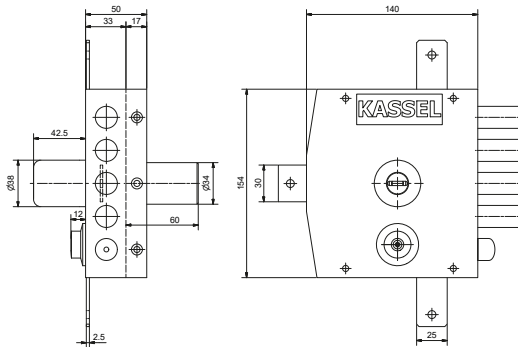

Materiale: Acciaio verniciato





**Kassel**

Serratura con coppia di spostamenti inclusi Art. 0604

Art.	Mano	Ingombro	Var.	Peso(g)	Imb.
4551/CP	DX	140X154X33	con aste	6.570	12
4552/CP	SX	140X154X33	con aste	6.570	12
4551SA/CP	DX	140X154X33	senza aste	3.370	12
4552SA/CP	SX	140X154X33	senza aste	3.370	12

## Serratura per basculante a 4 chiusure verticali, predisposta per altre due chiusure supplementari orizzontali. Apertura interna con chiave

Art. 6003/CP

-  *Lock with double cylinder for garage doors with 4 vertical locking points*
-  *Serrure pour porte de garage avec cylindre à clé plate, 4 fermetures verticales, prévue pour 2 fermetures horizontales supplémentaires. Ouverture interne avec clé*
-  *Cerradura para porton basculante con llave plana con 4 puntos de cierre verticales, preparada para dos puntos de cierre horizontales. Apertura interna con llave*
-  *Zylinderschloss mit Flachschlüssel mit 4 senkrechten Verriegelungspunkten, vorbereitet für zwei weitere horizontale Verschlüsse. Innenöffnung mit Knopf*

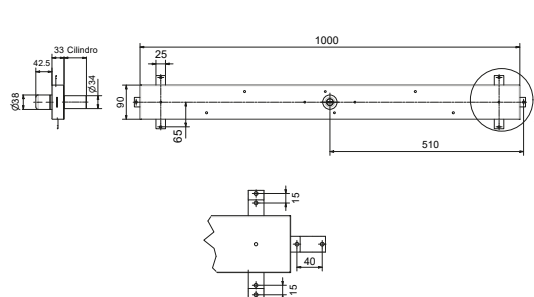

Materiale: Acciaio Verniciato

Art.	Var.	Apertura Interna	Cilindro	Peso(g)	Conf.
6003/6/CP	Con aste 6010	Chiave doppio cil.	60	6.550	1
6003/7/CP	Con aste 6010	Chiave doppio cil.	70	6.550	1
6003/6SA/CP	Senza Aste	Chiave doppio cil.	60	3.950	1
6003/7SA/CP	Senza Aste	Chiave doppio cil.	70	3.950	1

**Kassel**





Serratura con coppia di spostamenti inclusi Art. 0604

## TIPOLOGIA: SERRATURA A DOPPIA MAPPA TYPE: MULTILEVER LOCK

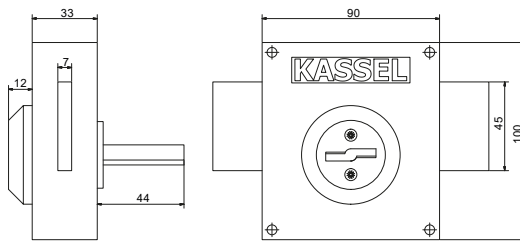
Art. 1010

Serratura laterale ambidestra



-  *Ambidextrous side lock*
-  *Serrure latérale ambidextre*
-  *Cerradura lateral ambidestra*
-  *Beidhändiges Seitenschloss*

Materiale: Acciaio verniciato





Art.	Ingombro	Peso(g)	lmb.
1010	90X100X33	1.580	16

**Kassel**

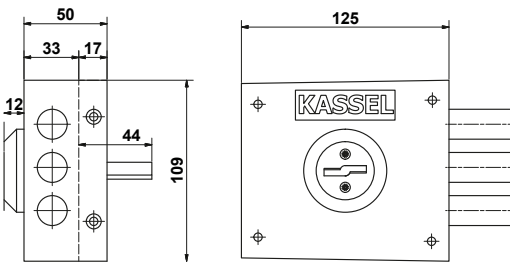
Art. 1001 - 1002

Serratura laterale senza scrocco



-  *Side lock without spring latch*
-  *Serrure latérale sans ressort*
-  *Cerradura lateral sin resbalón*
-  *Fallenloses Seitenschloss*

Materiale: Acciaio verniciato





Art.	Mano	Ingombro	Peso(g)	lmb.
1001	DX	125X105X33	1.420	16
1002	SX	125X105X33	1.420	16

**Kassel**

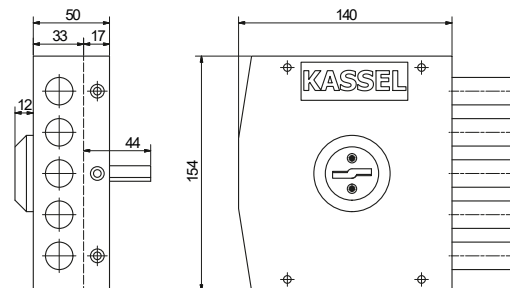
Art. 1101 - 1102

Serratura laterale senza scrocco



-  *Side lock without spring latch*
-  *Serrure latérale sans ressort*
-  *Cerradura lateral sin resbalón*
-  *Fallenloses Seitenschloss*

Materiale: Acciaio verniciato





Art.	Mano	Ingombro	Peso(g)	lmb.
1101	DX	140X154X33	2.670	12
1102	SX	140X154X33	2.670	12

**Kassel**

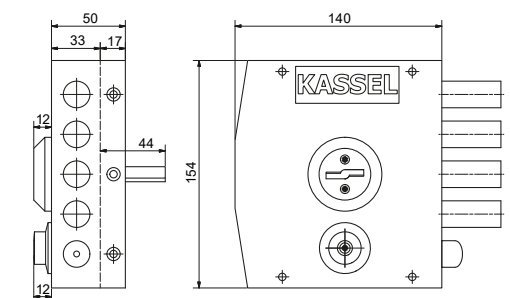
Art. 1151 - 1152

Serratura laterale con scrocco



-  *Side lock with spring latch*
-  *Serrure latérale avec ressort*
-  *Cerradura lateral con resbalón*
-  *Seitenschloss mit Riegel*

Materiale: Acciaio verniciato

Art.	Mano	Ingombro	Peso(g)	lmb.
1151	DX	140X154X33	2.620	12
1152	SX	140X154X33	2.620	12

**Kassel**

## Serratura triplice senza scrocco

Art. 1201 - 1202

Three points lock without spring latch

Serrure à trois points sans ressort

Cerradura triple sin resbalón

Dreifachschloss ohne Riegel

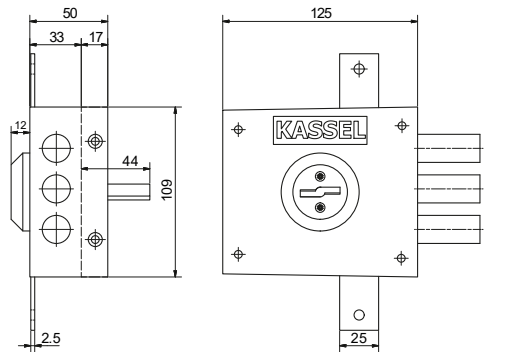

Materiale: Acciaio verniciato

**Kassel**

Serratura con coppia di spostamenti inclusi Art. 0604

Art.	Mano	Ingombro	Var.	Peso(g)	Imb.
1201	DX	125X105X33	con aste	2.970	16
1202	SX	125X105X33	con aste	2.970	16
1201SA	DX	125X105X33	senza aste	1.470	16
1202SA	SX	125X105X33	senza aste	1.470	16

## Serratura triplice senza scrocco

Art. 1301 - 1302

Three points lock without spring latch

Serrure à trois points sans ressort

Cerradura triple sin resbalón

Dreifachschloss ohne Riegel

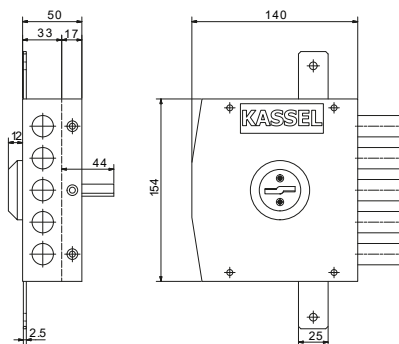

Materiale: Acciaio verniciato

**Kassel**

Serratura con coppia di spostamenti inclusi Art. 0604

Art.	Mano	Ingombro	Var.	Peso(g)	Imb.
1301	DX	140X154X33	con aste	4.320	12
1302	SX	140X154X33	con aste	4.320	12
1301SA	DX	140X154X33	senza aste	2.820	12
1302SA	SX	140X154X33	senza aste	2.820	12

## Serratura triplice con scrocco

Art. 1351 - 1352

Three points lock with spring latch

Serrure à trois points avec ressort

Cerradura triple con resbalón

Dreifachschloss mit Riegel

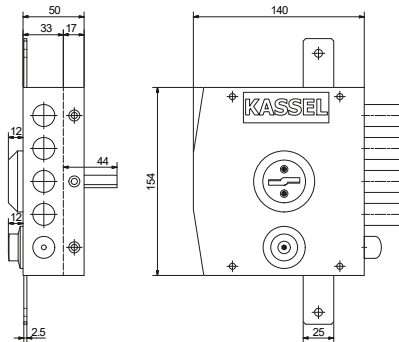

Materiale: Acciaio verniciato

**Kassel**

Serratura con coppia di spostamenti inclusi Art. 0604

Art.	Mano	Ingombro	Var.	Peso(g)	Imb.
1351	DX	140X154X33	con aste	4.270	12
1352	SX	140X154X33	con aste	4.270	12
1351SA	DX	140X154X33	senza aste	2.770	12
1352SA	SX	140X154X33	senza aste	2.770	12

## Art. 1501 - 1502

## Serratura quintupla con deviatore, senza scrocco

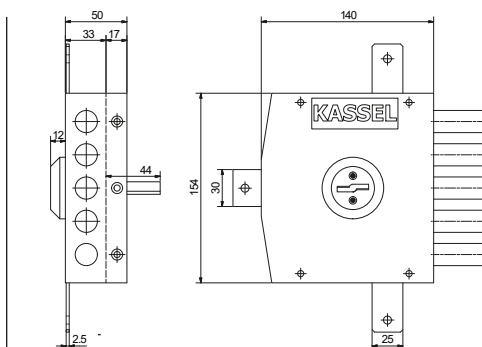

Five points side cylinder lock without spring latch with switch box

Serrure à cinq points sans ressort avec appareil de déviation

Cerradura quintuple sin resbalón desviador incluido

Fünffachverriegelung ohne Riegel, einschließlich Umlenkung

Materiale: Acciaio verniciato

Art.	Mano	Ingombro	Var.	Peso(g)	lmb.
1501	DX	140X154X33	con aste	6.600	12
1502	SX	140X154X33	con aste	6.600	12
1501SA	DX	140X154X33	senza aste	3.400	12
1502SA	SX	140X154X33	senza aste	3.400	12

**Kassel**

Serratura con coppia di spostamenti inclusi Art. 0604

## Art. 1551 - 1552

## Serratura quintupla con deviatore, con scrocco

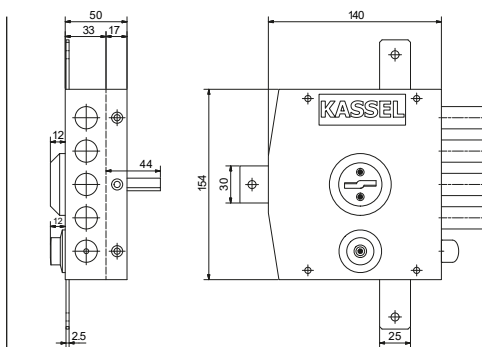

Five points side cylinder lock with spring latch with switch box

Serrure à cinq points avec ressort et appareil de déviation

Cerradura quintuple con resbalón desviador incluido

Fünffachverriegelung mit Riegel, einschließlich Umlenkung





Materiale: Acciaio verniciato

Art.	Mano	Ingombro	Var.	Peso(g)	lmb.
1551	DX	140X154X33	con aste	6.550	12
1552	SX	140X154X33	con aste	6.550	12
1551SA	DX	140X154X33	senza aste	3.350	12
1552SA	SX	140X154X33	senza aste	3.350	12

**Kassel**

## Serratura verticale con pomolo interno

Art. 2200

-  Vertical lock with internal knob
-  Serrure verticale avec bouton interne
-  Cerradura vertical con pomo interior
-  Senkrecht Türschloss mit Innerknopf, ohne Außenzylinder

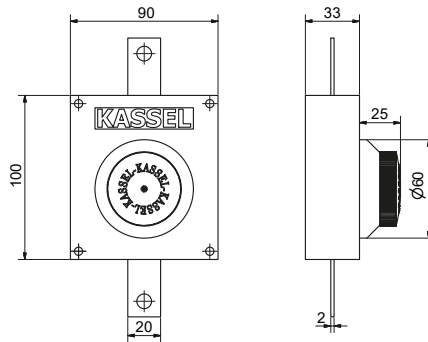

Materiale: Acciaio verniciato





**Kassel**

Serratura con coppia di spostamenti inclusi Art. 0604

Art.	Ingombro	Var.	Peso(g)	Imb.
2200	90X100X33	con aste	2.070	32
2200SA	90X100X33	senza aste	570	32

## Deviatore per aste quintuple

Art. 0506

-  Switch box for five points lock bars
-  Appareil de déviation pour barre serrures cinq points
-  Desviador para barras quintuple
-  Zusatzriegel für Fünffach-Türschloss

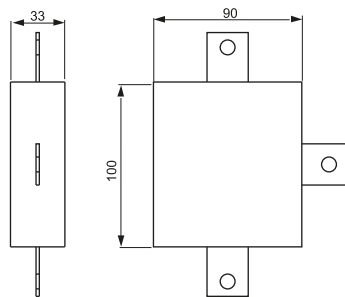

Materiale: Acciaio verniciato





**Kassel**

Serratura con coppia di spostamenti inclusi Art. 0604

Art.	Ingombro	Peso(g)	Imb.
0506	90X100X33	480	32

## Pozzetti antipolvere in ottone con molla in acciaio inox

Art. 149

-  Brass antidust cylinder with stainless steel spring
-  Cylindre antipoussière en laiton avec ressort en acier inox
-  Pocillo antipolvo de latón con resorte en acero inox
-  Staubfalle aus Messing mit Edelstahlfeder

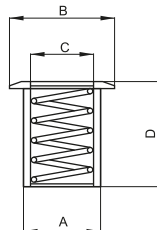

Materiale: Ottone, molla Inox

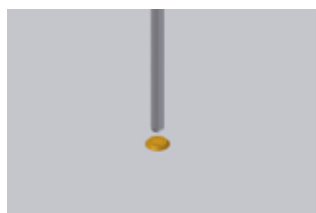

Art.	A	B	C	D	Peso(g)	Conf.
149/6	10	14	6	30	10	100
149/8	12	18	8	30	13	100
149/10	14	20	10	30	15	100
149/12	16	22	12	30	18	100
149/14	18	25	14	30	21	100
149/20	24	32	20	30	25	50
149/22	25	34	22	30	29	50



Art. 0609

Pozzetto a pavimento

**Kassel**



Floor cylinder

Cylindre pour sol

Boquilla para piso

Bodenzylinder

Art.	Peso(g)	Conf.
0609	30	10

Materiale: Ottone

Art. 0608

Cavallotto per aste

**Kassel**



Complete U-bolt for bars

Cavalier complet pour barres

Caballete para barras

Ü-bügel für Riegelungsstangen

Art.	Peso(g)	Conf.
0608	90	10

Materiale: Acciaio verniciato

Art. 0604

Coppia spostamenti per aste

**Kassel**



Swivel couple for bars

Couple déplacement pour barres

Juego de desviadores

Paar gekröpfte Umdrehungsbanden für Metallstangen

Art.	Peso(g)	Conf.
0604	80	10

Materiale: Acciaio verniciato

Art. 0601

Asta singola verniciata Ø15 lungh. cm 130

**Kassel**



Single painted bar Ø15mm length cm 130

Barre simple peinte Ø15mm longueur cm 130

Barra simple pintada Ø15mm longitud cm 130

Paar Lackierte Stangen Ø15mm, Länge 130 cm

Art.	Peso(g)	Conf.
0601	470	1

Materiale: Acciaio verniciato / decapato

Art. 0602 - 0603

Aste telescopiche per porte blindate con boccola e grani

**Kassel**



Telescopic bars for armoured doors with bushing and grub screws

Barres télescopiques pour portes blindées avec douille et vis sans tête

Barras telescópicas para puertas blindadas on casquillo y tornillos prisioneros

Teleskopstangen für Panzertüren mit Buchse und Gewindestiften

Art.	Var.	Peso(g)	Conf.
0602	Verniciata	1.180	20
0603	Grezza	1.180	20

Materiale: Acciaio verniciato / decapato  
Acciaio grezzo

## Aste telescopiche verniciate per serrature triplici con accessori

Art. 0503

-  *Painted telescopic bars for triple locks with accessories*
-  *Barres télescopiques peintes pour serrures triples avec accessoires*
-  *Barras telescópicas pintadas para cerraduras triples con accesorios*
-  *Lackierte Teleskopstangen für Dreifachschlösser mit Zubehör*

**Kassel**<sup>®</sup>







Materiale: Acciaio verniciato

Art.	Peso(g)	Conf.
0503	1.500	1

## Aste telescopiche verniciate per serrature quintuple con accessori

Art. 0504

-  *Painted telescopic bars for five point locks with accessories*
-  *Barres télescopiques peintes pour serrures cinq points avec accessoires*
-  *Barras telescópicas pintadas para cerraduras quinuple con accesorios*
-  *Lackierte Teleskopstangen für Fünffachschlösser mit Zubehör*

**Kassel**<sup>®</sup>







Materiale: Acciaio verniciato

Art.	Peso(g)	Conf.
0504	3.200	1

## Aste telescopiche verniciate per basculanti a 4 chiusure verticali con accessori

Art. 6010

-  *Painted telescopic bars for 4-way up-and-over doors with accessories*
-  *Barres télescopiques peintes pour portes basculantes à 4 voies avec accessoires*
-  *Barras telescópicas pintadas para puertas basculantes de 4 vías con accesorios*
-  *Lackierte Teleskopstangen für 4-Wege-Schwingtore mit Zubehör*

**Kassel**<sup>®</sup>







Materiale: Acciaio verniciato

Art.	Peso(g)	Conf.
6010	2.600	1

## Aste telescopiche verniciate per basculanti a 2 chiusure orizzontali con accessori

Art. 6011

-  *Painted telescopic bars for 2-way up-and-over doors with accessories*
-  *Barres télescopiques peintes pour portes basculantes à 2 voies avec accessoires*
-  *Barras telescópicas pintadas para puertas basculantes de 2 vías con accesorios*
-  *Lackierte Teleskopstangen für 2-Wege-Schwingtore mit Zubehör*

**Kassel**<sup>®</sup>



Materiale: Acciaio verniciato

Art.	Peso(g)	Conf.
6011	1.500	1





Art. 0001-0002-0003-0012-0013

Pacchetto gorges (doppia mappa)

**Kassel**



Materiale: Acciaio verniciato

-  Pack of gorges (multilever lock)
-  Pack de gorges (serrure multilevier)
-  Paquete de gargantas (cerradura multipalanca)
-  Schluchtenpaket (Mehrfachverriegelung)

Art.	Mano	Abbinato	Peso(g)	Conf.
0001	Dx	Serr.Grande1351	300	1
0002	Sx	Serr.Grande1352	300	1
0003	--	Art. 1010	200	1
0012	Dx	Art. 1001-1201	200	1
0013	Sx	Art. 1002-1202	230	1





Art. 0004-0005-0006-0007

Cilindro di sicurezza tondo (chiave reversibile)

**Kassel**



Materiale: Acciaio verniciato

-  Cylinder complete with three keys
-  Cylindre complete de trois clef
-  Cilindro para llave plana con tres llaves
-  Pumpezyylinder mit drei Schlüsseln

Art.	Ingombro	Peso(g)	Conf.
0004/6CP - 0004/7CP - 0004/8CP	85 x 95 x (60/70/80)	480	1
0005/6CP - 0005/7CP - 0005/8CP	103 x 124 x (60/70/80)	640	1
0006/6CP - 0006/7CP - 0006/8CP	135 x 148 x (60/70/80)	640	1
0007/6CP - 0007/7CP - 0007/8CP	76 x 152 x (60/70/80)	680	1





Art. 0610

Pomolo adattatore

**Kassel**



Materiale: Acciaio verniciato

-  Spring latch adapter
-  Tireur adaptateur
-  Empuñadura adaptadora
-  Federriegeladapter

Art.	Var.	Peso(g)	Conf.
0610	Cataforesi	32	10





Art. 0010 - 0011 - 0018

Bocchette esterne piane

**Kassel**



Materiale: Acciaio verniciato

-  Plain external plates
-  Platines extérieures planes
-  Escudo exterior plano
-  Flach-Schliessblech

Art.	Var.	Peso(g)	Conf.
0010	Cilindro tondo	20	5
0011	Doppia mappa	20	5
0018	Cilindro europeo	20	5





Art. 0016-0017

Bocchette esterne concave complete di 4 viti

**Kassel**



Materiale: Acciaio verniciato

-  Concave external plates with 4 screws
-  Platines extérieures concaves avec 4 vis
-  Escudo exterior cóncavo con 4 tornillos
-  Konkav-Schliessblech mit 4 Schrauben

Art.	Var.	Peso(g)	Conf.
0016	Cilindro tondo	20	5
0017	Doppia mappa	20	5

## Chiavi di ricambio

Art. 0044 - 0045 - 0046 - 0047 - 0048 -0048.F

Replacement keys

Clefs de recharge

Llaves de recambio

Ersatzschlüssel

Art.	Var.	Peso(g)	Conf.
0044	Corta a pompa	20	10
0045	Lunga a doppia mappa	40	10
0046	Chiave a pettine (per serranda)	10	10
0047	Doppia mappa corta (per serranda)	20	10
0048	Chiave reversibile versione precedente	16	10
0048.F	Chiave reversibile	16	10



Per capire qual è l'Art. del quale avete bisogno controllate le chiavi in dotazione alla serratura e scegliete la corrispondente grezza

To find out which Art. you need, check the keys supplied with the lock and choose the corresponding blank

**Kassel**



Materiale: Acciaio forgiato

## Ferrogliere

Art. 0049 - 0050 - 0051 - 0052

Counter box

Contre plaque

Cerraderos

Winkelschließblech für Türschlösser

Art.	Mano	Var.	Peso(g)	Conf.
0049	37 x 100 x 33	Asola	190	1
0050	52 x 154 x 33	5 Fori	300	1
0051	45 x 105 x 33	3 Fori	220	1
0052	52 x 154 x 45	5 Fori Alta	300	1

**Kassel**



Materiale: Acciaio forgiato

## Boccola con grano per aste

Art. 0606

Ring with grain for bars

Bague avec grain pour barres

Arandela con prisionero para barras

Büchse mit Nut Schraube für Metallstangen

Art.	Peso(g)	Conf.
0606	15	10

**Kassel**



Materiale: Acciaio verniciato

## Guida per aste con anello in plastica e due viti zincate nere

Art. 0607

Guide for bars with plastic ring and 2 black painted screws

Guide pour barres avec plastique bague et 2 vis vernies noir

Guía para barras con anillo plástico y 2 tornillos barnizados

Bügelschelle für Metallstangen mit Kunststoffring und zwei schwarze verzinkte Schrauben

Art.	Peso(g)	Conf.
0607	30	10

**Kassel**



Materiale: Acciaio verniciato

## TIPOLOGIA: CILINDRO TONDO, CHIAVE A PETTINE TYPE: ROUND CYLINDER, FLAT KEY

Art. 5301 - 5302 - 5311 - 5312 - 5400 - 5410

Serratura laterale per serrande, con cilindro completa di n.2 chiavi e perno di trascinamento aste. Corsa mm24, cursore dritto o piegato

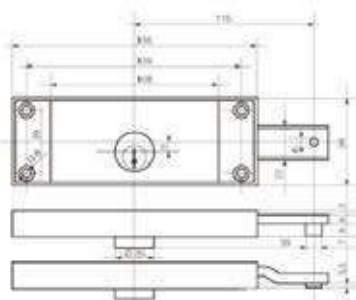
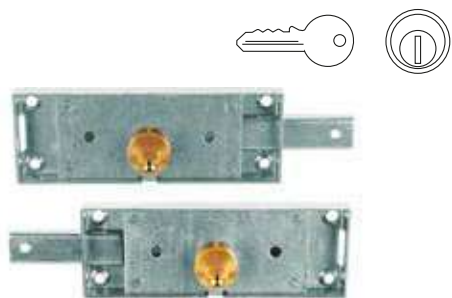

Materiale: Acciaio Zincato

Art.	Mano	Cursore	Cilindro	Peso(g)	Conf.
5301	Dx	Dritto	Normale	500	14
5302	Sx	Dritto	Normale	500	14
5311	Dx	Piegato	Normale	500	14
5312	Sx	Piegato	Normale	500	14
5311/P	Dx	Piegato Prol.	Normale	500	14
5312/P	Sx	Piegato Prol.	Normale	500	14
5301/L	Dx	Dritto	Prolungato	500	14
5302/L	Sx	Dritto	Prolungato	500	14
5311/L	Dx	Piegato	Prolungato	500	14
5312/L	Sx	Piegato	Prolungato	500	14
5311/PL	Dx	Piegato Prol.	Prolungato	500	14
5312/PL	Sx	Piegato Prol.	Prolungato	500	14
5400	Dx+Sx	Dritti	Normale	1.080	8
5410	Dx+Sx	Piegati	Normale	1.080	8
5410/P	Dx+Sx	Piegato Prol.	Normale	1.080	8
5400/L	Dx+Sx	Dritti	Prolungato	1.080	8
5410/L	Dx+Sx	Piegati	Prolungato	1.080	8
5410/PL	Dx+Sx	Piegato Prol.	Prolungato	1.080	8

🇬🇧 Side cylinder lock for rolling shutter complete with 2 keys and pin for bar fixing. Stroke mm24, straight or bended bars hooking

🇫🇷 Serrure latérale avec cylindre pour rideaux roulants avec 2 clefs et pivot pour fixation barres. Course mm24, accrochage barres droit ou plié

🇪🇸 Cerradura lateral con cilindro para persianas, completa 2 llaves y pernio de fijación barra. Recorrido mm24, desviador derecho o plegado

🇩🇪 Roll-Garagentorschloss, Seitlich Schließend, mit Zylinder, zwei Schlüsseln und Ziehriegel. Riegelbewegung: 24mm. Gekröpfte oder geLaufrollee Riegel

**Kassel**

Art. 5600 - 5610

Serratura centrale per serrande, con cilindro completa di n.2 chiavi e perno di trascinamento aste. Corsa mm24, cursore dritto o piegato

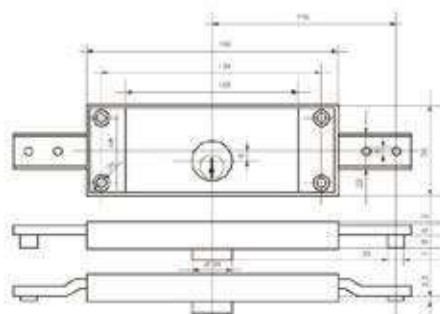
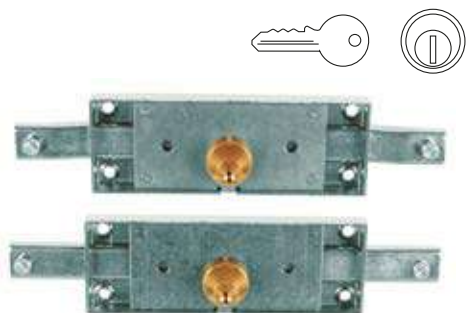

Materiale: Acciaio Zincato

Art.	Cursore	Cilindro	Peso(g)	Conf.
5600	Dritto	Normale	580	14
5610	Piegato	Normale	580	14
5600/L	Diritto	Prolungato	580	14
5610/L	Piegato	Prolungato	580	14
5610/PL	Piegato Prol.	Prolungato	580	14

🇬🇧 Central cylinder lock for rolling shutter with 2 keys and pin for bar fixing. Stroke mm24, straight or bended bars hooking

🇫🇷 Serrure centrale avec cylindre pour rideaux roulant avec 2 clefs et pivot pour fixation barres. Course mm24, accrochage barres droit ou plié

🇪🇸 Cerradura central para con cilindro persianas, completa de 2 llaves y pernio de fijación barra. Recorrido mm24, desviador derecho o plegado

🇩🇪 Roll-Garagentorschloss, Zentral schließend mit Zylinder, zwei Schlüsseln und Ziehriegel. Riegelbewegung : 24mm. Gekröpfte oder geLaufrollee Riegel

**Kassel**

## TIPOLOGIA: DOPPIA MAPPA TYPE: MULTILEVER LOCK

Serratura laterale per serrande, a doppia mappa completa di n.2 chiavi e perno di trascinamento aste. Corsa mm20, cursore diritto o piegato

Art. 5001 - 5002 - 5011 - 5012 - 5500 - 5510

 Side multilever lock for rolling shutter with 2 keys and pin for bar joint. Stroke mm20, straight or bended bars hooking

 Serrure latérale à panetton double pour rideaux roulant avec 2 clefs et pivot pour fixation barres. Course mm20, accrochage barres droit ou plié

 Cerradura lateral a doble paletón para persianas, completa de 2 llaves y perno de fijación barra. Recorrido mm20, desviador derecho o plegado

 Roll-Garagentorschloss, seitlich schließend, Doppelzylinder mit zwei Schlüsseln und Ziehriegel. Stangebewegung: 20 mm. mit Gekröpften oder geLaufrollee Riegel

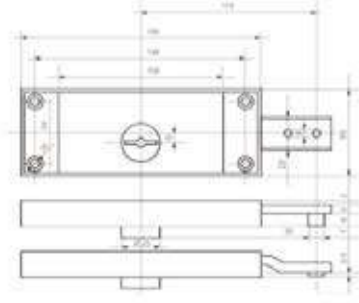

Materiale: Acciaio Zincato

Art.	Mano	Cursore	Peso(g)	Conf.
5001	Dx	Dritto	500	14
5002	Sx	Dritto	500	14
5011	Dx	Piegato	500	14
5012	Sx	Piegato	500	14
5011/P	Dx	Piegato prol	500	14
5012/P	Sx	Piegato prol	500	14
5500	Dx+Sx	Dritti	1.000	8
5510	Dx+Sx	Piegati	1.000	8
5510/P	Dx+Sx	Piegato prol	1.000	8

**Kassel**

Serratura centrale per serrande, a doppia mappa completa di n.2 chiavi e perno di trascinamento aste. Corsa mm20, cursore diritto o piegato

Art. 5100 - 5110

 Central multilever lock for rolling shutter complete with 2 keys and pin for bar joint. Stroke mm24, straight or bended bars hooking

 Serrure centrale à panetton double pour rideaux roulant avec 2 clefs et pivot pour fixation barres. Course mm24, accrochage barres droit ou plié

 Cerradura central a doble mapa para persianas, completa de 2 llaves y perno de fijación barra. Recorrido mm24, desviador derecho o plegado

 Roll-Garagentorschloss, zentral schließend, Doppelzylinder, mit zwei Schlüsseln und Ziehriegel nach Links und nach Rechts. Riegelbewegung: 20mm. Gekröpft oder geLaufrollee Riegel

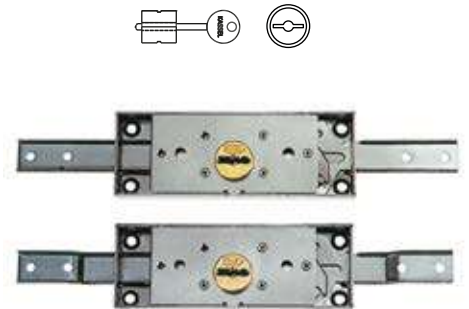
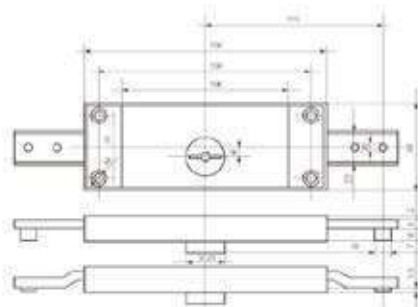

Materiale: Acciaio Zincato

Art.	Cursore	Peso(g)	Conf.
5100	Dritto	580	14
5110	Piegato	580	14
5110/P	Piegato prol.	580	14

**Kassel**

Art. 5200 - 5210

Serratura triplice a doppia mappa per serrande, con 2 chiavi e perno di trascinamento per aste.  
Corsa aste mm20, cursore diritto o piegato



Materiale: Acciaio Zincato

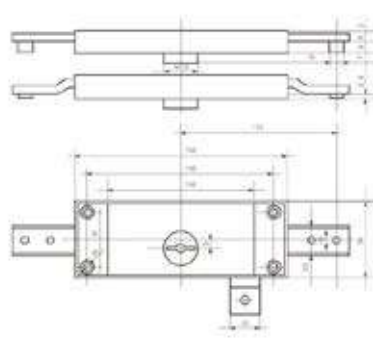

Art.	Cursore	Peso(g)	Conf.
5200	Diritto	630	14
5210	Piegato	630	14

Three points multilever lock for rolling shutter with 2 keys and pin for bar joint. Bar stroke mm20, straight or bended bars hooking

Serrure à trois points à panneton double pour rideaux roulants avec 2 clefs et pivot pour fixation barres. Course barres mm20, accrochage barres droit ou plié

Cerradura triple con doble paletón para persianas, con 2 llaves y pernio de fijación barra. Desviador derecho ó plegado

Dreifach-Doppel Bit Schloss, für Roll-Garagentor, mit zwei Schlüsseln und Ziehriegel. Riegelbewegung: 20mm. Gekröpft oder geLaufrollee Riegel

**Kassel**

Art. 5000

Piastra di fissaggio per serrature laterali e centrali



Materiale: Acciaio Zincato

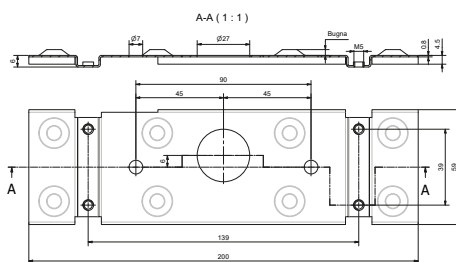

Art.	Var.	Peso(g)	Conf.
5000/1	Piana	90	10
5000/2	Bugna mm 1,2	90	10
5000/3	Bugna mm 3	90	10

Fixing plate for side and central locks

Platin de fixation pour serrure latérales et centrales

Placa de fijación cerraduras laterales y centrales

Befestigungsplatte für seitliche und zentrale Garagentorschlösser.

**Kassel**

Art. 254

Catenaccio portalucchetto zincato



Materiale: Acciaio zincato

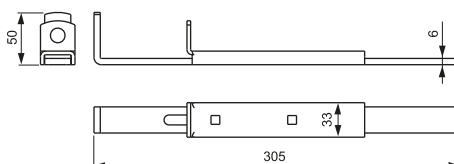

Art.	Peso(g)	Conf.
254	380	20

Galvanized bolt for padlocks

Verrou porte cadenas zinguée

Pestillo portacantado cincado

Türschlossriegel, aus verzinktem Stahl



## Kit serratura per sezionali

Art. 6005

Lock for sectional gates kit

Kit serrure pour portes sectionnelles

Kit cerradura para puertas seccionales

Schlosskasten für Sektionaltore

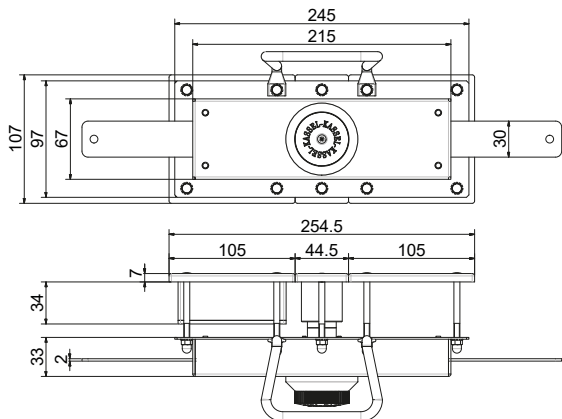

**Kassel**



Materiale: Maniglia esterna in nylon - interna in acciaio  
Serratura in acciaio verniciato

Art.	Peso(g)
6005	2.600

Articolo fornito SENZA ASTE

## Maniglia in nylon con piastra in acciaio zincato con viti

Art. 6007

Nylon handle with steel plate with screws

Poignée en nylon avec plaque en acier avec vis

Manija de nylon con placa de acero con tornillos

Nylongriff mit Stahlplatte

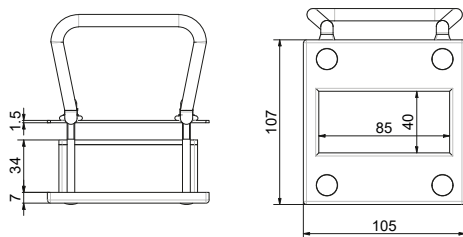

Materiale: Nylon e acciaio zincato

**Kassel**

Art.	Peso(g)
6007	330

## Coppia di aste telescopiche per sezionali

Art. 0507

Couple of telescopic bars for sectional gates

Paire de tiges télescopiques pour portes sectionnelles

Par de barras telescópicas para puertas seccionales

Teleskopstangen für Sektionaltore



Materiale: Acciaio verniciato

**Kassel**

Art.	L max(cm)	Peso(g)
0507	263	2.100



# NOVA-FERR srl

ACCESSORI PER PORTONI INDUSTRIALI  
ACCESSORIES FOR INDUSTRIAL DOORS



## NOVAGUIDE<sup>®</sup>

Alcune applicazioni con sistema NOVAGUIDE

PORTONI A LIBRO



PORTONI SCORREVOLI



PORTE



CANCELLI A BATTENTE



CANCELLI SCORREVOLI



PARETI DIVISORIE



CABINE INSONORIZZANTI



STAND



PARETI VENTILATE



PARETI RIVESTITE



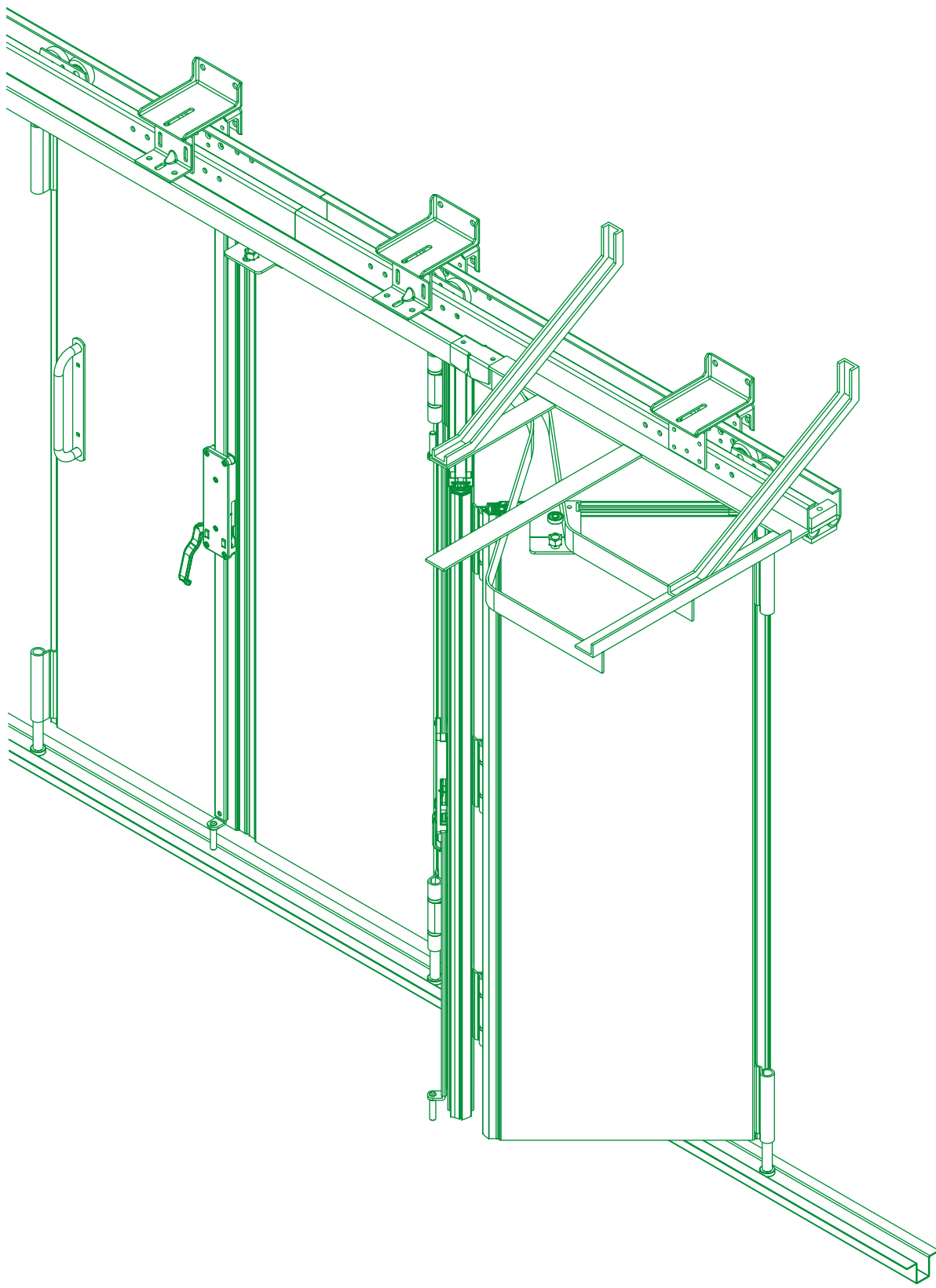

# ACCESSORI PER PORTONI INDUSTRIALI

Accessories for industrial doors  
Accessoires pour portes industrielles  
Accesorios para puertas industriales  
Zubehör für Industrietore

**CATALOGO  
N.25**

Art. 3186

Profilo zincato di 6mt per telaio porta pannello



**Brevettato  
Patented**

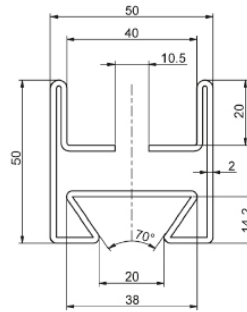

Galvanized profile of 6mt. for panel frame

Profil zingué de 6mt. pour cadre de panneaux

Perfil cincado de 6mt. para marco de paneles

Verzinktes Stahlprofil 6 mt lang für Paneele

Materiale: Acciaio zincato

Art.	Peso(g/m)	Conf.
3186	3.560	40
3186/ST	Stampo per foratura	40 Kg 1



**NOVAGUIDE®**

## Sistema di fissaggio e tipologie di pannelli

Grazie al profilo porta pannello brevettato da Nova-Ferr, il fissaggio del pannello e la regolazione degli accessori risultano semplici e sicuri



Profilo porta pannello



Bloccaggio facile e sicuro



Regolazione

### Infilare



Viene inserito un pannello da 40mm  
Il pannello deve essere scantonato negli angoli  
il pannello deve essere tagliato di misura per far corpo unico con la struttura

### Schiumare



La struttura viene avvolta da due fogli di lamiera  
All'interno tramite apposite schiumatrici viene inniettato il poliuretano per la costruzione dell'anta

### Incollare



La struttura viene avvolta da due fogli di lamiera  
All'interno viene inserito un foglio di polistirolo  
e poi il tutto posto sotto una pressa nei tempi idonei a far agire il collante

Art. 3188

Profilo zincato di 6mt. per controtelaio

**Brevettato**



Materiale: Acciaio zincato

Art.	Peso(g/m)	Conf.
3188	2.200	2

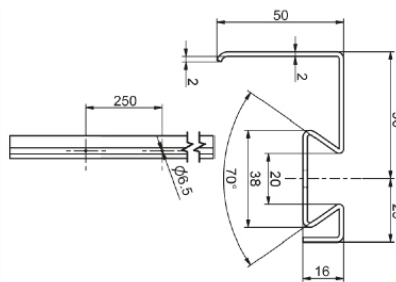

Galvanized profile of 6mt. for door frame

Profil zingué de 6mt. pour chassis de porte

Perfil cincado de 6mt. para bastidores

Verzinktes Stahlprofil für Gegenrahmen





**NOVAGUIDE®**

Squadretta di giunzione angolare per profilo Art. 3186

Art. 3187

 Angular junction square for profile Art. 3186

 Equerre de jonction pour profil Art. 3186

 Escuadra de unión para perfil Art. 3186

 Winkelbefestigung für Profil 3186

NOVAGUIDE®

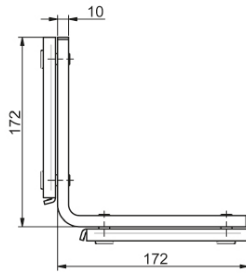

Brevettato



Materiale: Acciaio zincato

Art.	Peso(g)	Conf.
3187	1.080	16



Inserimento squadretta

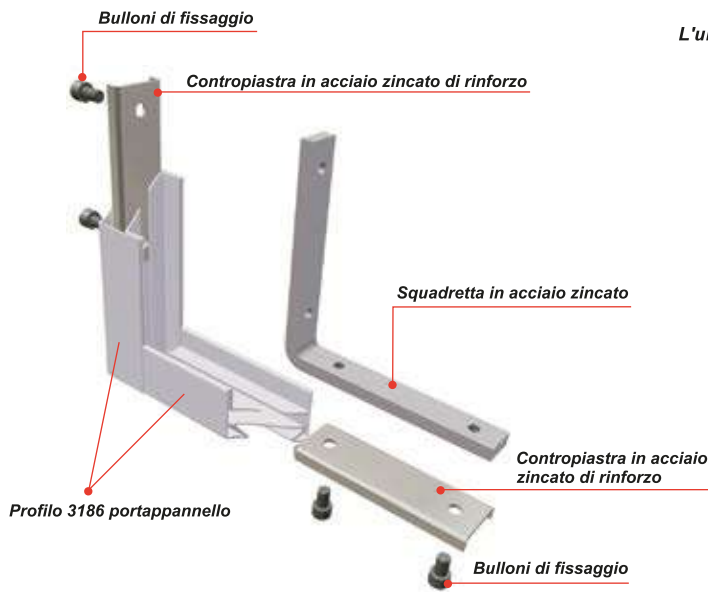

L'unione e quindi la costruzione delle ante avviene tramite una squadretta in acciaio zincato

- Taglio del profilo 3186 a 90° o 45°
- Foratura del profilo tramite dima di foratura o stampo
- Inserimento squadretta e assemblaggio anta

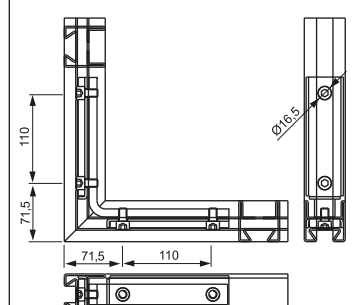
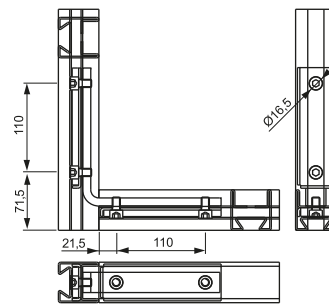

Tramite uno stampo è possibile avere la foratura ad interessi esatti del profilo 3186

Art. 3186/ST Stampo per foratura

Art.	Peso	Conf.
Art. 3186/ST	40Kg	1





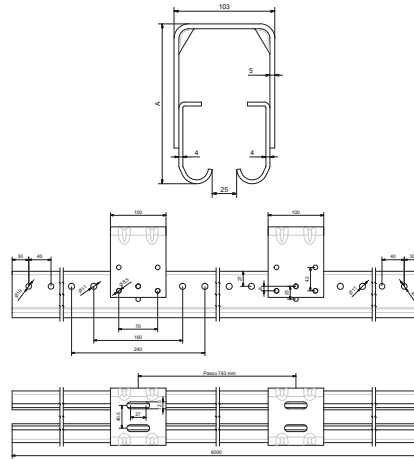

## GUIDE SUPERIORI - TOP GUIDES

Art. 3183

Monorotaia zincata assemblata con cavallotto, 6mt. di lunghezza



-  Staple assembled galvanized guide, 6mt length
-  Guide montée zinguée avec cavalier, 6 mt de longueur
-  Monoguía cincada asemlada con soporte, 6mt larga
-  Verzinktes Einschienenbahn mit U-Klammern, 6 Meter lang

Materiale: Acciaio zincato

Art.	A	Peso(g/m)	lmb.
3183.1	163	9.760	1
3183.2	137	9.660	1





**NOVAGUIDE®**

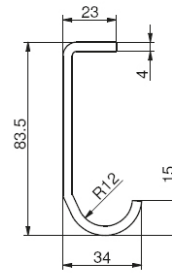

Art. 83/2 - 3083

Binario non forato o preforato in acciaio zincato, 6mt di lunghezza



-  Not pierced or pierced galvanized steel track, 6mt length
-  Rail en acier galvanisé non perforé ou pré-percé, longueur 6 m
-  Carril de acero cincado sin perforar o preperforado, de 6 m largo
-  Ungelochte oder vorgebohrte verzinkte Stahlschiene, 6 m lang

Materiale: Acciaio zincato

Art.	Var.	Peso(g/m)	lmb.
83/2	non forato	4.000	2
3083	preferato	3.950	2





**NOVAGUIDE®**

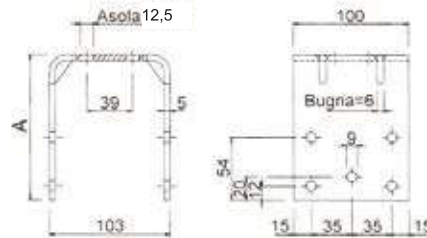

Art. 3006

Cavallotto assemblaggio dei binari Art. 3183



-  Staple for upper track assembly for Art. 3183
-  Cavalier pour assemblage rail supérieur pour Art. 3183
-  Puente para ensamblaje guía Art. 3183
-  U Klammer für Zusammenbau der Führungsschiene Art. 3183

Materiale: Acciaio zincato

Art.	A	Peso(g)	Conf.
3006.1	127	1.220	8
3006.2	101	1.000	8

**NOVAGUIDE®**



**Piastra di giunzione in acciaio zincato preforata per binario Art. 3183**

**Art. 3014**

Pierced galvanized steel joint plate for Art. 3183

Platine de jonction pre-perforée en acier zingué pour Art. 3183

Placa de unión perforada en acero cincado para guía Art.3183

Übergangplatte aus verzinktem Stahl mit Ose für Schiene Art.3183

**NOVAGUIDE®**

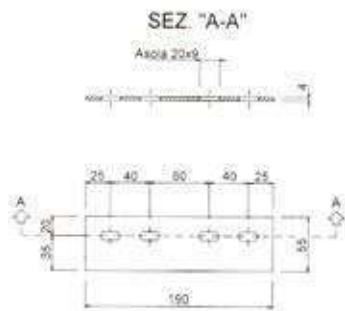

Materiale: Acciaio zincato

Art.	Peso(g)	Conf.
3014	300	35



**Monorotaia in acciaio zincato con asole, 6mt. di lunghezza**

**Art. 3088**

Galvanized steel guide with slots, 6mt length

Guide en acier zingué avec fentes, 6mt de longueur

Monoguía de acero cincado con oiales, 6mt larga

Einschienenbahn aus verzinktem Stahl mit Ösen, 6 mt. lang

**NOVAGUIDE®**

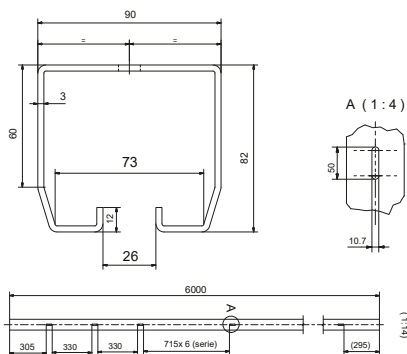

Materiale: Acciaio zincato

Art.	Peso(g/m)	lmb.
3088	7.000	1



**Giuntore per guida chiusa 3088**

**Art. 3085**

Joint bracket for 3088 guide

Support de jonction

Soporte de unión guía 3088

Verbindungsstück für geschlossene 3088 Laufschiene

**NOVAGUIDE®**

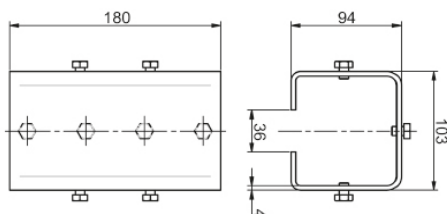

Materiale: Acciaio zincato

Art.	Peso(g)	Conf.
3085	1.930	2



## Art. 3009

## Morsetto di finecorsa per Art. 3088 - 3183

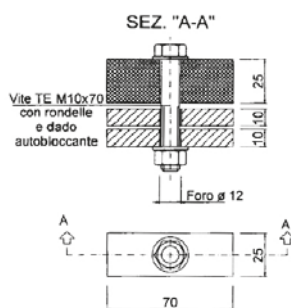

Materiale: Acciaio zincato

Buckle slide-rest for Art. 3088-3183

Borne fin de course pour Art. 3088-3183

Fin de carril para guía para Art. 3088-3183

Endanschlagklemme für Art. 3088-3183

Art.	Peso(g)	Conf.
3009	380	8

**NOVAGUIDE®**



## Art. 50

## Monorotaia in acciaio zincato in barre da 6mt

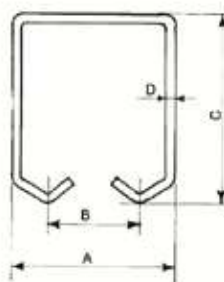

Materiale: Acciaio zincato

Galvanized steel track 6mt length

Rail en acier zingué 6mt de longueur

Monoguía de acero cincado 6mt larga

Einschienenbahn aus verzinktem Stahl- Stange aus 6mt

Art.	A	B	C	D	Peso(g/m)	Imb.
50	42	22	54	2,5	3.100	3

**NOVAGUIDE®**



## Art. 3910

## Monorotaia per carrello Art. 3901

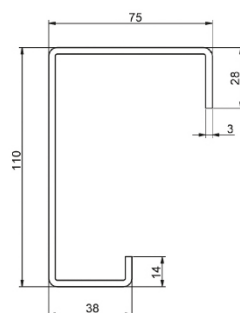

Materiale: Acciaio zincato

Guide for hanger Art. 3901

Guide pour chariot Art. 3901

Guía para roldana Art. 3901

Einschienenbahn für Rollenapparate Art. 3901





Art.	L(m)	Peso(g/m)	Imb.
3910	6	6.700	1

**NOVAGUIDE®**



Supporto per monorotaia Art. 3910

Art. 3920

-  Wall adjustable bracket for guide Art. 3910
-  Support mural réglable pour guide supérieure Art. 3910
-  Soporte para guía Art.3910
-  Verstellbare Unterstützung für Einschienenbahn Art. 3910

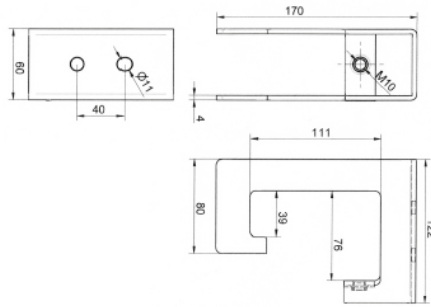

Materiale: Acciaio zincato



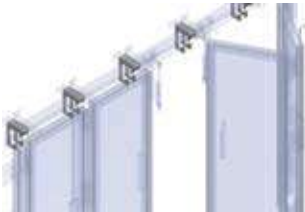

Art.	Peso(g)	Conf.
3920	860	6

NOVAGUIDE®



Supporto per monorotaia

Art. 3084

-  Wall adjustable bracket for guide
-  Support mural réglable pour guide
-  Soporte para guía
-  Unterstützung für Einschienenbahn

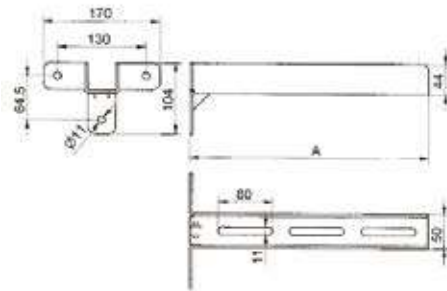

Materiale: Acciaio zincato





Art.	A	Peso(g)	Conf.
3084.1	250	1.158	15
3084.2	350	1.532	10
3084.3	450	1.906	6

NOVAGUIDE®



Supporto regolabile per fissaggio a parete della guida superiore

Art. 3003

-  Wall adjustable bracket for upper guide
-  Support mural réglable pour guide supérieure
-  Soporte regulable para fijar guía superior a pared
-  Verstellbarer Stützbügel für die Wandmontage des oberen Führungs

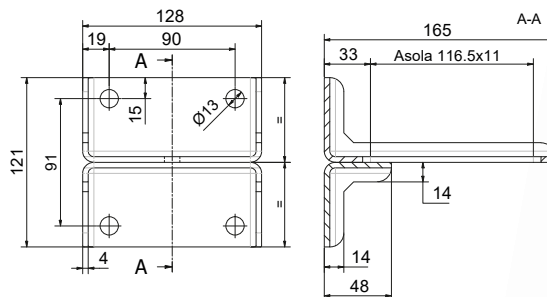

Materiale: Acciaio zincato

Art.	Var.	Peso(g)	Conf.
3003	con aletta inferiore	1.330	4
3003.1	senza aletta inferiore	1.180	6



NOVAGUIDE®





## Art. 3010

## Guida preforata per deviatore in acciaio zincato, 6mt. di lunghezza

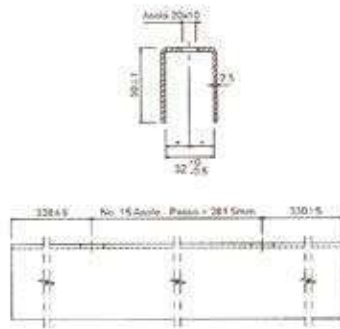

Pierced galvanized steel guide for deflector, 6mt. length

Rail pre-perforée en acier zingué pour appareil de deviation, 6mt de longueur

Guía perforada para desviador de acero cincado, 6mt larga

Gelöchertes Einschienenbahn für Kulissenführung aus verzinktem Stahl. Länge: 6m

Materiale: Acciaio zincato

Art.	Peso(g/m)	Conf.
3010	2.600	2

**NOVAGUIDE®**



## Art. 3004

## Staffa regolabile di supporto per guida deviatore

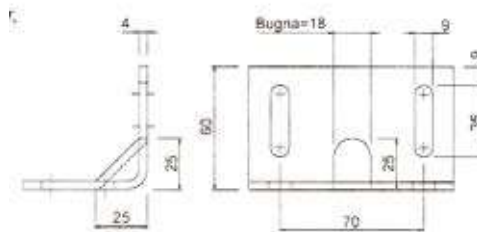

Adjustable stand clamp for deflector guide

Etrier réglable de support pour guide appareil de deviation

Angulo soporte de guía desviador

Verstellbarer Befestigungsbügel für Kulissenführung

Materiale: Acciaio zincato

Art.	Peso(g)	Conf.
3004	390	16

**NOVAGUIDE®**



## Art. 3015

## Deviatore regolabile sistema a coda di rondine

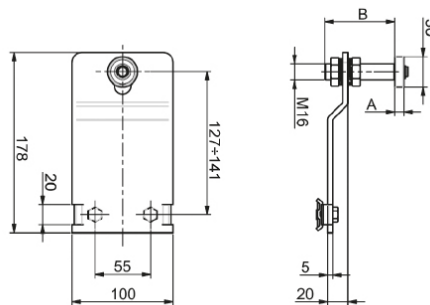

Adjustable diverter dovetail system

Système de déviation réglable à queue d'aronde

Desviador ajustable sistema de cola de milano

Einstellbares Umlenkschwabenschwanzsystem

Materiale: Acciaio zincato

Art.	Var.	A	B	Peso(g)	Conf.
3015/30.4	Cuscinetto	9	69	904	8
3015/30.5	Oliva	25	55	980	8

**NOVAGUIDE®**



Deviatore regolabile sistema ad avvitare

Art. 3002

Adjustable diverter screw system

Système de déviation réglable à visser

Desviador ajustable atornillable

Einstellbares Umlenksystem zum Anschrauben

NOVAGUIDE®

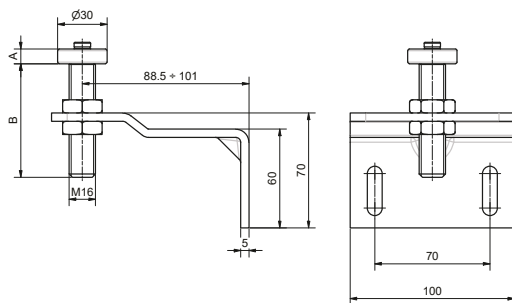

Materiale: Acciaio zincato

Art.	Var.	A	B	Peso(g)	Conf.
3002/30.4	Cuscinetto	9	69	802	8
3002/30.5	Oliva	25	55	885	8



Raccogliitore ante

Art. 3012 - 3013

Multi-leaf door collector

Rassembleur des portes

Recogedor guía

Kulisse Bindemittel

NOVAGUIDE®

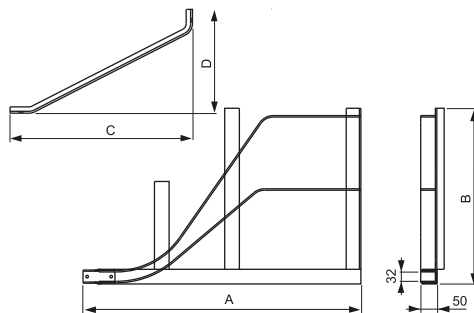

Materiale: Acciaio verniciato

Art.	Var.	A	B	C	D	Ante	Peso(g)	Conf.
3012.1	Dx.	949	575	580	330	500 - 800	13.880	1
3012.2	Sx.	949	575	580	330	500 - 800	13.880	1
3013.1	Dx.	1109	885	700	400	801 - 1.200	17.960	1
3013.2	Sx.	1109	885	700	400	801 - 1.200	17.960	1



GUIDE INFERIORI - BOTTOM GUIDES

Guida a pavimento in acciaio zincato con asole, 6mt. di lunghezza

Art. 3011

Galvanized steel bottom guide with slot, 6mt length

Guide au sol en acier zingué avec feinte, 6mt de longueur

Guía para suelo de acero cincado con tuerca, 6mt larga

Bodenführungsschiene aus verzinktem Stahl mit Knopflochern

NOVAGUIDE®

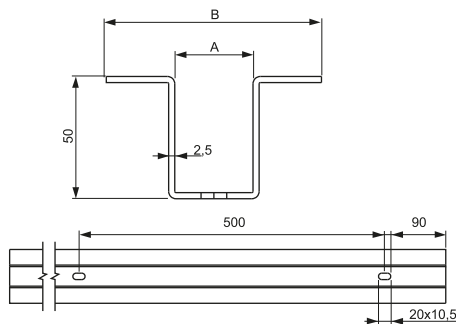

Materiale: Acciaio zincato

Art.	A	B	Peso(g/m)	Conf.
3011/32	32	88	3.400	1
3011/42	42	98	3.600	1



## Art. 3026

## Profilo zincato a cementare filo pavimento di 6mt

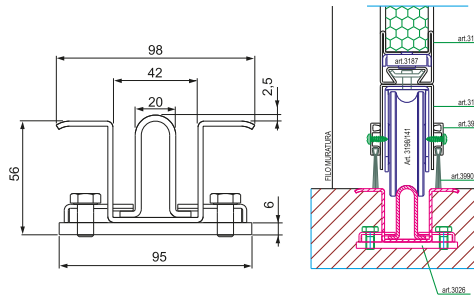

- Galvanized profile 6 mt. long to be cemented into floor
- Profil zingué 6 mt. à cimenter au sol
- Guía en acero zincado a cementar bajo el nivel del suelo
- Verzinktes Führungsprofil zu zementieren, 6 Meter lang

Materiale: Acciaio zincato

Art.	Peso(g/m)	Conf.
3026	6.550	20

**NOVAGUIDE®**

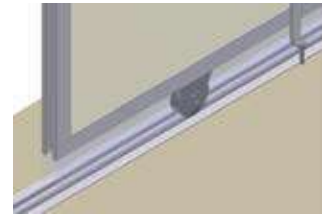

## Art. 3090

## Guida a cementare in acciaio zincato

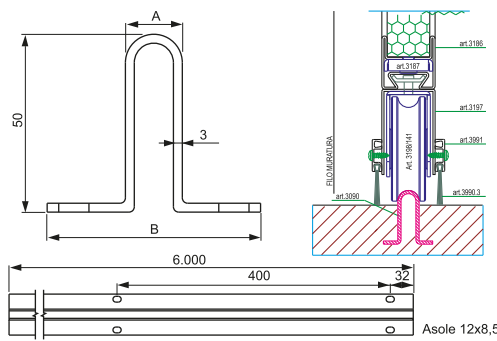

- Galvanized steel guide to be cemented
- Rail en acier zingué à cimenter
- Guía en acero cincado para cementar
- Führungsprofil aus verzinktem Stahl zu zementieren

Materiale: Acciaio zincato

Art.	A	B	L	Peso/m	Conf.	Imb.
3090/20.3	20	60	3mt.	3.260	10	40
3090/20.6	20	60	6mt.	3.260	10	40

**NOVAGUIDE®**

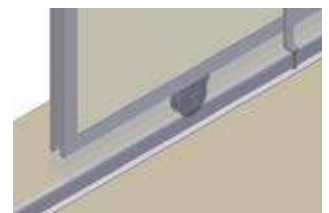

## Art. 3094 - 3096

## Guida a cementare in acciaio zincato

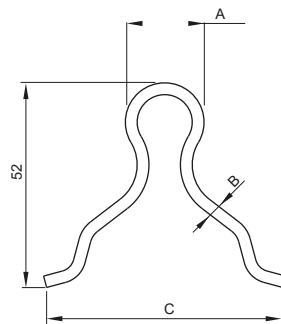

- Galvanized steel guide to be cemented
- Rail en acier zingué à cimenter
- Guía en acero cincado para cementar
- Führungsschiene aus verzinktem Stahl zum Zementierung

Materiale: Acciaio zincato

Art.	A	B	C	L/m	Peso/m	Conf.	Imb.
3094/20.3	20	3	60	3	2.870	10	40
3094/20.6	20	3	60	6	2.870	10	40
3096/20.3	20	4	60	3	3.830	10	40
3096/20.6	20	4	60	6	3.830	10	40

**NOVAGUIDE®**

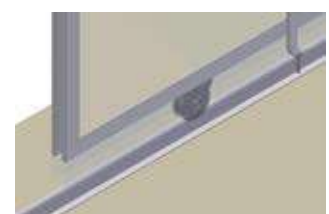

Perno di giunzione per guida a cementare Art. 3094

Art. 3095

UK Junction pin for guide to be cemented  
Item 3094

FR Pivot de jonction pour guide à cimenter  
Modèle 3094

ES Eje de unión para guía a empotrar  
Mod. 3094

DE Verbindungsstift für Laufschiene  
Art. 3084, zu zementieren

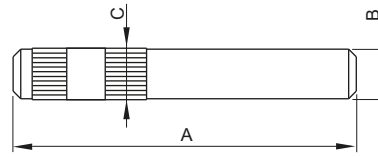

Materiale: Acciaio zincato

Art.	A	B	C	Peso	Conf.
3095	64	13	13,5	188	25

NOVAGUIDE®



Guida ad avvitare in acciaio zincato

Art. 3091

UK Galvanized steel guide to be screwed

FR Rail en acier zingué à visser

ES Guía en acero cincado para atornillar

DE Führungsprofil aus verzinktem  
Stahl zu schrauben

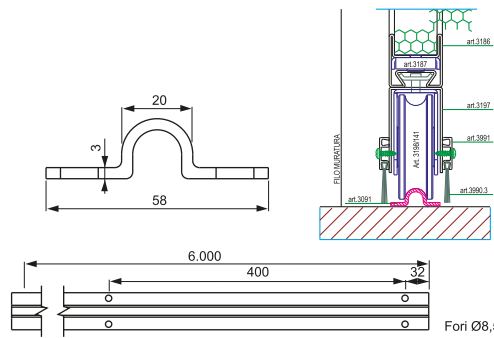

Materiale: Acciaio zincato

Art.	L/m	Peso/m	Conf.	Imb.
3091/20.3	3	1.600	10	40
3091/20.6	6	1.600	10	40

NOVAGUIDE®

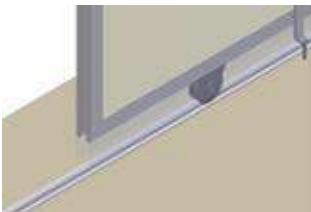

Guida ad avvitare in acciaio zincato

Art. 3097

UK Galvanized steel guide to be  
screwed

FR Rail en acier zingué à visser

ES Guía en acero cincado para  
atornillar

DE Führungsschiene aus verzinktem Stahl  
zum Schrauben

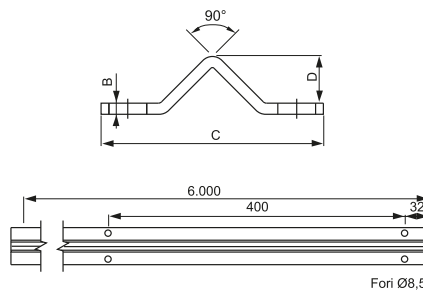

Materiale: Acciaio Zincato

Art.	B	C	D	L(m)	Peso/m	Conf.	Imb.
3097/V3	2,5	50	13	3	1.160	10	40
3097/V6	2,5	50	13	6	1.160	10	40

NOVAGUIDE®

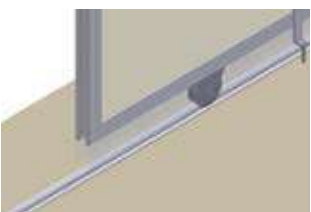

## CARRELLI E CERNIERE PER PORTONI A LIBRO - GUIDE ART. 3088 - 3183 - Sistema a Coda di Rondine SLIDERS AND HINGES FOR FOLDING GATES - GUIDES ART. 3088 - 3183 - Swallowtail System

### Art. 3600 Carrello c.le a 4 cuscinetti Ø65 c/perno e cerniera verniciata ad attacco interno con piastrina

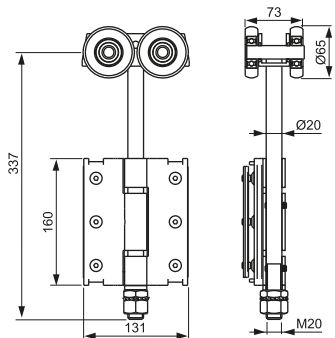

- Four wheels Ø65 ball bearing central hanger with pin and central black painted hinge dovetail fastening
- Chariot avec 4 roulements Ø65 avec pivot et charnière centrale vernie noire avec assemblage à queue d'aronde
- Roldana central con 4 rodamientos Ø65 con pernio y bisagra barnizada negra con placa para fijación interna
- Zentrale 4 Lager-Stahlrollapparat Ø65 mit Bolzen und lackiertes Scharnier mit Innenverschraubung und Platte

Materiale: Acciaio verniciato

Art.	Var.	Peso(g)	Conf.
3600.1	Acciaio	3.950	2
3600.2	Nylon	3.130	2

**NOVAGUIDE**



### Art. 3601 - 3602 - 3904 Carrello terminale a 4 cuscinetti Ø65 c/perno e cerniera verniciata ad attacco interno

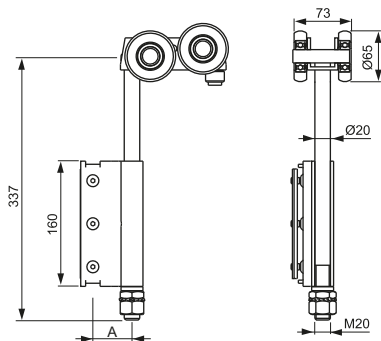

- Four wheels Ø65 ball bearing end hanger with pin and black painted hinge dovetail fastening
- Chariot avec 4 roulements Ø65 avec pivot et charnière d'extrémité vernie noire avec assemblage à queue d'aronde
- Roldana lateral con 4 rodamientos Ø65 con pernio y bisagra ultima barnizada negra con placa para fijación interna
- Seitliche 4 Lager-Stahlrollapparat Ø65 mit Bolzen und lackiertes Scharnier mit Innenverschraubung

Materiale: Acciaio verniciato

Art.	Var.	Ala	A	Peso(g)	Conf.
3601.1	Acciaio	Piegata	50	3.610	2
3601.2	Nylon	Piegata	50	2.760	2
3602.1	Acciaio	Piatta	50	3.610	2
3602.2	Nylon	Piatta	50	2.760	2
3904	Acciaio	Piatta	88	3.830	2

**NOVAGUIDE**



### Art. 3650 Cerniera centrale verniciata nera ad attacco interno con piastrina

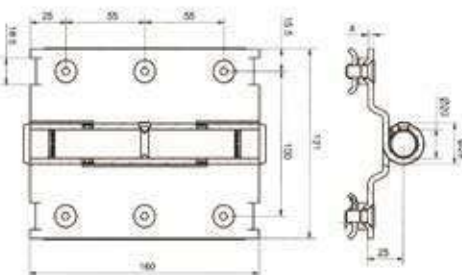

- Dovetail fastening black painted central hinge
- Charnière centrale vernie noire avec assemblage à queue d'aronde
- Bisagra central barnizada negra con placa para fijación interna
- Zentrale schwarz lackiertes Scharnier mit Innenverschraubung und Platte

Materiale: Acciaio verniciato

Art.	Peso(g)	Conf.
3650	1.470	10

**NOVAGUIDE**



**Cerniera centrale verniciata nera ad attacco interno con cuscinetto**

Art. 3651

Dovetail fastening black painted central hinge with ball bearing for bottom guide

Charnière centrale vernie noire avec assemblage à queue d'aronde avec roulement pour guide inférieure

Bisagra central barnizada negra con placa para fijación interna con rodamiento

Zentrale schwarz lackiertes Scharnier mit Innenverschraubung und Lager

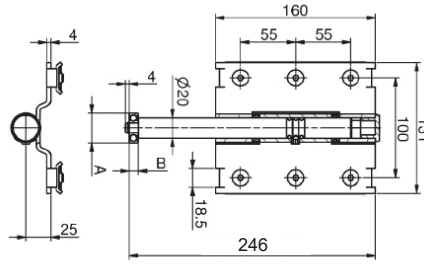

Regolazione ± 6mm



Materiale: Acciaio verniciato

**NOVAGUIDE**



Art.	A	B	Peso(g)	Conf.
3651/20	20 perno	-	1.570	6
3651/30	30	9	1.690	6
3651/40	40	12	1.740	6

**Cerniera terminale verniciata nera ad attacco interno con cuscinetto**

Art. 3652

Dovetail fastening black painted end hinge with ball bearing bottom guide

Charnière d'extrémité vernie noir avec assemblage à queue d'aronde avec roulement pour guide inférieure

Bisagra lateral barnizada negra con placa para fijación interna con rodamiento

Schwarz lackiertes Endscharnier mit Innenverschraubung und Lager

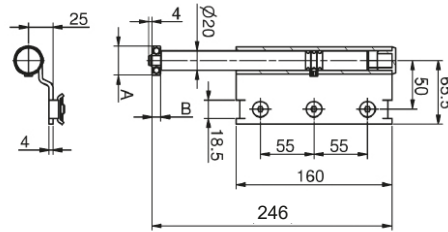

Regolazione ± 6mm



Materiale: Acciaio verniciato

**NOVAGUIDE**



Art.	A	B	Peso(g)	Conf.
3652/30	30	9	1.350	10
3652/40	40	12	1.400	10

**Cerniera terminale verniciata nera ad attacco interno con cuscinetto**

Art. 3653 - 3952 - 3903

Dovetail fastening black painted end hinge with ball bearing bottom guide

Charnière d'extrémité vernie noir avec assemblage à queue d'aronde avec roulement pour ouverture centrale du portail

Bisagra lateral barnizada negra con placa para fijación interna con rodamiento

Schwarz lackiertes Endscharnier mit Innenverschraubung und Lager

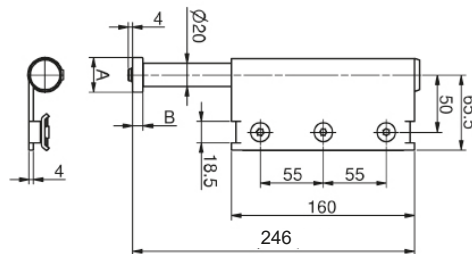

Regolazione ± 6mm



Materiale: Acciaio verniciato

**NOVAGUIDE**



Art.	A	B	Peso(g)	Conf.
3653/30	30	9	1.350	10
3653/40	40	12	1.400	10
3952.1	20-perno	-	1.220	12
3903	20-perno	-	850	4

Cerniera in alluminio

## CARRELLI E CERNIERE PER PORTONI A LIBRO - GUIDE ART. 3088 - 3183 - Sistema ad Avvitare SLIDERS AND HINGES FOR FOLDING GATES - GUIDES ART. 3088 - 3183 - Screwing System

### Art. 3700 Carrello centrale a 4 cuscinetti Ø65 con perno e cerniera verniciata nera ad avvitare



Materiale: Acciaio verniciato  
Cover copertura: Nylon

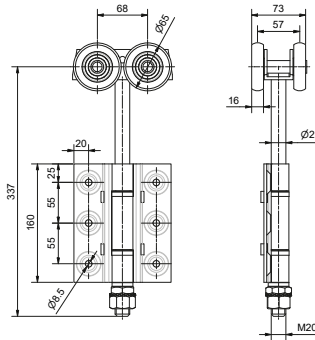

- Four wheels Ø65 ball bearing central hanger with pin and black painted central hinge to be screwed
- Chariot avec 4 roulements Ø65 avec pivot et charnière centrale vernie noire à visser
- Roldana central con 4 rodamientos Ø65 con pernio y bisagra barnizada negra a atornillar
- Zentral 4Läger-Rollenapparat Ø 65 mit tift und schwarz lackiertes Schamier zum Schrauben

Art.	Var.	Peso(g)	Conf.
3700.1	Acciaio	3.750	2
3700.2	Nylon	2.930	2



### Art. 3701 - 3702 Carrello terminale a 4 cuscinetti Ø65 c/perno e cerniera verniciata ad avv. c/battuta o piana



Materiale: Acciaio verniciato  
Cover copertura: Nylon

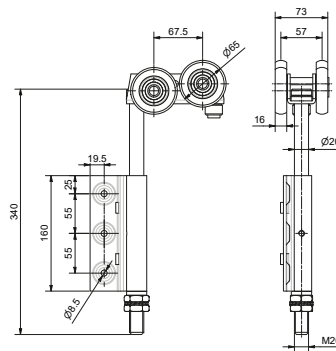

- Four wheels Ø65 ball bearing end hanger with pin and end flat or shoulder black painted hinge to be screwed
- Chariot avec 4 roulements Ø65 avec pivot et charnière d'extrémité vernie noire à visser, plane ou avec feuillure
- Roldana lateral con 4 rodamientos Ø65 con pernio y bisagra barnizada negra a atornillar plana o con paliza
- Seitliche 4Läger-Rollenapparat Ø 65 mit Stift und schwarz lackiertes Schamier zum Schrauben mit Anschlag oder flach

Art.	Cerniera	Var.	Peso(g)	Conf.
3701.1	Con battuta	Acciaio	3.510	2
3701.2	Con battuta	Nylon	2.690	2
3702.1	Piana	Acciaio	3.510	2
3702.2	Piana	Nylon	2.690	2



### Art. 3750 Cerniera centrale verniciata nera ad avvitare



Materiale: Acciaio verniciato  
Cover copertura: Nylon

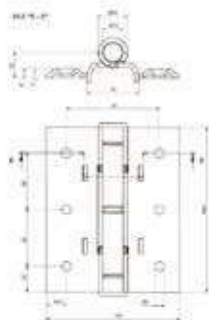

- Black painted central hinge to be screwed
- Charnière centrale à visser vernie noire
- Bisagra central barnizada negra a atornillar
- Zentrale schwarz lackiertes Schamier zum Schrauben

Art.	Peso(g)	Conf.
3750	1.250	8







## CARRELLI E CERNIERE PER PORTONI A LIBRO - GUIDE ART. 3088 - 3183 - Sistema a Saldare SLIDERS AND HINGES FOR FOLDING GATES - GUIDES ART. 3088 - 3183 - Welding System

Art. 3800

Carrello centrale a 4 cuscinetti Ø65 con perno e cerniera a saldare

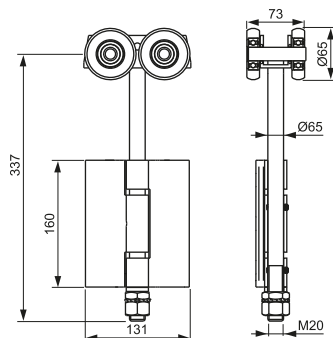

Four wheels Ø65 ball bearing central hanger with pin and central hinge to be welded

Chariot avec 4 roulements Ø65 avec pivot et charnière centrale à souder

Roldana central con 4 rodamientos Ø65 con perno y bisagra a soldar

Zentraler 4Läger-Rollenapparat Ø 65 mit Stift und Scharnier zum Schweißen

Materiale: Acciaio grezzo

Art.	Var.	Peso(g)	Conf.
3800.1	Acciaio	3.720	2
3800.2	Nylon	2.900	2



Art. 3801

Carrello terminale a 4 cuscinetti Ø65 con perno e cerniera a saldare

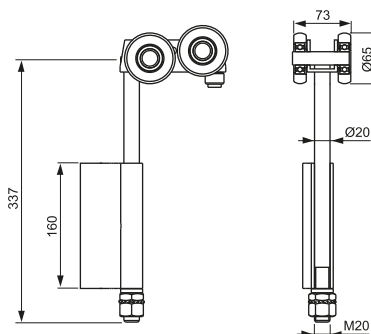

Four wheels Ø65 ball bearing end hanger with pin and end hinge to be welded

Chariot avec 4 roulements Ø65 avec pivot et charnière d'extrémité à souder

Roldana lateral con 4 rodamientos Ø65 con perno y bisagra a soldar

Seitlicher 4Läger-Rollenapparat Ø 65 mit Stift und Scharnier zum Schweißen

Materiale: Acciaio grezzo

Art.	Var.	Peso(g)	Conf.
3801.1	Acciaio	3.440	2
3801.2	Nylon	2.620	2



Art. 3850

Cerniera centrale a saldare

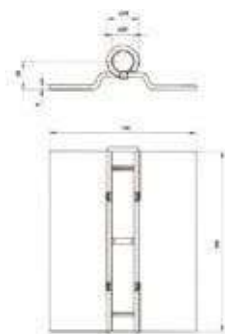

Central hinge to be welded

Charnière centrale à souder

Bisagra central a soldar

Zentrale Scharnier zum Schweißen

Materiale: Acciaio grezzo

Art.	Peso(g)	Conf.
3850	1.250	10





**Cerniera centrale a saldare con cuscinetto**

Art. 3851

 Central hinge to be welded screwed with ball bearing for bottom guide

 Charnière centrale à souder avec roulement pour guide inférieure

 Bisagra central a soldar con rodamiento

 Zentrale Scharnier mit Lager, zum Schweißen

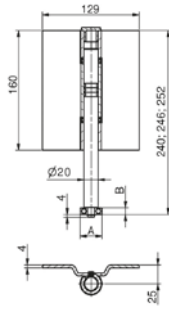

Materiale: Acciaio grezzo





Art.	A	B	Peso(g)	Conf.
3851/30	30	9	1.530	6
3851/40	40	12	1.580	6

**Cerniera terminale a saldare con cuscinetto**

Art. 3852

 End hinge to be welded with ball bearing for bottom guide

 Charnière d'extrémité à souder avec roulement pour guide inférieure

 Bisagra lateral a soldar con rodamiento

 Seitliche Scharnier mit Lager, zum Schweißen

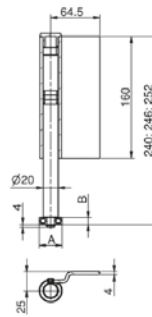

Materiale: Acciaio grezzo



Art.	A	B	Peso(g)	Conf.
3852/30	30	9	1.230	10
3852/40	40	12	1.280	10

## CARRELLI E CERNIERE PER PORTONI A LIBRO - GUIDA ART. 50 - Sistema a Coda di Rondine SLIDERS AND HINGES FOR FOLDING GATES - GUIDE ART. 50 - Swallowtail System

### Art. 3907 Carrello c.le a 4 cuscinetti Ø44 c/perno e cerniera verniciata ad attacco interno con piastrina



Materiale: Acciaio verniciato

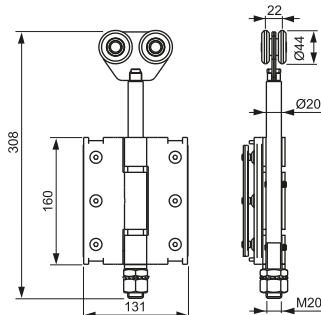

Four wheels Ø44 ball bearing central hanger with pin and central black painted hinge dovetail fastening

Chariot avec 4 roulements Ø44 avec pivot et charnière centrale vernie noire avec assemblage à queue d'aronde

Roldana central con 4 rodamientos Ø44 con pernio y bisagra barnizada negra con placa para fijación interna

Zentraler 4 Läger-Stahlrollapparat Ø44 mit Bolzen und lackiertes Scharnier mit Innenverschraubung und Platte

Art.	Peso(g)	Conf.
3907	2.420	2

**NOVAGUIDE®**

### Art. 3906 Carrello terminale a 4 cuscinetti Ø44 c/perno e cerniera verniciata nera ad attacco interno



Materiale: Acciaio verniciato

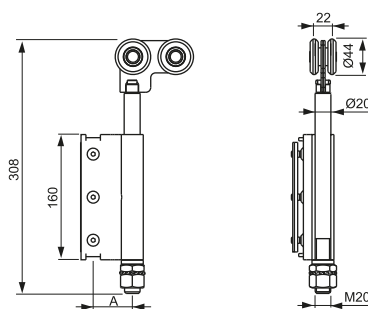

Four wheels Ø44 ball bearing end hanger with pin and black painted hinge dovetail fastening

Chariot avec 4 roulements Ø44 avec pivot et charnière d'extrémité vernie noire avec assemblage à queue d'aronde

Roldana lateral con 4 rodamientos Ø44 con pernio y bisagra ultima barnizada negra con placa para fijación interna

4Läger-seitlicher Rollapparat Ø 44 mit Bolzen und lackiertes Scharnier mit Innenverschraubung

Art.	A	Peso(g)	Conf.
3906/1	88	2.230	2
3906/2	50	2.040	2

**NOVAGUIDE®**

### Art. 3908 Carrello terminale a 2 cuscinetti Ø44 c/perno e cerniera verniciata nera ad attacco interno



Materiale: Acciaio verniciato

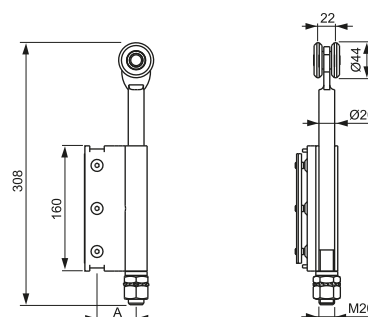

Two wheels Ø44 ball bearing end hanger with pin and black painted hinge dovetail fastening

Chariot avec 2 roulements Ø44 avec pivot et charnière d'extrémité vernie noire avec assemblage à queue d'aronde

Roldana lateral con 2 rodamientos Ø44 con pernio y bisagra ultima barnizada negra con placa para fijación interna

2Läger-seitlicher Rollapparat Ø44 mit Bolzen und lackiertes Scharnier mit Innenverschraubung

Art.	A	Peso(g)	Conf.
3908/1	88	1.950	2
3908/2	50	1.760	2





**NOVAGUIDE®**

**N.B:** La cerniera centrale e quelle inferiori le trovate a pag. 180 - 181, da Art. 3650 ad Art. 3653  
Central and bottom hinge can be found on pages 180 - 181, Art. 3650 to Art. 3653

**CARRELLI E CERNIERE PER PORTONI A LIBRO - GUIDA ART. 50 - Sistema ad Avvitare**  
**SLIDERS AND HINGES FOR FOLDING GATES - GUIDE ART. 50 - Screwing System**

**Carrello centrale a 4 cuscinetti ø 44 c/perno e cerniera verniciata ad avvitare**

**Art. 3304**

-  *Four wheel ø 44 ball bearing central hanger w/pin and black painted hinge to be screwed*
-  *Chariot centrale avec 4 roulements ø 44 avec pivot et charnière d'extrémité vernie noire à visser*
-  *Carro central con 4 rodamientos de ø 44 con pernio y bisagra, a tornillar*
-  *Zentraler Rollenapparat mit vier Ø 44 Lägern, Stift und lackierte Scharniere zum Einschrauben*

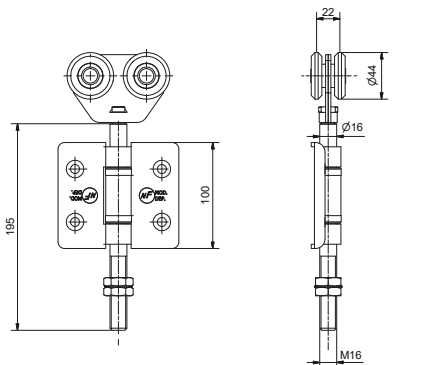





Materiale: Acciaio verniciato

Art.	Peso(g)	Conf.
3304	1.287	2



**Carrello terminale a 4 cuscinetti ø 44 c/perno e cerniera verniciata ad avvitare**

**Art. 3305**

-  *Four wheel ø 44 ball bearing end hanger w/pin and black painted hinge to be screwed*
-  *Chariot d'extrémité avec 4 roulements ø 44 avec pivot et charnière vernie noire à visser*
-  *Carro lateral con 4 rodamientos de ø 44 con pernio y bisagra, a tornillar*
-  *Seitlicher Rollenapparat mit vier Ø 44 Lägern, Stift und lackierte Scharniere zum Einschrauben*

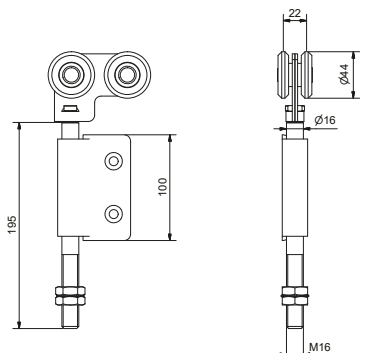





Materiale: Acciaio verniciato

Art.	Peso(g)	Conf.
3305	1.200	2



**Carrello terminale a 2cuscinetti ø 44 c/perno e cerniera verniciata ad avvitare**

**Art. 3306**

-  *Two wheel ø 44 ball bearing end hanger w/pin and black painted hinge to be screwed*
-  *Chariot d'extrémité avec 2 roulements ø 44 avec pivot et charnière vernie noire à visser*
-  *Carro lateral con 2 rodamientos de ø 44 con pernio y bisagra, a tornillar*
-  *Seitlicher Rollenapparat mit zwei Ø 44 Lägern, Stift und lackierte Scharniere zum Einschrauben*

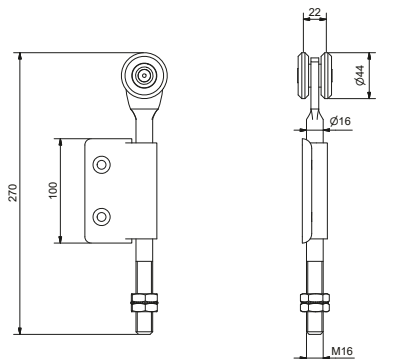

Materiale: Acciaio verniciato

Art.	Peso(g)	Conf.
3306	1.000	2

Art. 3100

## Cerniera centrale in acciaio verniciata nera ad avvitare



Materiale: Acciaio Verniciato

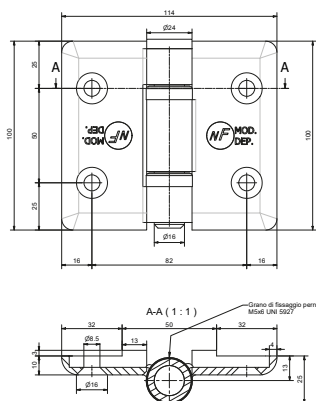

Black painted central hinge to be screwed

Charnière centrale à visser vernie noire

Bisagra central de acero barnizada negra a atornillar

Zentrale schwarz lackiertes Stahlscharnier. Zum Schrauben



Art.  
3100

Peso(g) 680  
Conf. 10  
Imb. 20

Art. 3103

## Cerniera centrale verniciata nera ad avvitare con cuscinetto o rullo



Materiale: Acciaio Verniciato

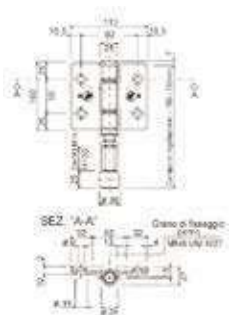

Black painted central or end hinge brass roller/ball bearing for bottom guide

Charnière centrale, d'extrémité vernie noire avec rouleau/roulement pour guide inférieur

Bisagra central y lateral con rodillo/rodamiento para guía inferior

Zentrale Scharnier, schwarz lackierte mit Lager oder Führungsrolle, zum Schrauben



Art.

Var.

Var.

Peso(g)

Conf.

Imb.

3103/30.4	Con battuta	Cuscinetto	940	6	12
3103/30.5	Con battuta	Oliva ottone	940	6	12

Art. 3303 - 3403

## Cerniera terminale verniciata nera ad avvitare con cuscinetto o rullo



Materiale: Acciaio Verniciato

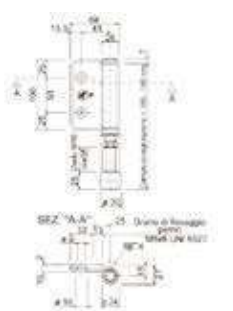

Black painted central or end hinge brass roller/ball bearing for bottom guide

Charnière centrale, d'extrémité vernie noire avec rouleau/roulement pour guide inférieur

Bisagra central y lateral con rodillo/rodamiento para guía inferior

Seitliche Scharnier, schwarz lackierte mit Lager oder Führungsrolle, zum Schrauben

Art.

Var.

Var.

Peso(g)





Conf.

Imb.

3303/30.4	Con battuta	Cuscinetto	760	6	12
3303/30.5	Con battuta	Oliva ottone	810	6	12
3403/30.4	Piana	Cuscinetto	760	6	12
3403/30.5	Piana	Oliva ottone	810	6	12

**CARRELLI E CERNIERE PER PORTONI A LIBRO - GUIDA ART. 3910 - Sistema a Coda di Rondine**  
**SLIDERS AND HINGES FOR FOLDING GATES - GUIDE ART. 3910 - Swallowtail System**

**Carrello universale con 3 cuscinetti in nylon completo di perno e cerniera per portoni 2+2** Art. 3901

-  *Three ball bearing end hanger in nylon with pin and black painted hinge for 2+2 doors configuration*
-  *Chariot avec 3 roulements en nylon et charnière en acier verni noir pour configuration du portail 2+2*
-  *Roldana terminal con 3 rodamientos en nylon con pernio y bisagra barnizada negra para porton 2+2*
-  *Universal 3Läger-Rollenapparat aus Nylon mit Stift und Schamier für Tore 2+2*

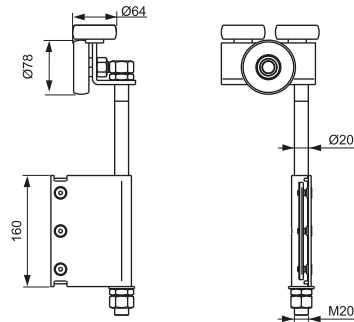

Materiale: Acciaio verniciato





Art.	Peso(g)	Conf.
3901.1	3.200	4

**NOVAGUIDE®**



**CARRELLI PER PORTONI SCORREVOLI - GUIDE ART. 3088 - 3183 - Sistema a Coda di Rondine**  
**SLIDERS AND HINGES FOR SLIDING GATES - GUIDES ART. 3088 - 3183 - Swallowtail System**

**Carrello centrale con 4 cuscinetti Ø65 completo di perno filettato per portoni scorrevoli** Art. 86

-  *Four wheels Ø65 ball bearing central hanger with threaded pin for sliding doors*
-  *Chariot avec 4 roulements Ø65 avec pivot fileté pour porte accordéon*
-  *Roldana central con 4 rodamientos Ø65 con pernio con rosca para correderas*
-  *Zentraler 4Läger-Rollenapparat Ø 65 mit Gewindestift für Schiebtore*

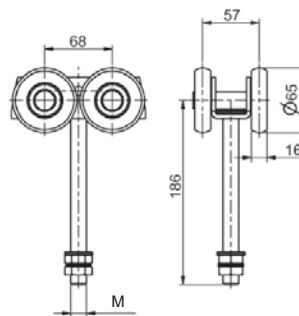

Materiale: Acciaio zincato





Art.	Var.	M	Peso(g)	Conf.
86/16.1	Acciaio	16	2.820	4
86/16.2	Nylon	16	2.000	4
86/20.1	Acciaio	20	2.820	4
86/20.2	Nylon	20	2.000	4

**NOVAGUIDE®**



**Tassello regolabile di fissaggio M16**

Art. 3190/2

-  *Adjustable fixing dowel M16*
-  *Goujon réglable de fixation M16*
-  *Placa regulable de fijación M16*
-  *Einstellbare Befestigungsstift M16*

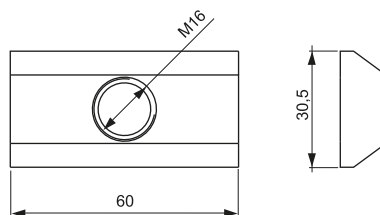

Materiale: Acciaio Zincato

Art.	Peso(g)	Conf.
3190/2	320	12

**NOVAGUIDE®**





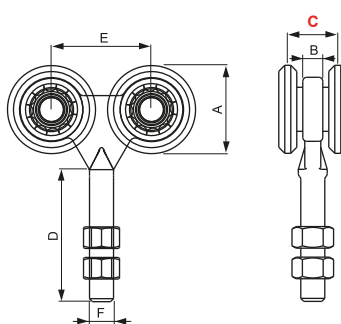

## CARRELLI PER PORTONI SCORREVOLI - GUIDA ART. 50 - Sistema a Coda di Rondine SLIDERS AND HINGES FOR SLIDING GATES - GUIDE ART. 50 - Swallowtail System

Art. 52/S

Carrello a 4 ruote in acciaio cementato zincato



-  4 wheels cemented galvanized steel hanger
-  Chariot en acier zingué à 4 galets
-  Carro en acero cincado cementado con 4 roldanas
-  4-KugellagerRollapparat, aus zementiertem und verzinktem Stahl





Materiale: Acciaio zincato

Art.	Sistema	A	B	C	D	E	F	Peso(g)	Conf.
52/S		44	8	22	64	48	M12	650	25

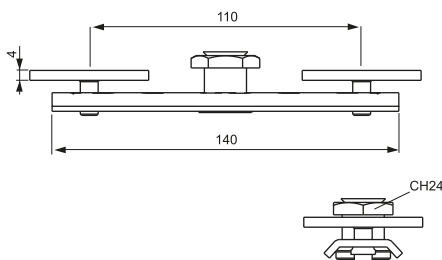
Art. 3190/1

Supporto regolabile di fissaggio M12 con piastra



-  Adjustable fixing support M12 with plate
-  Support réglable de fixation M12 avec platine
-  Soporte regulable de fijación M12 con placa
-  Einstellbare Befestigungsplatte M12

Materiale: Acciaio Zincato





Art.	Peso(g)	Conf.
3190/1	476	12

**NOVAGUIDE**



Profilo zincato per porta pedonale e porta vetro, 6mt. di lunghezza

Art. 3089 - 3024

-  Galvanized profile for pedestrian door, 6mt length
-  Profil zingué pour porte piéton, 6mt. de longueur
-  Perfil cincado puerta peatonal, 6mt largo
-  Verzinktes Profil für Gehür und Glasür, 6 mt. Lang

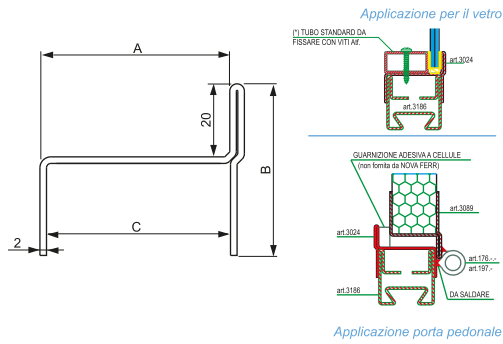

Materiale: Acciaio zincato



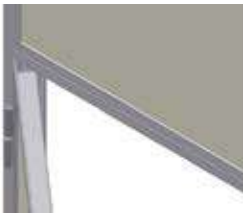

Art.	Tipo Prof.	A	B	C	Peso(g/m)	Conf.
3089	telaio porta	42	60	40,4	2.420	2
3024	Vetro	52	47	50,4	2.420	2

NOVAGUIDE®



Profilo zincato 80x50 per portoni scorrevoli appesi

Art. 3197

-  Galvanized profile 80x50
-  Profil en acier zingué
-  Perfil de acero cincado 80x50
-  Verzinktes Profil 80x50

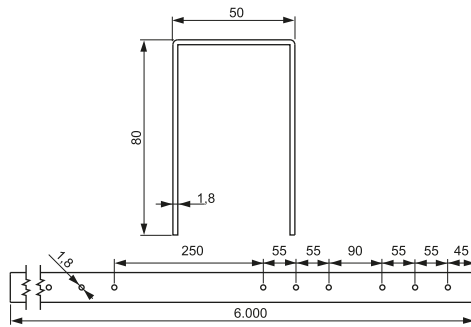

Materiale: Acciaio zincato





Art.	Peso(g/m)	Conf.
3197	3.200	20

NOVAGUIDE®



Cuscinetto in nylon con piastra

Art. 3016 - 3199/3

-  Nylon wheel with ball bearing and plate
-  Roulement en nylon avec platine
-  Rueda de nylon con placa
-  Lager aus Nylon mit Platte

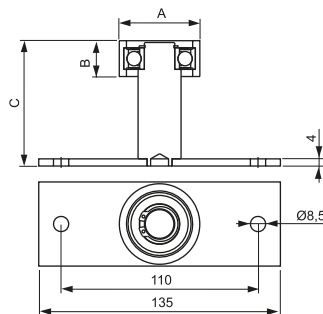

Materiale: Acciaio Zincato

Art.	A	B	C	Peso(g)	Conf.
3016.6	63	20	43	420	12
3016.7	70	19	42,5	430	12
3016.8	78	22	44	470	12
3199/3	45	20	70	470	12

NOVAGUIDE®





## Art. 124



Materiale: Acciaio verniciato

Art.	A	B	C	D	E	F	Peso	Conf.
124/20	240	200	117	30	70	47	430	6
124/25	290	250	167	30	70	47	515	6
124/30	340	300	215	30	70	47	600	6

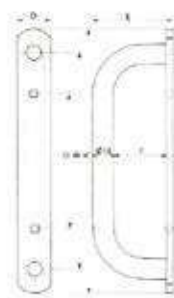

## Maniglione a due pieghe

- Handle with two bends
- Poigné avec deux courbes
- Manillón recto de acero barnizado negro
- 2 Falte Rohrförmiger Stossgriff

**NOVAGUIDE®**



## Art. 125



Materiale: Acciaio verniciato

Art.	A	B	C	D	E	F	G	Peso	Conf.
125/20	240	200	117	118	45	25	30	450	6
125/25	290	250	167	118	45	25	30	530	6
125/30	340	300	215	118	45	25	30	700	6

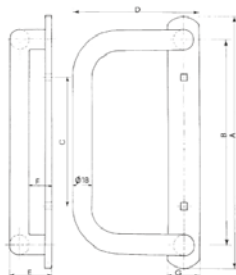

## Maniglione a quattro pieghe

- Handle with four bends
- Poigné avec quatre courbes
- Manillón desplazado de acero barnizado negro
- 4 Falte Rohrförmiger Stossgriff

**NOVAGUIDE®**



## Art. 3553



Materiale: Alluminio verniciato

Art.	Var.	Peso	Conf.	Imb
3553/1	con sticker	190	10	50
3553/2	senza sticker	180	10	50
3553/3	solo sticker	10	1.000	-

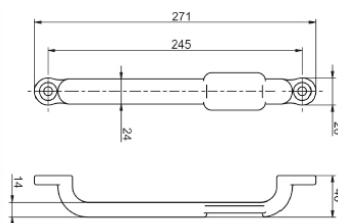

## Maniglione in alluminio con e senza logo





- Aluminium handle with and without logo
- Fermeture en aluminium avec et sans logo
- Manillón en aluminio con o sin pegatina
- Stossgriff aus Aluminium, mit und ohne Aufkleber

**NOVAGUIDE®**



Squadrette attacco piantone

Art. 3921

-  *Fastening square plates*
-  *Equerres de fixation*
-  *Escuadras de fijación*
-  *Winkel Halterung für Pfostenbefestigung*

**NOVAGUIDE®**

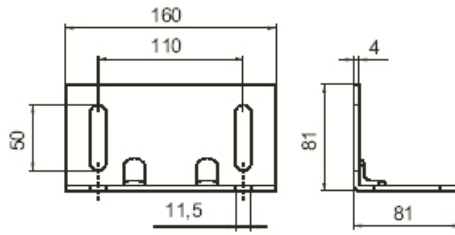





Materiale: Acciaio zincato

Art.  
3921

Peso(g)	Conf.
700	25

Squadrette attacco piantone

Art. 3926

-  *Fastening square plates*
-  *Equerres de fixation*
-  *Escuadras de fijación*
-  *Winkel Halterung für Pfostenbefestigung*

**NOVAGUIDE®**

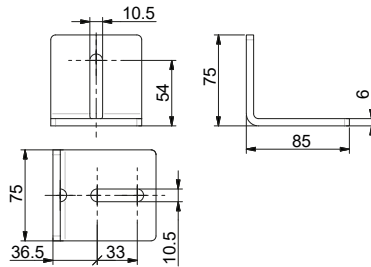





Materiale: Acciaio zincato

Art.  
3926

Peso(g)	Conf.
470	25

Piastra di supporto e fissaggio del profilo 3186 alla muratura

Art. 3922

-  *Plate for support and fixing of profile 3186 for column of door 2+2*
-  *Platine de support et fixation profil 3186 pour jambe de portail 2+2*
-  *Placa de fijación perfil 3086 para el pilar por porton 2+2*
-  *Unterstützungplatte um Profil 3186 am Pfosten zu befestigen für Tore 2+2*

**NOVAGUIDE®**

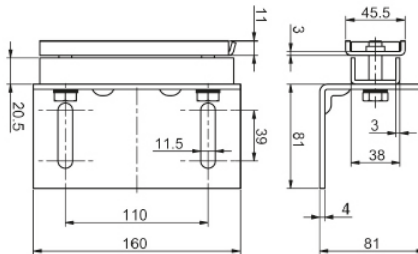

Materiale: Acciaio zincato

Art.  
3922

Peso(g)	Conf.
1.190	8

Placca di spessoramento

Art. 3925

-  *Spacer*
-  *Plaque a caler*
-  *Placa de suplemento*
-  *Blechstückprofil*

**NOVAGUIDE®**

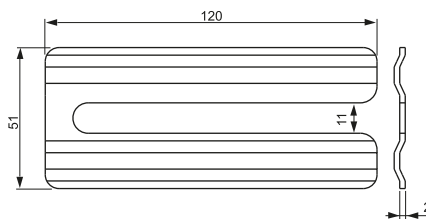

Materiale: Acciaio zincato

Art.  
3925

Peso(g)	Conf.
115	30

## Art. 3050

## Cariglione in acciaio

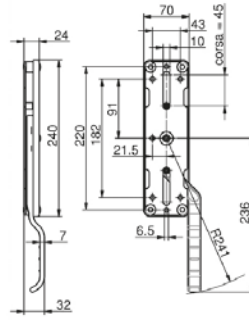

Materiale: Acciaio verniciato Acciaio Zincato

Art.	Var.	Mano	Peso(g)	Conf.
3050/1.1	Zincato	Dx	1.200	8
3050/2.1	Zincato	Sx	1.200	8
3050/1.2	Verniciato Nero	Dx	1.200	8
3050/2.2	Verniciato Nero	Sx	1.200	8

- Steel lock
- Fermeture en acier
- Cremona de acero
- Treibriegel aus Stahl

**NOVAGUIDE®**



## Art. 3051

## Rullo guida aste cariglione

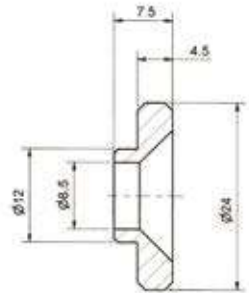

Materiale: Acciaio Zincato

Art.	Peso(g)	Conf.
3051	12	100

- Roller for bar lock steel lock
- Rouleau pour barre de fermeture
- Rodillo guía asta cremona
- Führungsrolle für Verbindungsstange

**NOVAGUIDE®**



## Art. 3052

## Asta per cariglione in acciaio zincato

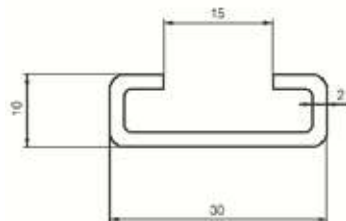

Materiale: Acciaio Zincato

Art.	L(m)	Peso(g)	Conf.	Imb.
3052/60	6	840/mt	5	60
3052/45	4,5	840/mt	5	60
3052/15	1,5	840/mt	10	-





- Galvanized steel bar for steel lock
- Barre pour fermeture en acier zingué
- Asta para cremona en acero cincado
- Verbindungsstange aus verzinktem Stahl

**NOVAGUIDE®**



Perno terminale per asta cariglione

Art. 3053

-  Terminal pin for bar lock
-  Pivot terminale pour barre de fermeture
-  Pernio terminal para asta cremona
-  Endstift für Verbindungsstange

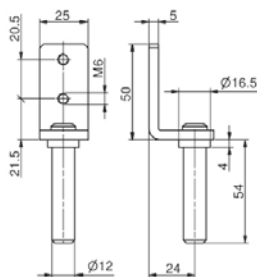

Materiale: Acciaio Zincato

Art.  
3053





Peso(g) 120  
Conf. 20

NOVAGUIDE®



Incontro a pavimento per asta cariglione

Art. 3976

-  Floor strike plate for bar lock
-  Butée au sol pour barre de fermeture
-  Tope de acero para asta cremona
-  Bodenaufschu für Verbindungsstange

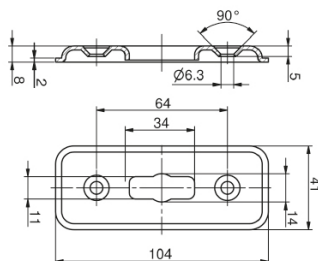

Materiale: Acciaio verniciato

Art.  
3976





Peso(g) 70  
Conf. 20

NOVAGUIDE®



Incontro superiore asta cariglione verniciato con piastrina

Art. 3022

-  Painted upper strike plate for bar lock with plate
-  Butée superior pour barre de fermeture vernie avec platine
-  Tope superior para asta cremona barnizado con placa
-  Deckeaufschu für Verbindungsstange

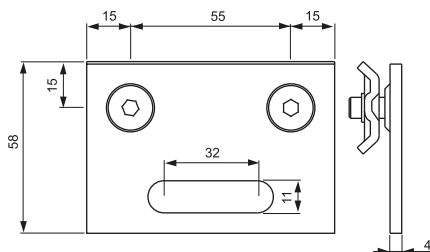

Materiale: Acciaio verniciato

Art.  
3022

Peso(g) 210  
Conf. 4

NOVAGUIDE®



## Art. 3975

## Incontro per portoni a libro

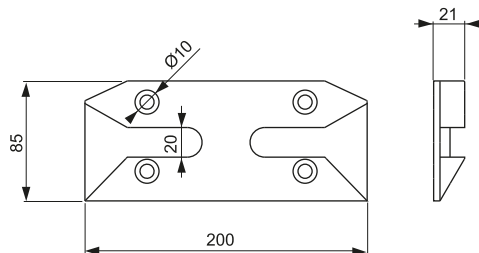

Plastic strike plate for multifolding doors

Butée du bas en matière plastique pour portes accordéon

Encuentro para portón a libro

Auflaufschu für Falttore

Materiale: Nylon

Art.	Peso(g)	Conf.
3975	270	12

**NOVAGUIDE®**



## Art. 3977

## Incontro a pavimento in alluminio

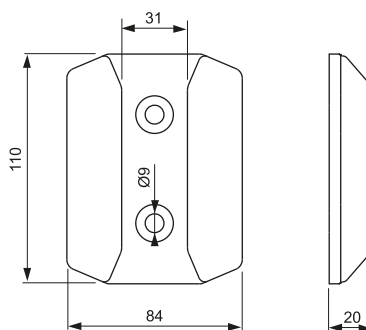

Aluminium floor strike plate for bar lock

Butée au sol pour barre de fermeture en aluminium

Encuentro en aluminio para el piso

Bodenaufaufschu aus Aluminium

Materiale: Alluminio Verniciato

Art.	Peso(g)	Conf.
3977	130	4



## Art. 3005

## Incontro per portoni a libro

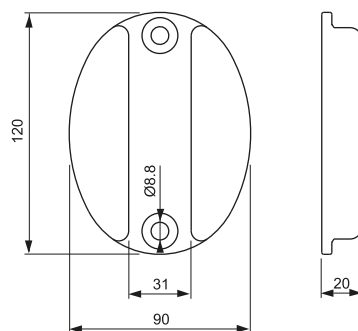

Steel strike plate for sliding doors

Butée du bas en acier zingué pour portes accordéon

Encuentro para portón a libro





Auflaufschu für Falttore

Materiale: Acciaio Zincato

Art.	Peso(g)	Conf.
3005	820	12



**Blocchetto di giunzione pannelli** Art. 3021

-  Connection insert for panels
-  Cale d'union pour panneaux
-  Sistema de unión
-  Verbindungsstück für Paneele

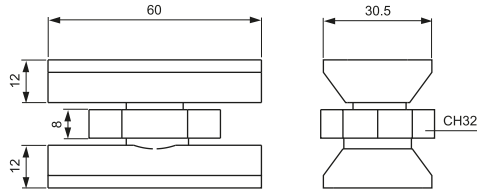





Materiale: Acciaio Zincato

Art.	Peso(g)	Conf.
3021	340	12

**NOVAGUIDE®**



**Chiave di chiusura** Art. 3023

-  Tightening key
-  Clef de serrage
-  Llave especial para atornillar
-  Schlüssel

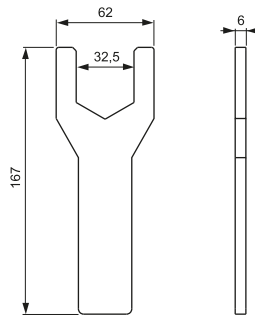





Materiale: Acciaio grezzo

Art.	Peso(g)	Conf.
3023	210	1

**NOVAGUIDE®**



**Ruota Art. 140-141 completa di piastrina e contropiastra per fissaggio** Art. 3198

-  Wheel Art.140-141 complete fixing plates
-  Galet Art. 140-141 complet de plaques de fixation
-  Rueda Art. 140-141 completa de placas de union
-  Rad Art.140-141 mit Platte und Gegenplatte für Befestigung

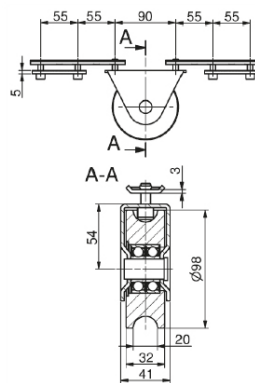

Materiale: Acciaio Zincato

Art.	Tipo Gola	Cuscinetti	Peso(g)	Conf.
3198/141	U	2	2.255	4
3198/140	Y	2	2.355	4

**NOVAGUIDE®**



## Art. 3990

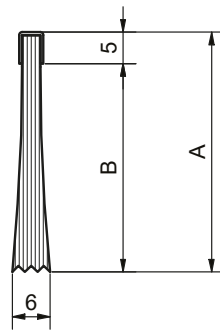

Materiale: Acciaio + fibre PPL

Art.	A	B	Peso(g)	Conf.
3990.1	25	20	124/mt.	10
3990.2	32	27	136/mt.	10
3990.3	38	33	143/mt.	10
3990.4	50	45	160/mt.	10

## Spazzolino, 3mt lunghezza

-  *Brush, 3mt lenght*
-  *Brosse, 3mt de longueur*
-  *Escobilla, 3mt larga*
-  *Bürste, 3 Meter lang*

**NOVAGUIDE®**





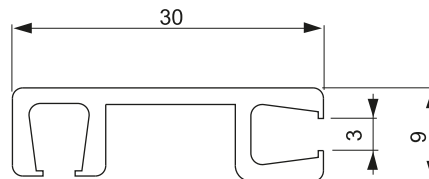
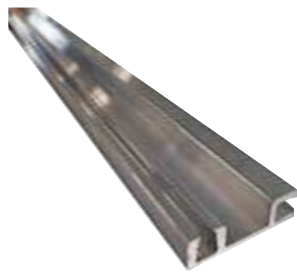

## Art. 3991



Materiale: Alluminio

Art.	Peso(g)	Conf.
3991	278/mt.	10



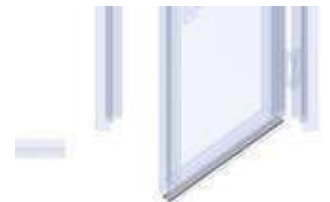

## Profilo porta spazzolino in alluminio 3mt di lunghezza

-  *Aluminium holding brush profile, 3 mt lenght*
-  *Guide porte brosse en aluminium, 3mt longueur*
-  *Guía potea escobilla en aluminio, 3mt larga*
-  *Aufnahmeprofil Bürstendichtung aus Aluminium für Bürste, 3 Meter lang*

**NOVAGUIDE®**



**Rullo guida anticaduta Ø35** Art. 3199/1

-  Antifall guidance wheel diam.35
-  Galet de guidage antichute diam. 35
-  Rodillo guía anticaída diám. 35
-  Fallschutzführungsrolle Ø 35

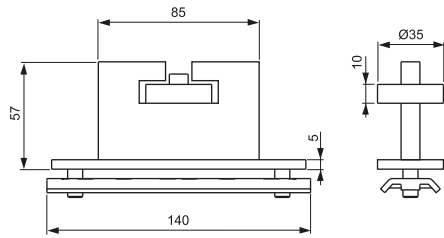



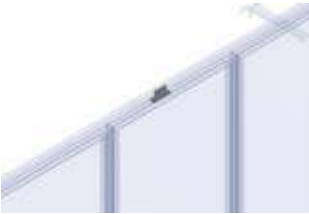

Materiale: Acciaio Zincato

Art.	Peso(g)	Conf.
3199/1	1.500	4

**NOVAGUIDE®**



**Rullo guida anticaduta Ø82** Art. 3199/2

-  Antifall guidance wheel diam.82
-  Galet de guidage antichute diam. 82
-  Rodillo guía anticaída diám. 82
-  Fallschutzführungsrolle Ø 82

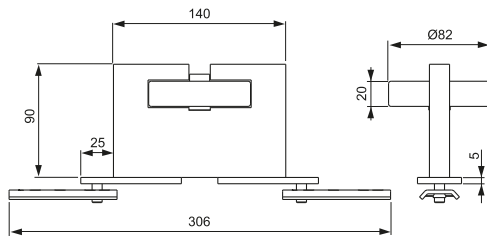



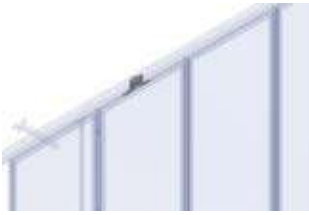

Materiale: Acciaio Zincato

Art.	Peso(g)	Conf.
3199/2	2.340	2

**NOVAGUIDE®**



**Gancio di fissaggio per pareti ventilate** Art. 6600

-  Fixing hook for ventilated walls
-  Crochet de fixation pour façades ventilées
-  Gancho de fijación para revestimiento de fachada
-  Befestigungshaken für hinterlüftete Fassaden

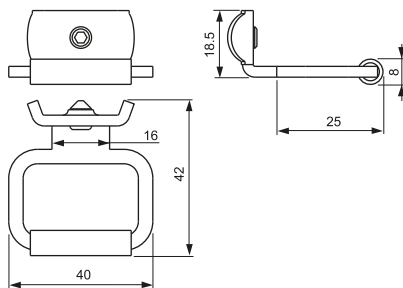

Materiale: Acciaio Zincato

Art.	Peso(g)	Conf.
6600	187	24

**NOVAGUIDE®**







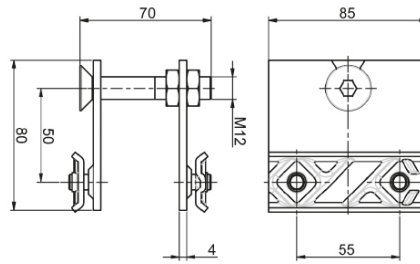

## Art. 3924

## Gancio di blocco verniciato nero per anta spezzata



-  *Black painted locking hook for pedestrian door*
-  *Crochet de blocage verni noir pour porte piétons*
-  *Gancho barnizado negro para puerta peatonal*
-  *schwarz lackierter Sperrhaken für geteilt Blatt*

Materiale: Acciaio verniciato

Art.	Peso(g)	Conf.
3924	460	10





**NOVAGUIDE®**

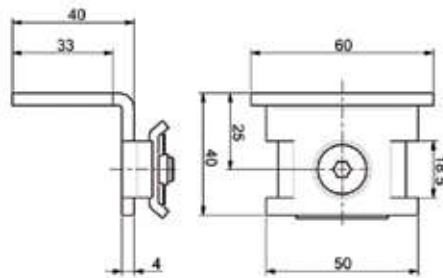

## Art. 3923

## Incontro per scrocco verniciato nero



-  *Black pointed meeting point for spring latch*
-  *Rencontre verni noir pour pêne*
-  *Cerrajero barnizado negro para resbalon*
-  *Schwarz lackierter Auflaufshuch für Riegel*

Materiale: Acciaio verniciato





Art.	Peso(g)	Conf.
3923	155	10

**NOVAGUIDE®**



**Guarnizione centrale per telaio anta Art. 3186**

**Art. 3980**

-  *Central seal rubber for profile Art. 3186*
-  *Protection centrale en gomme pour profil Art. 3186*
-  *Protección central para perfil hoja Art. 3186*
-  *Zentrale Gummidichtung für Rahmen/Torblatt Art. 3186*

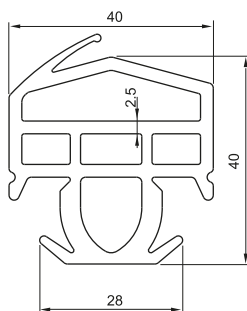

Rotolo 25mt.

Materiale: EPDM





Art.	Peso(g)	Conf.
3980	780/mt.	25mt.

**NOVAGUIDE®**



**Guarnizione con battuta**

**Art. 3984**

-  *Seal rubber with shoulder*
-  *Protection en gomme avec feuillure*
-  *Protección central con canto*
-  *Gummidichtung mit Anschlag*

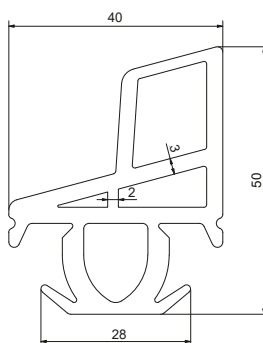

Rotolo 25mt.

Materiale: EPDM



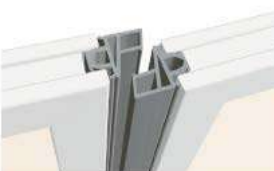

Art.	Peso(g)	Conf.
3984	718/mt	25mt.

**NOVAGUIDE®**



**Guarnizione terminale per telaio anta Art. 3186**

**Art. 3981**

-  *End seal rubber for profile Art. 3186*
-  *Protection d'extrémité en gomme pour profil Art. 3186*
-  *Protección lateral para perfil hoja Art. 3186*
-  *Seitliche Gummidichtung für Rahmen/Torblatt Art. 3186*

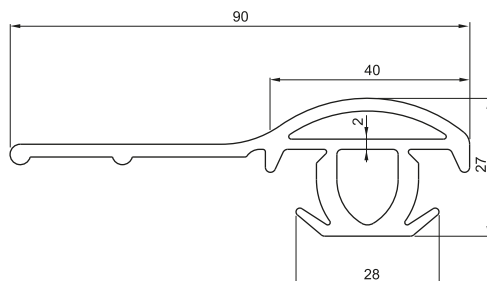

Rotolo 25mt.

Materiale: EPDM

Art.	Peso(g)	Conf.
3981	741/mt.	25mt.

**NOVAGUIDE®**



## Art. 3985



Rotolo 25mt.

Materiale: EPDM

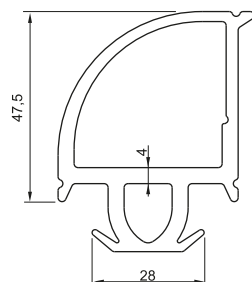

Art.	Peso(g)	Conf.
3985	870/mt	25mt.

## Guarnizione per angolare

- Seal rubber for angular
- Protection en gomme pour angulaire
- Protección en goma para angular
- Gummidichtung für Winkel

**NOVAGUIDE®**



## Art. 3986



Rotolo 100mt.

Materiale: EPDM

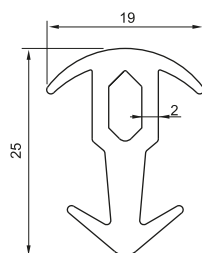

Art.	Peso(g)	Conf.
3986	190/mt.	100mt.

## Guarnizione di giunzione pannelli

- Seal rubber for panels junction
- Protection en gomme pour jonction de panneaux
- Protección en goma para unión de paneles
- Gummidichtung für Paneelesverbindung

**NOVAGUIDE®**



## Art. 3987



Rotolo 25mt.

Materiale: EPDM

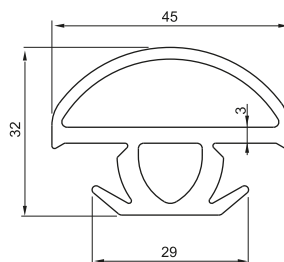

Art.	Peso(g)	Conf.
3987	525/mt.	25mt.

## Guarnizione terminale piana





- End plain seal rubber for profile Art. 3186
- Protection plane d'extrémité en gomme pour profil 3186
- Protección llana lateral para perfil 3186
- Seitliche Flachgummiverbindung

**NOVAGUIDE®**



**Guarnizione centrale per telaio anta**

Art. 3982

-  Central seal rubber
-  Protection centrale en gomme
-  Protección central para perfil hoja
-  Zentrale Gummidichtung für Rahmen/Torblatt

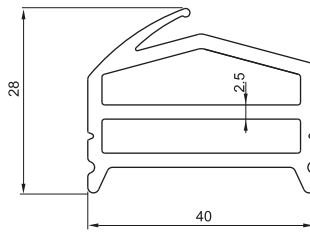

Rotolo 25mt.

Materiale: EPDM





Art.	Peso(g)	Conf.
3982	497/mt.	25mt.

**NOVAGUIDE®**



**Guarnizione terminale per oblò pannello con vetro 5/8**

Art. 3983

-  Seal rubber for the panel window with glass 5/8
-  Protection en gomme pour hublot de porte accordéon avec vitre 5/8
-  Protección para portilla del panel con vidrio 5/8
-  Seitliche Gummidichtung für Paneelfenster 5/8

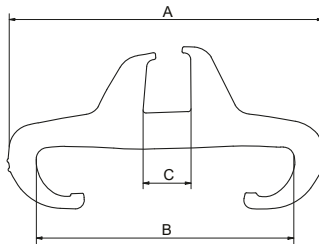

Rotolo 25mt.

Materiale: EPDM

Art.	A	B	C	Peso(g)	Conf.
3983/1	55	45	8,4	700 /mt.	25mt.





**NOVAGUIDE®**

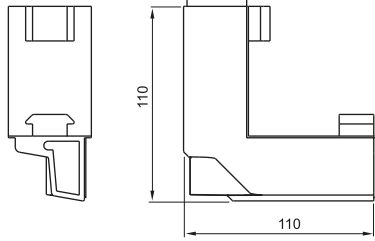

Art. 3988/1

Incontro angolare sx per anta spezzata in gomma EPDM



-  *Finishing EPDM rubber angle*
-  *Angle de finition en caoutchouc EPDM*
-  *Ángulo de acabado en goma EPDM*
-  *EPDM Links-Gummiwinkel für geteiltes Torblatt*

Materiale: EPDM

Art.	Peso(g)	Conf.
3988/1	100	4





**NOVAGUIDE**

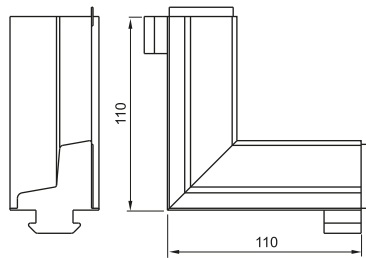

Art. 3988/2

Incontro angolare dx o sx per guarnizione di cornice in gomma EPDM



-  *Finishing EPDM rubber angle*
-  *Angle de finition en caoutchouc EPDM*
-  *Ángulo de acabado en goma EPDM*
-  *EPDM Links oder Rechts-Gummiwinkel für Rahmendichtung*

Materiale: EPDM

Art.	Peso(g)	Conf.
3988/2	100	4





**NOVAGUIDE**

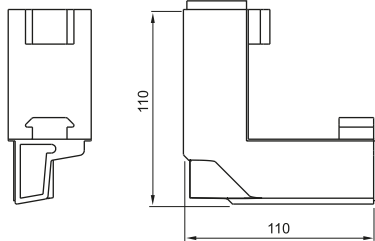

Art. 3988/3

Incontro angolare dx per anta spezzata in gomma EPDM



-  *Finishing EPDM rubber angle*
-  *Angle de finition en caoutchouc EPDM*
-  *Ángulo de acabado en goma EPDM*
-  *EPDM Rechts-Gummiwinkel für geteiltes Torblatt*

Materiale: EPDM

Art.	Peso(g)	Conf.
3988/3	100	4





**NOVAGUIDE**

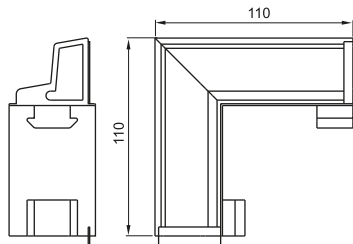

Art. 3988/4

Angolo in battuta dx o sx in gomma EPDM



-  *Finishing EPDM rubber angle*
-  *Angle de finition en caoutchouc EPDM*
-  *Ángulo de acabado en goma EPDM*
-  *EPDM Links oder Rechts-Gummiwinkelanschlag*

Materiale: EPDM

Art.	Peso(g)	Conf.
3988/4	100	4

**NOVAGUIDE**



Staffa per fissaggio a soffitto/pavimento per pareti mobili

Art. 3194

 Bracket for ceiling and floor fixing of mobile walls

 Support pour plafond ou sol fixation pour cloison mobile

 Soporte de fijacion al techo o al piso para paredes moviles

 Decke/Boden Befestigungswinkel für Stellwände

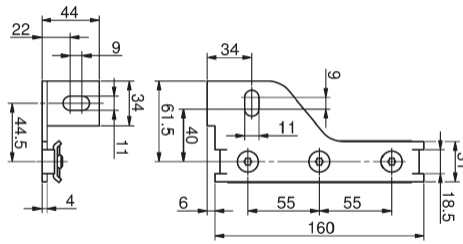

Materiale: Acciaio Zincato

Peso(g) Conf.(2pz)

820 20

Art.  
3194

NOVAGUIDE®



Staffa di giunzione per pareti mobili

Art. 3195

 Joint plate for mobile walls

 Plaque de jonction pour cloison mobile

 Placa de fijación para paredes móviles

 Verbindungswinkel für Stellwände

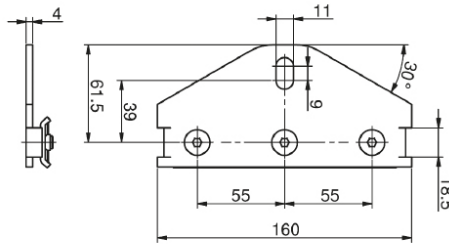

Materiale: Acciaio verniciato

Peso(g) Conf.(2pz)

830 20

Art.  
3195

NOVAGUIDE®



Angolare di fissaggio

Art. 3196

 Angular fixing plate

 Plaque angulaire de fixation

 Placa angular de unión

 eckige Winkelbefestigung

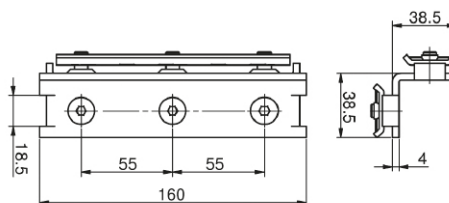

Materiale: Acciaio verniciato

Peso(g) Conf.

590 20

Art.  
3196

NOVAGUIDE®



## Art. 3191

## Piastrina e contropiastra per fissaggio interno al profilo Art. 3186

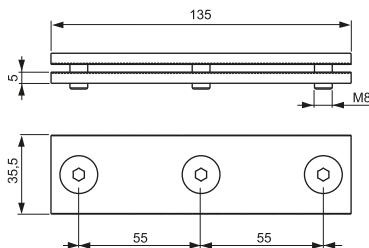

Fixing plate and plaque for profile Art. 3186

Plaque et contre platine de fixation pour profil Art. 3186

Placa y platina de fijación para perfil Art. 3186

Befestigungsplatte und Gegenplatte für Innenverschraubung des Profils Art. 3186

Materiale: Acciaio Zincato

Art.	Peso(g)	Conf.
3191	370	20

**NOVAGUIDE**



## Art. 3192

## Piastrina e contropiastra a coda di rondine

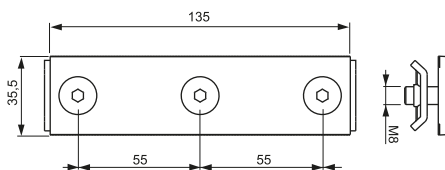

Plate and dovetail plate

Plaque et contre platine a queue d'aronde

Placa y platina de fijación a cola de golondrina

Schwalbenschwanz Befestigungsplatte und Gegenplatte

Materiale: Acciaio Zincato

Art.	Peso(g)	Conf.
3192	290	20

**NOVAGUIDE**



## Art. 3193

## Piastrina a coda di rondine per fissaggio a profilo Art. 3186 - 3188

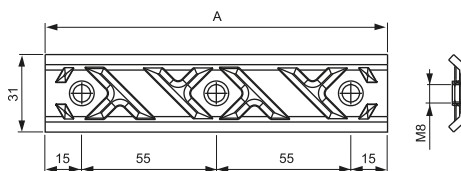

Swallowtail plate for profile Art. 3186 - 3188

Platine à queue d'aronde pour profil Art. 3186 - 3188

Platina a cola de golondrina para perfil Art. 3186 - 3188

Schwalbenschwanz Befestigungsplatte für Profil Art. 3186 - 3188

Materiale: Acciaio Zincato

Art.	n.fori	A	Peso(g)	Conf.
3193.1	1	30	0,06	50
3193.2	2	85	0,100	50
3193.3	3	140	0,160	50





**NOVAGUIDE**



ACCESSORI PER MOTORIZZAZIONE

Tendicatena per catena

Art. 3117



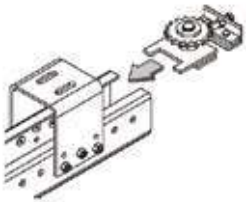
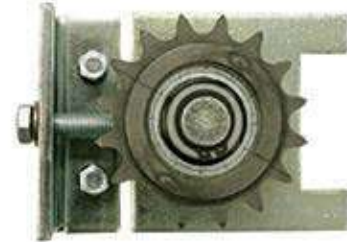
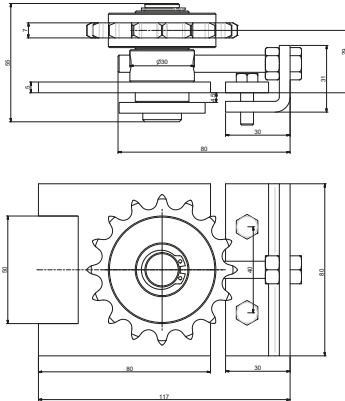

-  *Adjuster for chain in horizontal configuration*
-  *Tendeur de chaine en configuration horizontale*
-  *Tensor cadena horizontal*
-  *Obere Kettenbefestigung*



Art.	Peso(g)	Conf.
3117	840	2

Attacco della catena configurazione orizzontale

Art. 3118



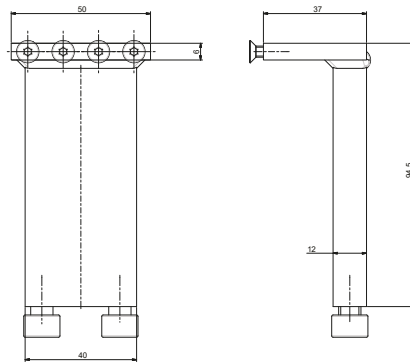

-  *Chain fastening in horizontal configuration*
-  *Attelage de la chaine en configuration horizontale*
-  *Unión cuerpo carro a cadena horizontal*
-  *Kettenbefestigung in waagenrechten Darstellung*



Art.	Peso(g)	Conf.
3118	840	4

Catena per motore 1/2" x 5/16"

Art. 3129

-  *Chain for motor with dimension 1/2" x 5/16"*
-  *Chaîne pour moteur avec dimension 1/2" x 5/16"*
-  *Cadena para automatismo paso 1/2" x 5/16"*
-  *Motor-Kette 1/2" x 5/16"*

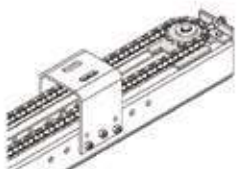

Art.	Peso(g)	Conf.
3129	674/m	5 mt



## Art. 3127

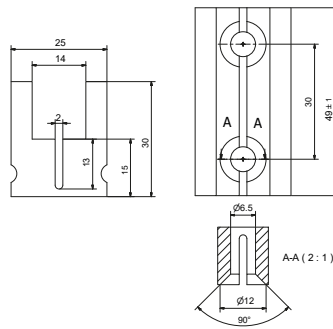

## Supporto in plastica per catena

- Plastic support for chain
- Support en plastique pour chaîne
- Soporte cadena en plástico
- Kunststoffhalter für Kette

Art.  
3127

Peso(g) 30  
Conf. 8



## Art. 3017

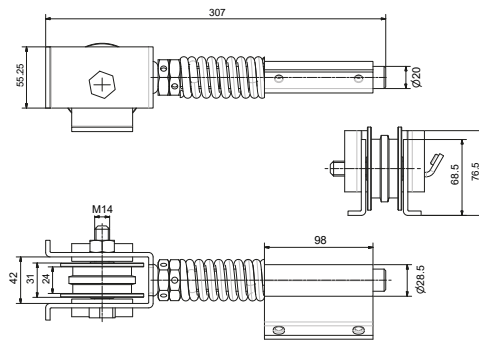

## Tendicatena

- Chain adjuster
- Tendeur de chaîne
- Tensor para cadena
- Kettenspanner

Art.  
3017

Peso(g) 2650  
Conf. 2  
Imb. 4

## Art. 3018- 3019



Art. 3018

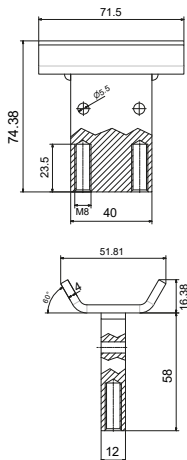

Art. 3019

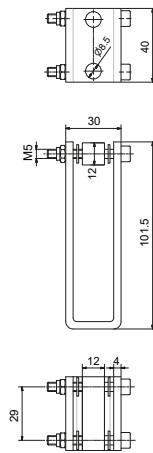

## Attacco inferiore superiore

- Joint device for end hanger to bottom (3018) upper (3019) chain
- Dispositif de jonction chariot a partie inférieure (3018) supérieure (3019) de chaîne
- Ataque inferior (3018) superior (3019) de cadena de carril terminal
- Obere (3018) und untere (3019) Kettenbefestigung

Art.  
3018  
3019

Peso(g) 350  
Conf. 10  
Imb. 40

Peso(g) 275  
Conf. 10  
Imb. 20

Art. 3018



Art. 3019



## Manuale tecnico portoni sistema NOVAGUIDE®



# NOVAGUIDE®

- IT** Lo strumento fondamentale per la costruzione dei portoni a libro e dei portoni scorrevoli è il MANUALE TECNICO della Nova-Ferr srl. Le schede tecniche racchiuse nel manuale danno le informazioni necessarie per il corretto assemblaggio degli accessori e taglio dei profili appartenenti al nostro sistema NOVAGUIDE®.  
Richiedi il manuale NOVAGUIDE® scrivendo al nostro ufficio tecnico [ufftecnico@novaferr.com](mailto:ufftecnico@novaferr.com)
- UK** The most important tool for the construction of foldable doors and sliding doors is the Nova-Ferr srl TECHNICAL GUIDE. The data sheets enclosed in the manual give the necessary information for a correct assembling of the accessories and a right cutting of the profiles needed for our NOVAGUIDE® system.  
Request the NOVAGUIDE® manual by writing to our technical office [ufftecnico@novaferr.com](mailto:ufftecnico@novaferr.com)
- ES** El medio fundamental para la construcción de las puertas plegables y de las puertas correderas es el MANUAL TÉCNICO de Nova-Ferr srl. Las fichas técnicas incluidas en el manual dan la información necesaria para el correcto montaje de los accesorios y el corte de los perfiles utilizados en nuestro sistema NOVAGUIDE®.  
Solicite el manual NOVAGUIDE® escribiendo a nuestro departamento técnico [ufftecnico@novaferr.com](mailto:ufftecnico@novaferr.com)
- FR** L'outil le plus important pour la construction des portes pliantes et des portes coulissantes est le MANUEL TECHNIQUE de Nova-Ferr srl. Les fiches techniques contenues dans le manuel donnent les informations nécessaires pour l'assemblage correct des accessoires et pour la coupe des profils appartenant à notre système NOVAGUIDE®.  
Demandez le manuel NOVAGUIDE® en écrivant à notre bureau technique [ufftecnico@novaferr.com](mailto:ufftecnico@novaferr.com)
- DE** Das grundlegende Hilfsmittel für den Bau von Faltdore sowie Schiebetore ist das TECHNISCHE HANDBUCH von Nova-Ferr srl. Die technischen Datenblätter, die im Handbuch enthalten sind, geben die notwendigen Informationen für eine korrekte Montage des Zubehörs und der Profile unseres NOVAGUIDE®-Systems.  
Fordern Sie bitte das NOVAGUIDE® Handbuch an, indem Sie an unsere technische Abteilung [ufftecnico@novaferr.com](mailto:ufftecnico@novaferr.com) schreiben.
- RU** Самым важным инструментом для конструкции складных и раздвижных дверей является ТЕХНИЧЕСКОЕ РУКОВОДСТВО Nova-Ferr srl. Прилагаемые к руководству спецификации дают необходимую информацию для правильной сборки аксессуаров и правильной нарезки профилей, необходимых для нашей системы NOVAGUIDE®.  
Вы можете запросить руководство NOVAGUIDE®, написав в наш технический офис [ufftecnico@novaferr.com](mailto:ufftecnico@novaferr.com)

## Certificazione sistema NOVAGUIDE®



- IT** È possibile ottenere la certificazione CE in cascading per i portoni realizzati con il nostro sistema NOVAGUIDE®. Richiedi indicazioni e la documentazione necessaria all'ufficio tecnico Nova-Ferr [ufftecnico@novaferr.com](mailto:ufftecnico@novaferr.com)
- UK** It is possible to obtain the CE certification in cascading for the doors made with our NOVAGUIDE® system. Request information and documentation from the technical office Nova-Ferr [ufftecnico@novaferr.com](mailto:ufftecnico@novaferr.com)

**N.B. INDICARE CON UNA X LA TIPOLOGIA DI PORTONE DI VOSTRO INTERESSE**

**1**



**SCORREVOLI**



**APPOGGIATO**



**APPESO**

**ATTENZIONE:**  
Il numero di moduli può variare in base alle misure di L

L = LUCE PASSAGGIO (mm) .....  
H = LUCE PASSAGGIO (mm) .....  
PORTA PEDONALE  
 SI  NO

**2**



ANTA UNICA  
(pannelli maschio/femmina)



A SEQUENZA



MODULARE

**3**



SINGOLA RACCOLTA



CHIUSURA SX  
(vista da interno edificio)



CHIUSURA DX  
(vista da interno edificio)

**4**

N° DI PORTONI DI QUESTA TIPOLOGIA RICHIESTI: .....

**DATI CLIENTE**

COGNOME O AZIENDA .....  
MAIL .....  
TELEFONO .....

**ATTENZIONE:** Lo schema delle tipologie di posa e di presa misure è riportato nella pagina successiva di questo documento

**Modulo Richiesta Preventivo Accessori Portoni Industriali**



**NOVA-FERR srl**  
L'innovazione la chiave del successo

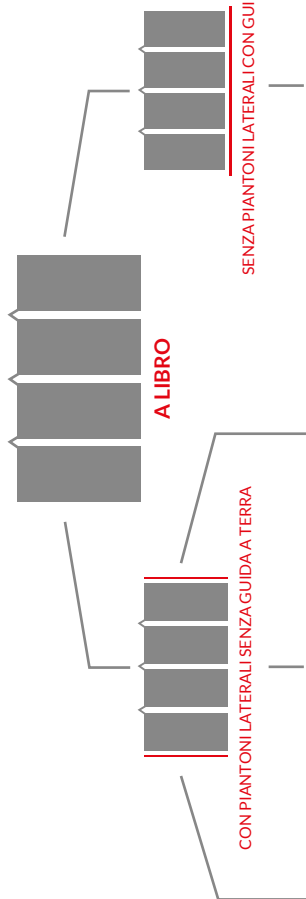

**IN LUCE**

**PARZIALMENTE FUORI LUCE**

**FUORI LUCE**

L = LUCE PASSAGGIO (mm) .....  
H = LUCE PASSAGGIO (mm) .....  
N° ANTE A DX (VISTE DA INTERNO EDIFICIO) .....  
N° ANTE A SX (VISTE DA INTERNO EDIFICIO) .....

L = LUCE PASSAGGIO (mm) .....  
H = LUCE PASSAGGIO (mm) .....  
N° ANTE A DX (VISTE DA INTERNO EDIFICIO) .....  
N° ANTE A SX (VISTE DA INTERNO EDIFICIO) .....

L = LUCE PASSAGGIO (mm) .....  
H = LUCE PASSAGGIO (mm) .....  
N° ANTE A DX (VISTE DA INTERNO EDIFICIO) .....  
N° ANTE A SX (VISTE DA INTERNO EDIFICIO) .....

APERTURA  
 90°  180°  
SOLUZIONE\* vedi pag 2  
STANDARD ELEGANT  
PORTA PEDONALE  
 SI  NO  
ANTA PORTA PEDONALE  
.....  
(Indicare il numero di anta partendo da SX vista interno edificio)

APERTURA  
 90°  180°  
SOLUZIONE\* vedi pag 2  
STANDARD ELEGANT  
PORTA PEDONALE  
 SI  NO  
ANTA PORTA PEDONALE  
.....  
(Indicare il numero di anta partendo da SX vista interno edificio)

APERTURA  
 90°  180°  
SOLUZIONE\* vedi pag 2  
STANDARD ELEGANT  
PORTA PEDONALE  
 SI  NO  
ANTA PORTA PEDONALE  
.....  
(Indicare il numero di anta partendo da SX vista interno edificio)

N° DI PORTONI DI QUESTA TIPOLOGIA RICHIESTI: .....

Per ricevere un preventivo compila questo modulo ed invialo alla mail [marketing@novaferr.com](mailto:marketing@novaferr.com)

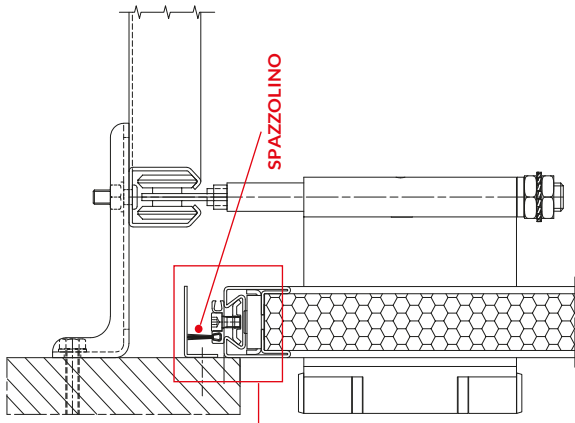

**SOLUZIONE STANDARD**  
parte superiore  
**CON SPAZZOLINO**

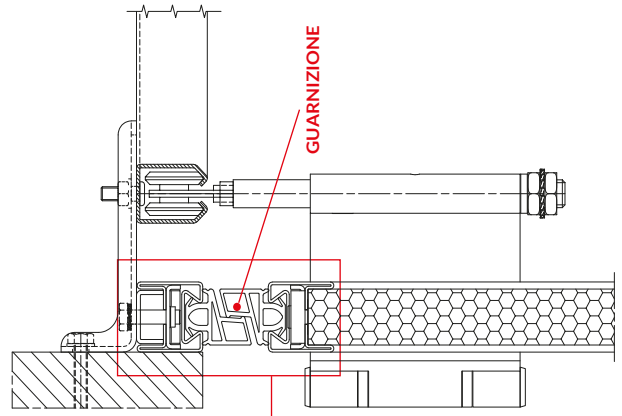

**SOLUZIONE ELEGANT**  
parte superiore  
**CON GUARNIZIONE e PROFILLO DI CORNICE**

\*In questa sezione, la posizione degli articoli illustrati rispetto al muro, potrebbe cambiare in base alla tipologia di posa.

LUCE DI PASSAGGIO

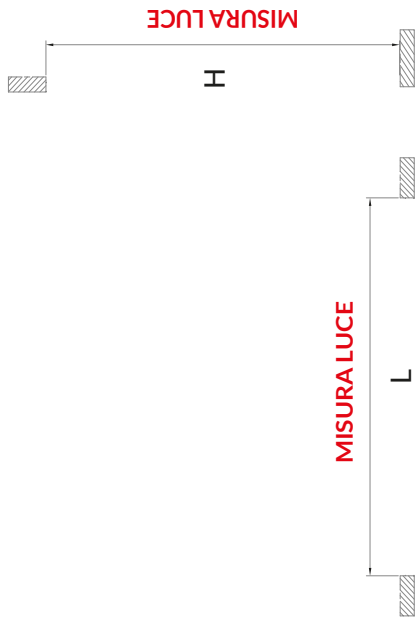

TIPOLOGIE DI POSA

**POSA PARZIALMENTE FUORI LUCE**

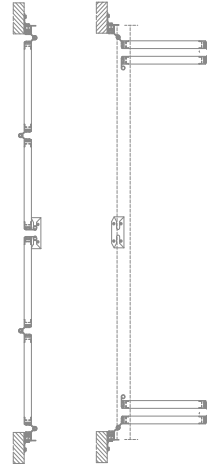

**POSA IN LUCE**

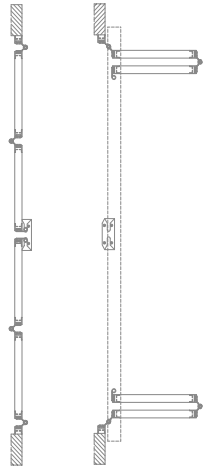

**POSA FUORI LUCE**

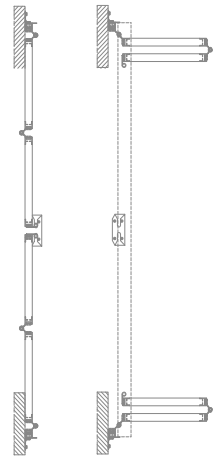

**ATTENZIONE:**

Le soluzioni "Parzialmente fuori luce" e "Fuori luce" necessitano di spazio laterale oltre luce. Se tale spazio risulta limitato potete contattare la NovaFerr per verificare la fattibilità di tale soluzione di posa.

## Portone con piantoni laterali senza guida a terra tipologia 2+2 ribaltamento 90°

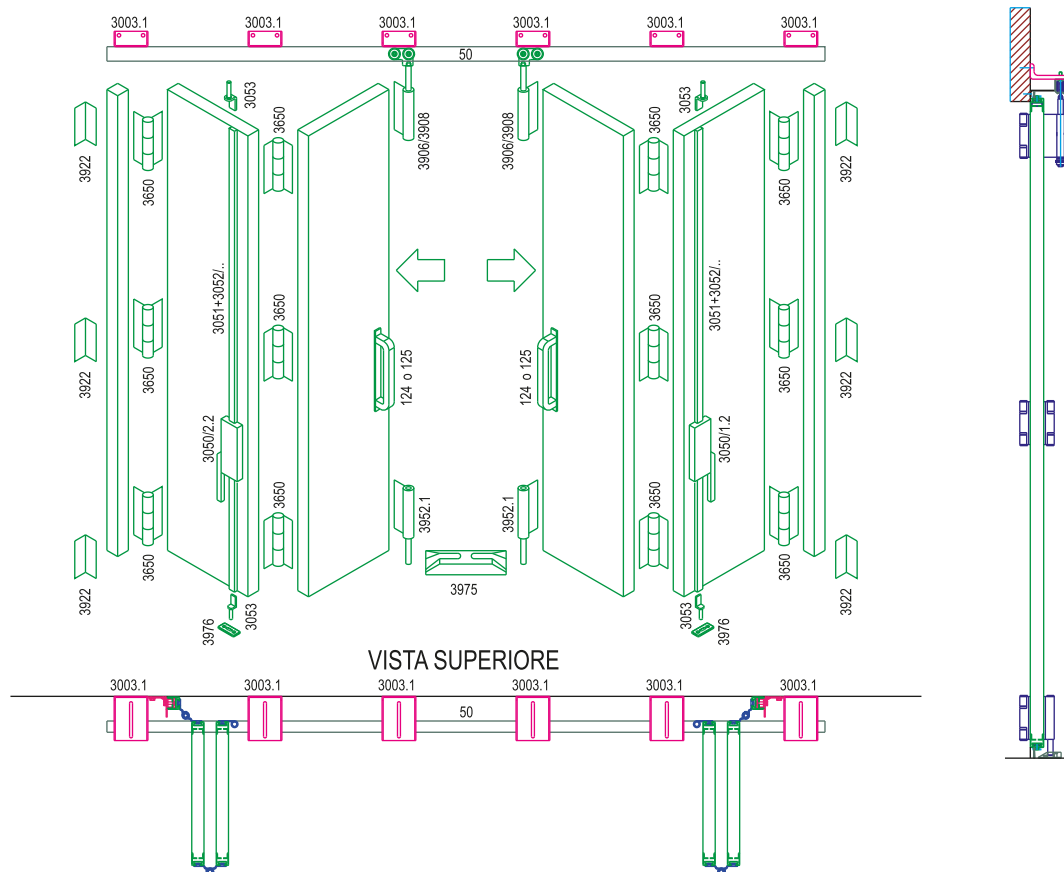

## Portone con piantoni laterali senza guida a terra tipologia 2+1 ribaltamento 180°

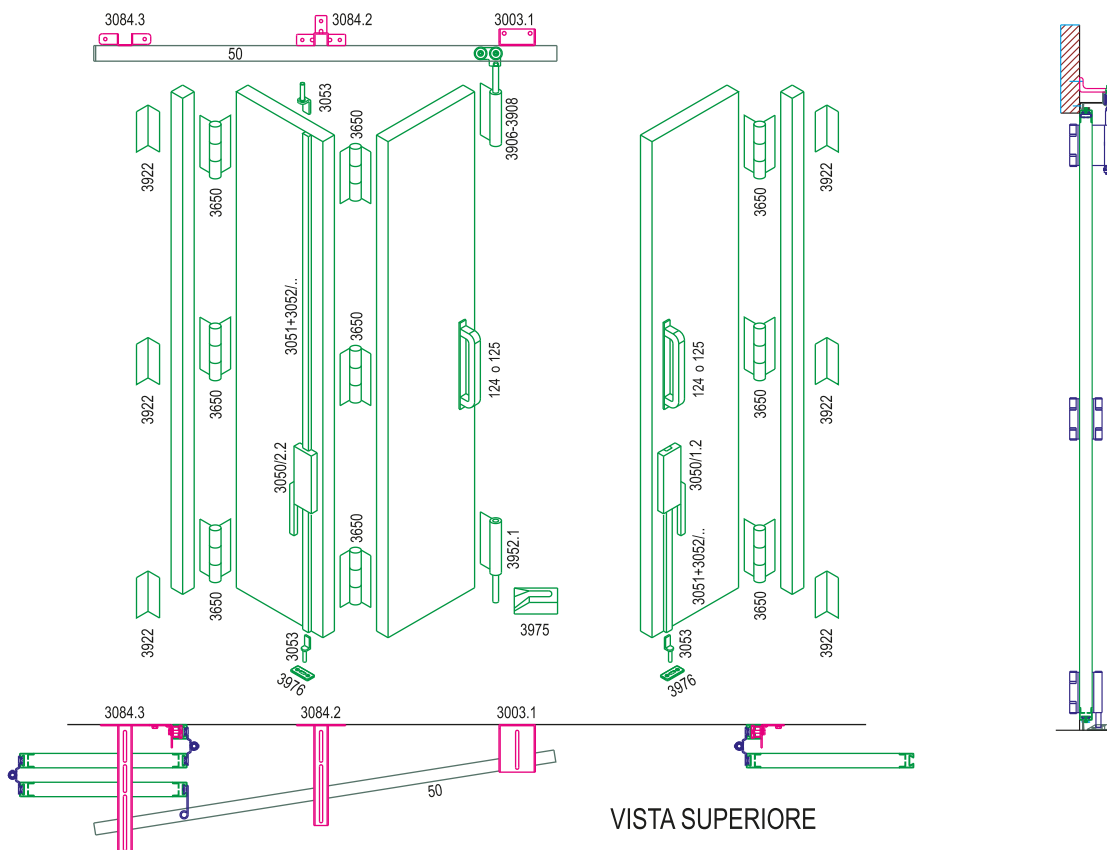

CONSULTARE SEMPRE IL MANUALE TECNICO. LE IMMAGINI SONO A PURO SCOPO ESEMPLIFICATIVO

Portone con pianti laterali senza guida a terra tipologia 3+1 ribaltamento 180°

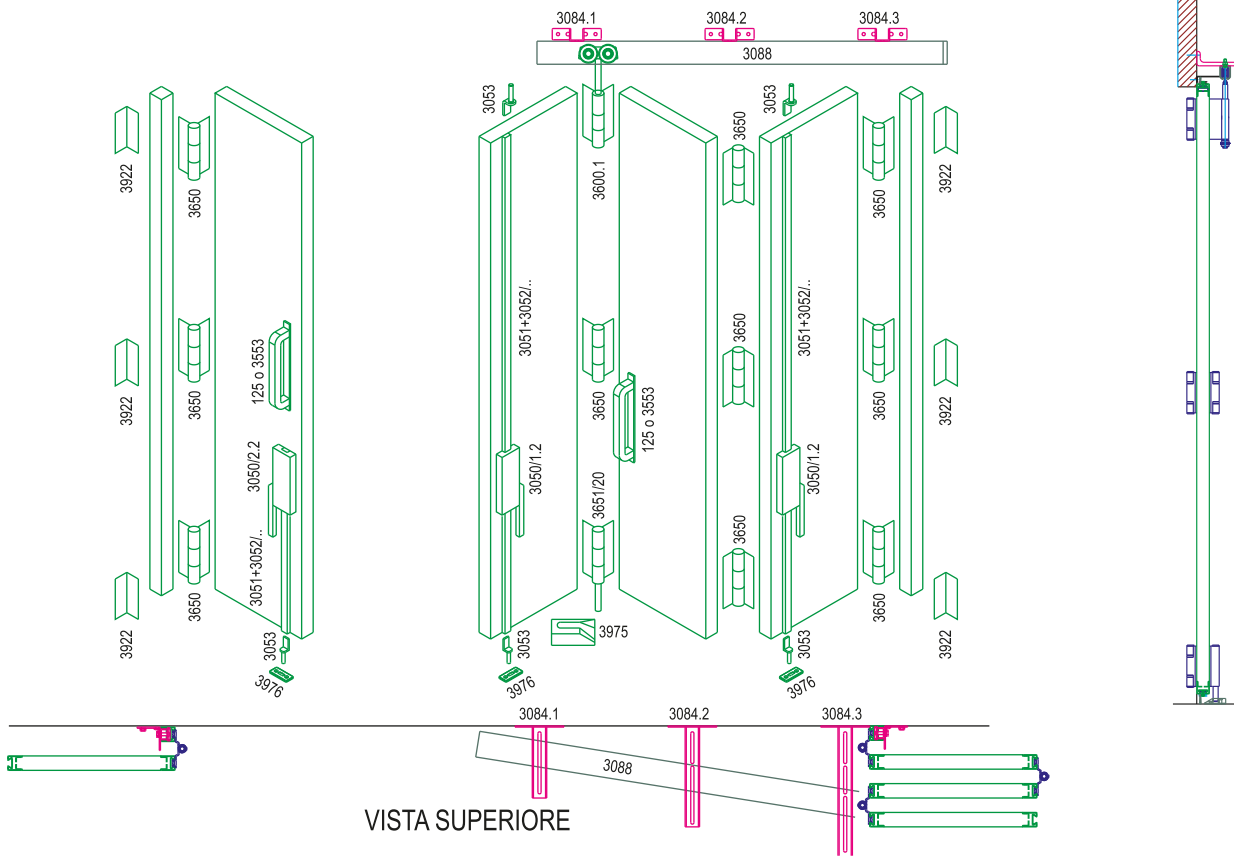

Portone con pianti laterali senza guida a terra tipologia 3+3 ribaltamento 180°

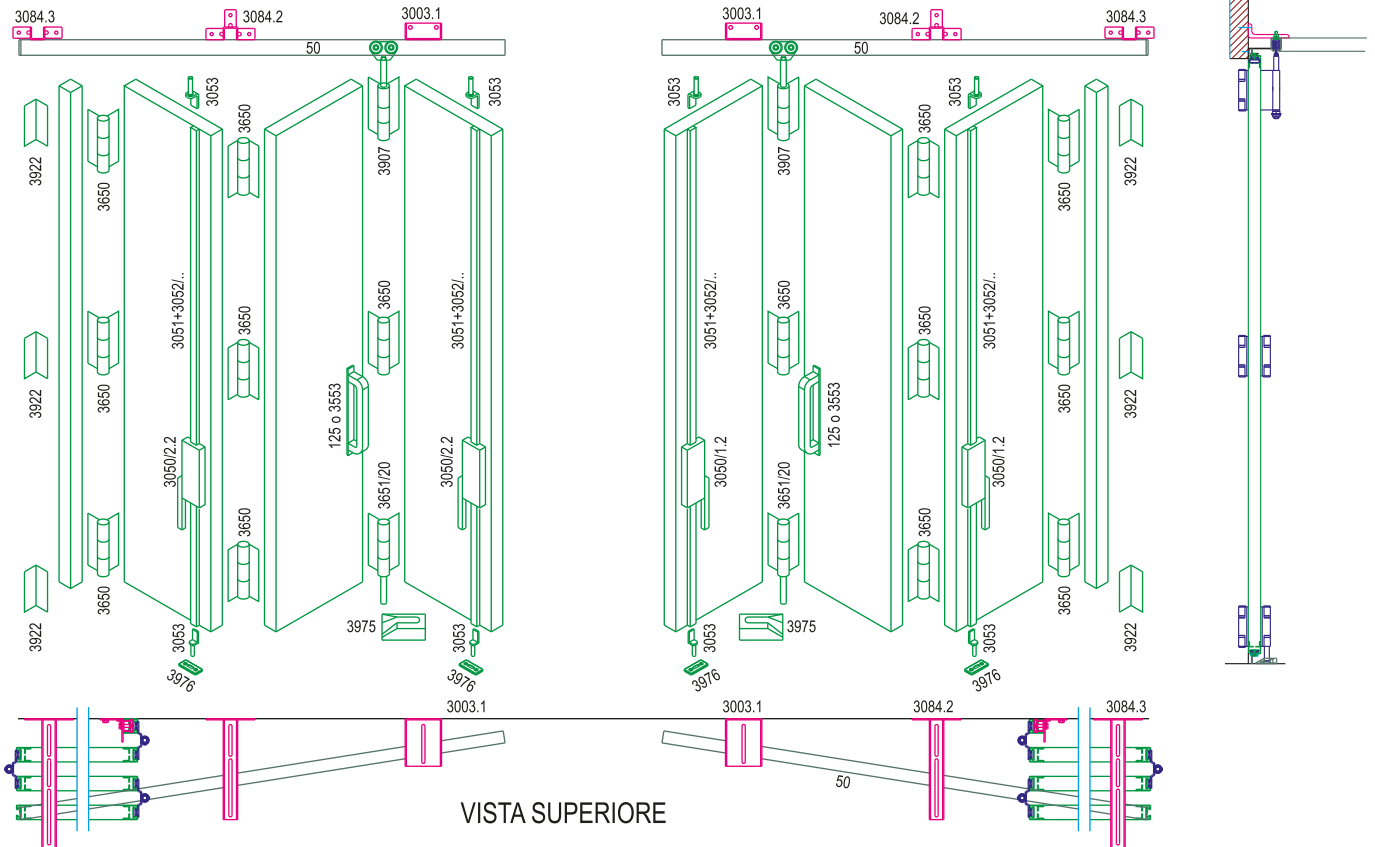

CONSULTARE SEMPRE IL MANUALE TECNICO. LE IMMAGINI SONO A PURO SCOPO ESEMPLIFICATIVO

**Portone senza piantoni laterali con guida a terra tipologia 4 ante con raccolta Sx**

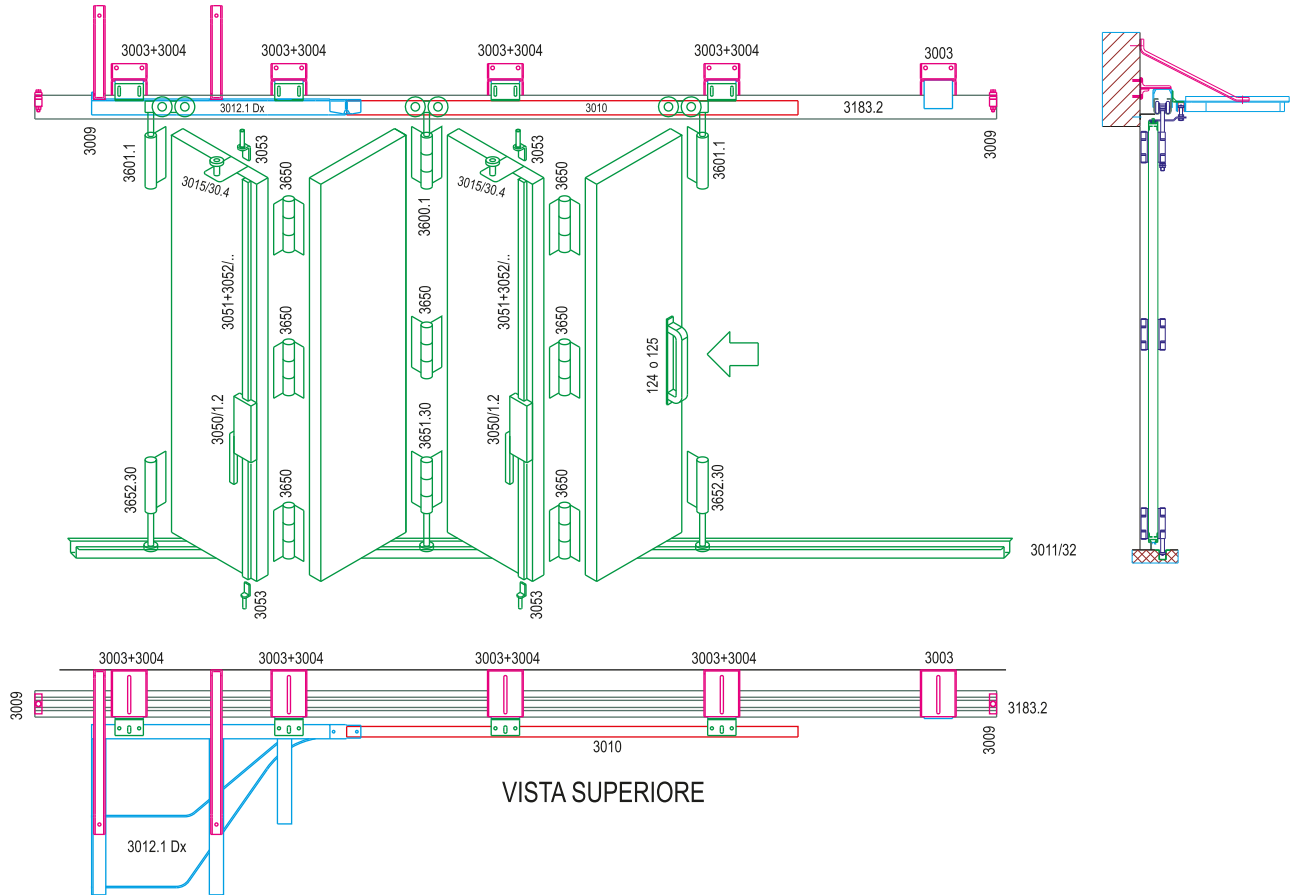

**Portone senza piantoni laterali con guida a terra tipologia 8 ante doppia raccolta**

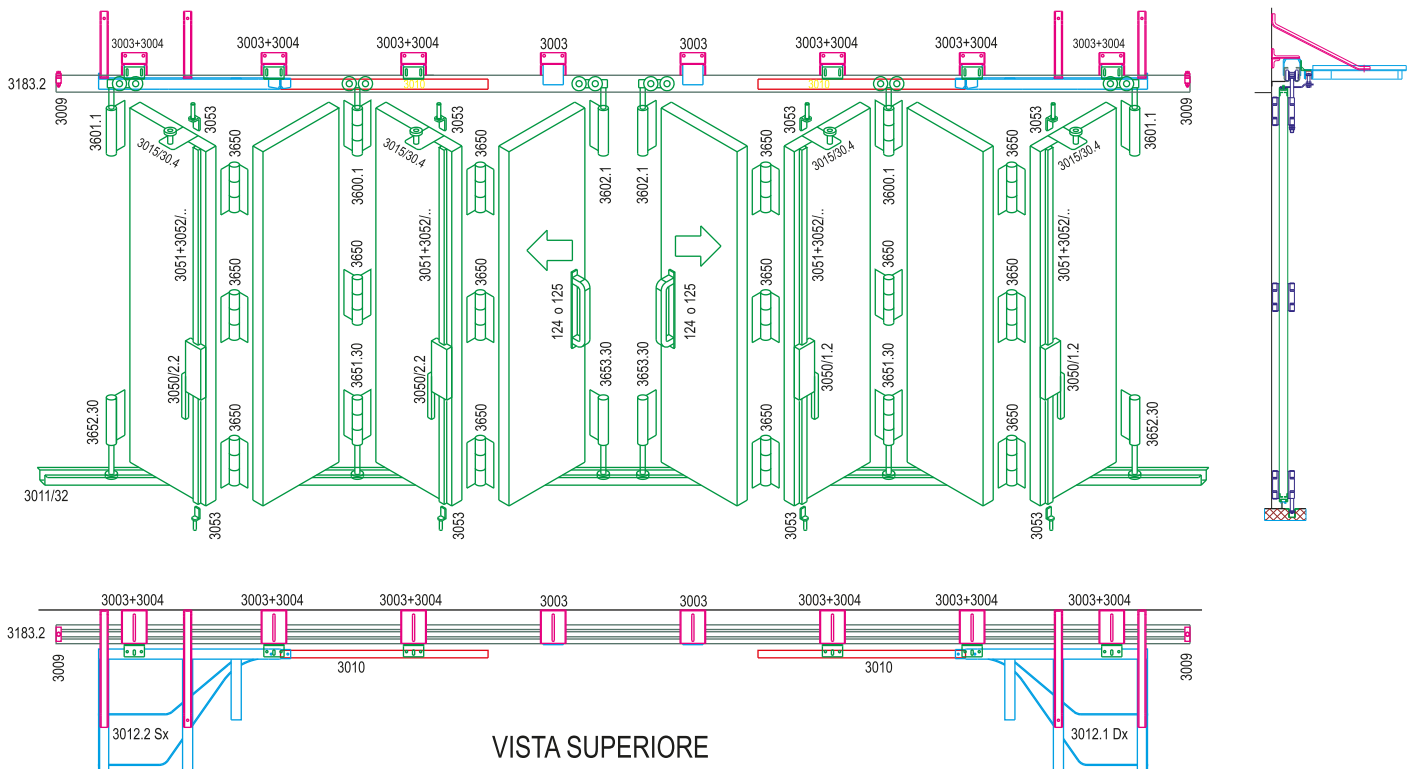

CONSULTARE SEMPRE IL MANUALE TECNICO. LE IMMAGINI SONO A PURO SCOPO ESEMPLIFICATIVO

Portone tipologia scorrevole appeso con carrelli

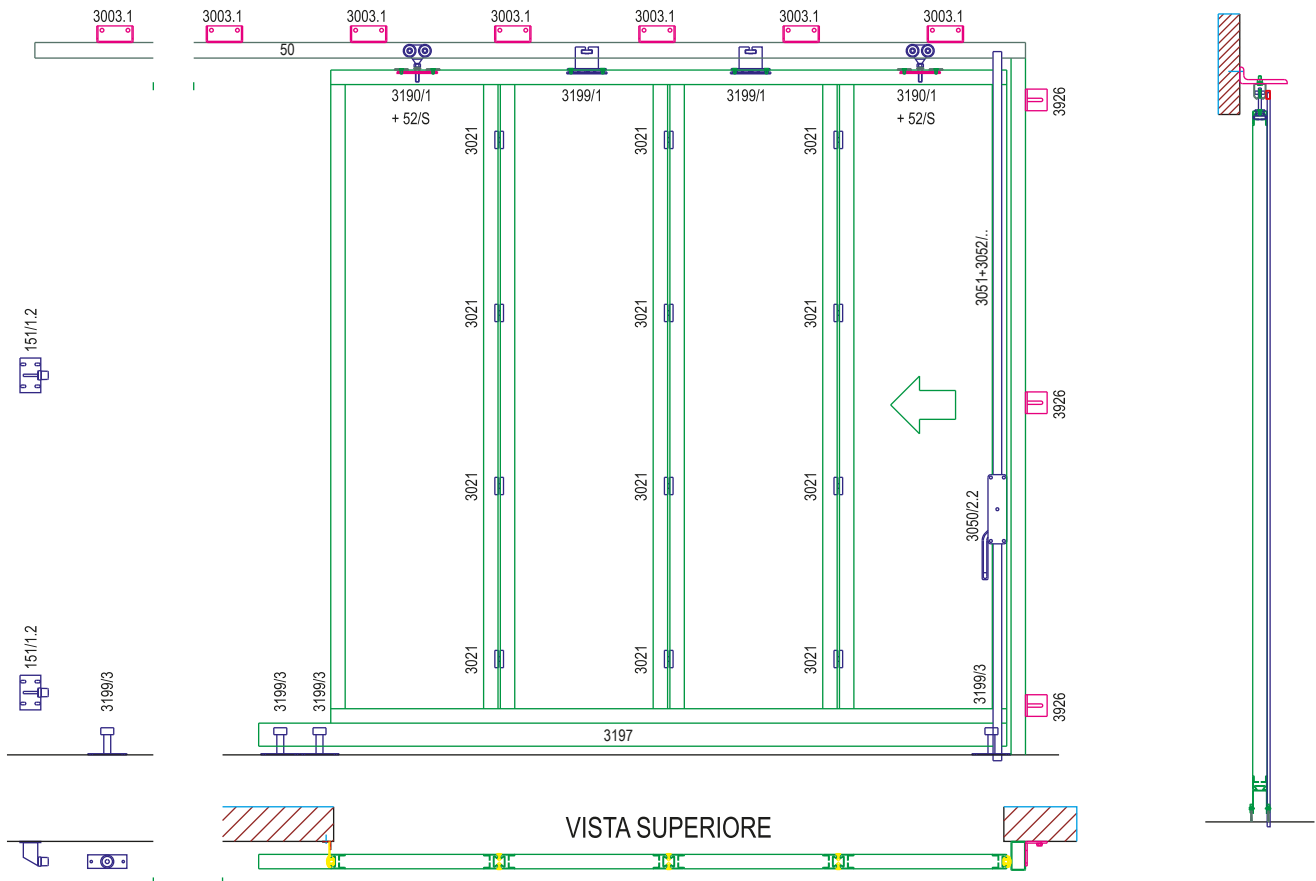

Portone tipologia scorrevole appoggiato su ruote

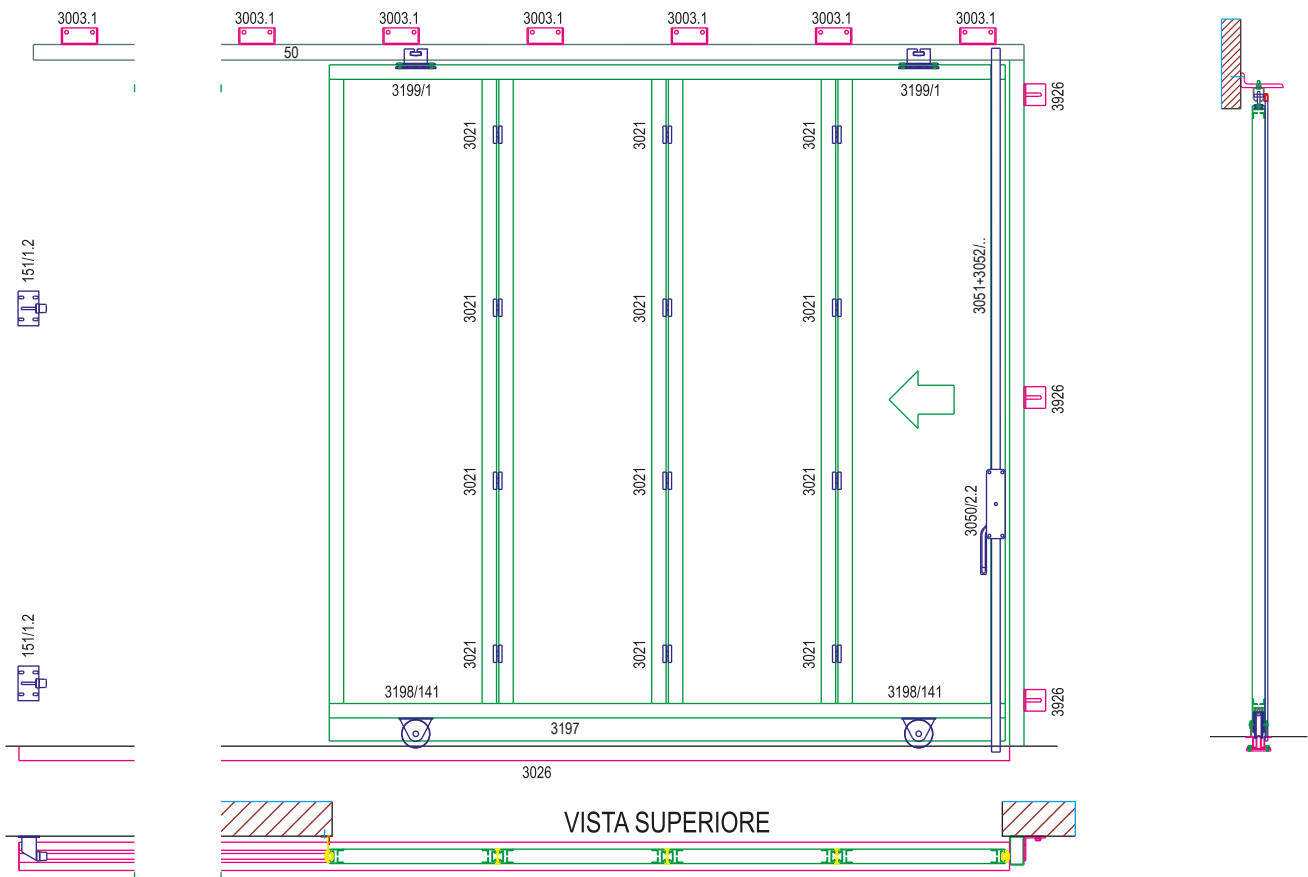

CONSULTARE SEMPRE IL MANUALE TECNICO. LE IMMAGINI SONO A PURO SCOPO ESEMPLIFICATIVO



# NOVA-FERR srl

ACCESSORI PER FINESTRE  
WINDOWS ACCESSORIES



**ARTIK**<sup>®</sup>  
CONTROTELAIO A TAGLIO TERMICO

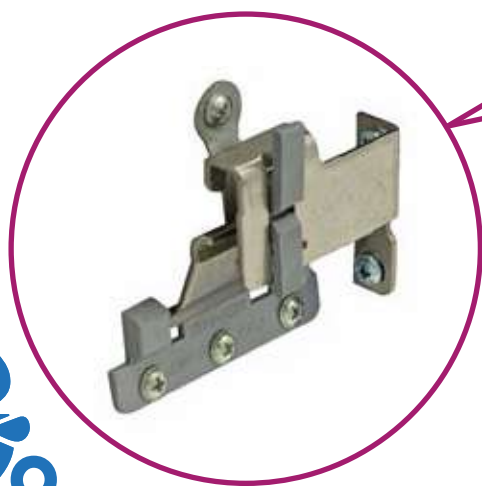

  
Blocca Avvolgibile Automatico

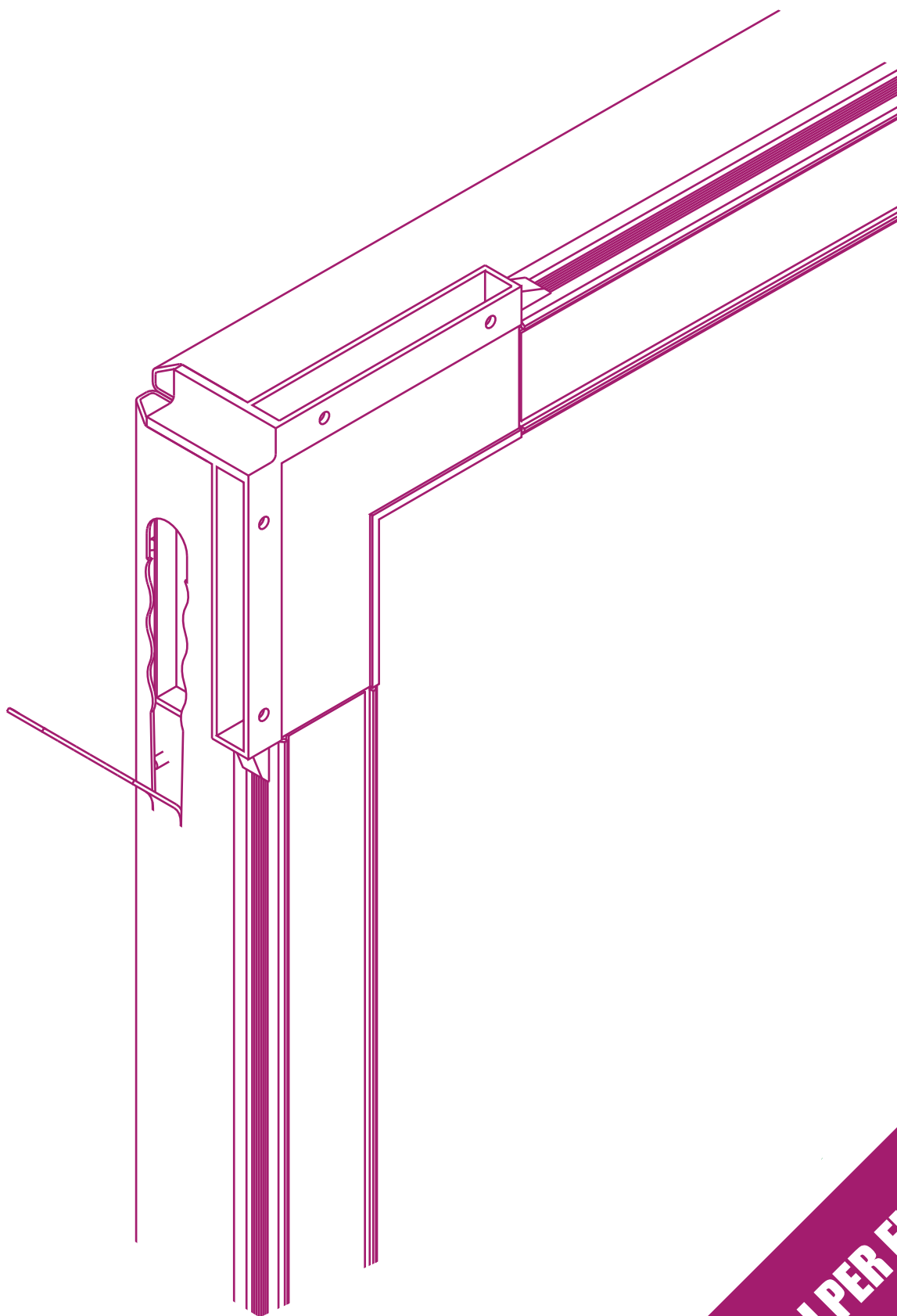

# ACCESSORI PER FINESTRE

Windows accessories - Accessoires pour fenêtres  
Accesorios para ventanas  
Zubehör für Fenster

**CATALOGO  
N.25**

# CONTROTELAIO A TAGLIO TERMICO ARTIK®

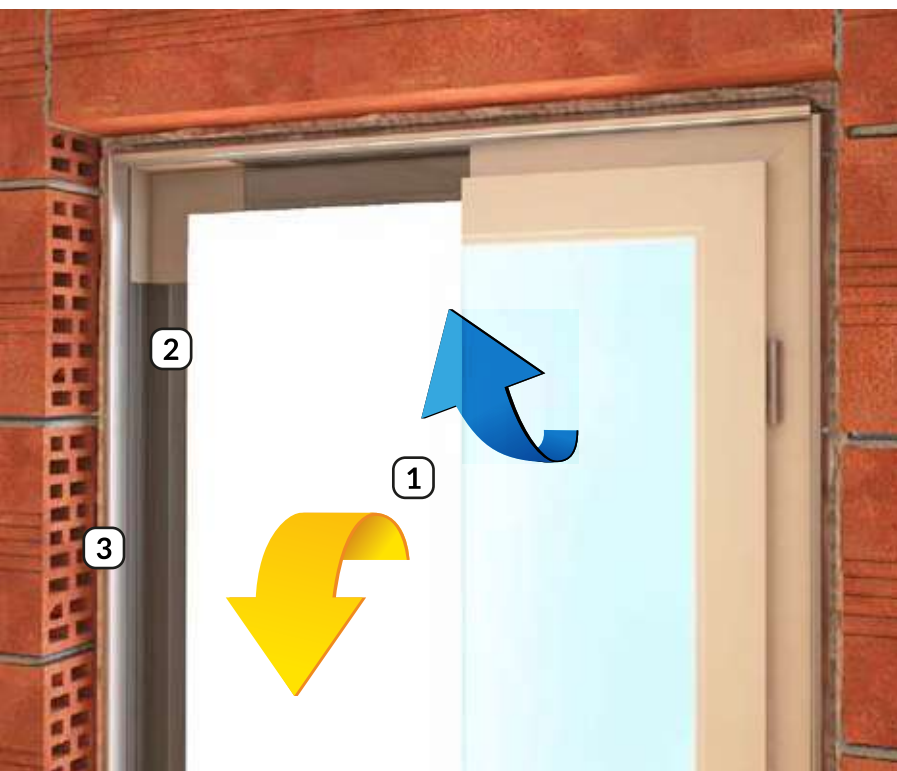

## ARTIK®

- ① **TERMICO** perchè il profilo esterno in PVC A BASSA TRASMITTANZA non lascia passare il freddo e il caldo all'interno.
- ② **ROBUSTO** perchè la struttura portante è in ACCIAIO.
- ③ **SANO** perchè tenendo il freddo all'esterno ELIMINA la creazione di MUFFE tra muro e serramento.

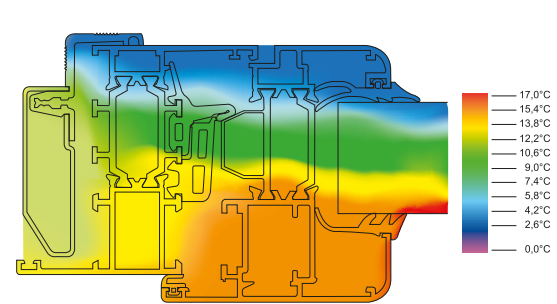
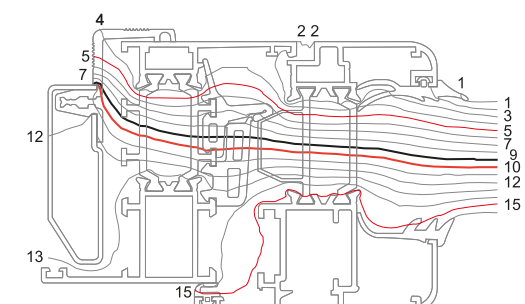

### MENO UMIDITÀ

Utilizzando un controte laio ARTIK

### PIÙ CALORE

Utilizzando un controte laio ARTIK

### CONDUTTIVITA' TERMICA PVC ("λ")

λ (W/mK): 0,12 - 0,17

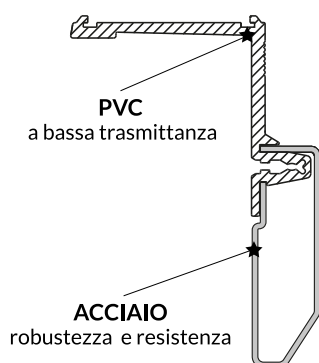

### TABELLA COMPARATIVA CARATTERISTICHE TECNICO / STRUTTURALI

CONTROTELAIO	ROBUSTEZZA	ISOLAMENTO TERMICO	RESISTENZA ALLA DILATAZIONE DA UMIDITÀ	INALTERABILITÀ MATERIALE
ARTIK	★★★★★	★★★★★	★★★★★	★★★★★
FERRO	★★★★★	★	★★★★★	★★★★★
LEGNO	★★	★★★★★	★	★★
PVC	★★	★★★★★	★★★★★	★★★★★

## LA TECNOLOGIA AL SERVIZIO DEL RISPARMIO ENERGETICO

- 4** **COMPLETO** perchè dotato di ACCESSORI adatti ad ogni tipo di posa.

---

- 5** **RAPIDO** nel montaggio, senza saldature, grazie alle COMPONENTI AD INCASTRO.

---

- 6** **UNIVERSALE** perchè compatibile con tutte le tipologie di serramento in commercio, ALLUMINIO, LEGNO, PVC.

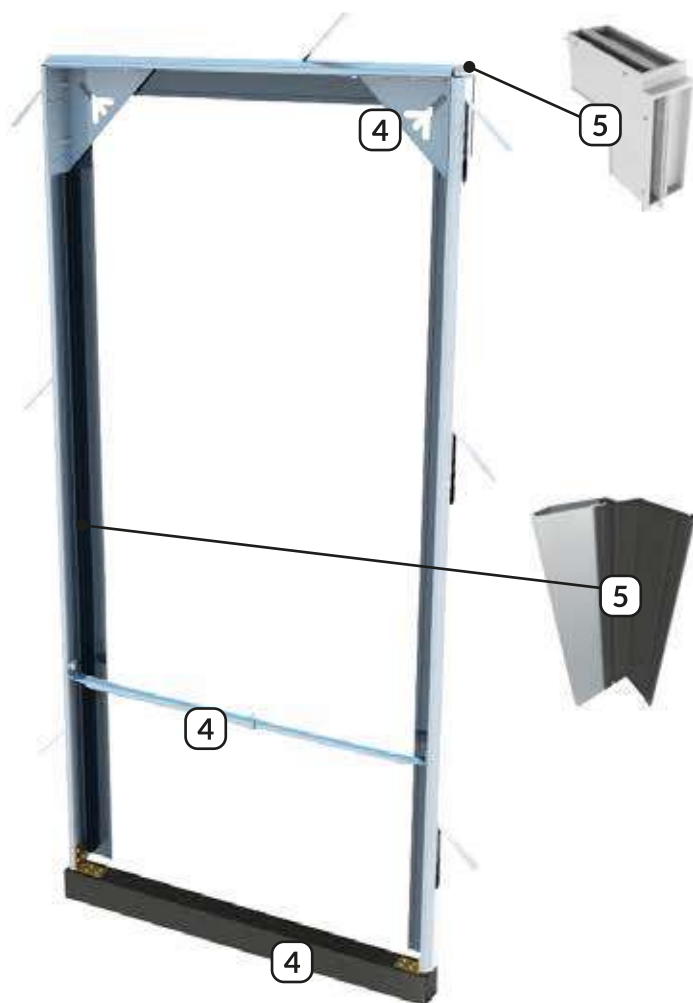

Fornito in comodo KIT con componenti già tagliati e pre-assemblati oppure in barre da tagliare, Il vantaggio di Artik risiede nella sua versatilità e semplicità di montaggio ed installazione. Un completo MANUALE DI POSA scaricabile dal sito [www.novaferr.com](http://www.novaferr.com) ed i VIDEO TUTORIAL ONLINE sul canale **YouTube Novaferr**, vi supporteranno durante la posa, descrivendo le varie tipologie di utilizzo.

Per maggiori informazioni tecniche o commerciali scrivi a: [info@novaferr.com](mailto:info@novaferr.com)

Sul nostro sito [www.novaferr.com](http://www.novaferr.com) potrete scaricare il Catalogo Listino ed il Manuale di Posa di ARTIK



Guarda i video di ARTIK sul canale youtube di NovaFerr.



[www.youtube.com/user/novaferr](http://www.youtube.com/user/novaferr)

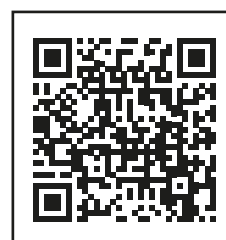

## BLOCCA TAPPARELLA AUTOMATICO GENIOBLOCK

Un sistema automatico e sempre inserito per la sicurezza della tua abitazione. Il meccanismo scatta solo se la tapparella viene sollevata dall'esterno e lascia traccia del tentativo di effrazione. Si installa in pochi minuti e non occorre manutenzione.



Guarda il video di GENIOBLOCK sul canale youtube di NovaFerr.





YouTube

[www.youtube.com/user/novaferr](http://www.youtube.com/user/novaferr)



**Blocca tapparella automatico inox GENIOBLOCK**

Art. 700

-  *Stainless steel automatic rolling shutter closer*
-  *Fermavolet roulant automatique en acier inox*
-  *Dispositivo en acero inox para cerrar las persianas*
-  *Sicherheitsschloss für Rollläden aus Edelstahl*

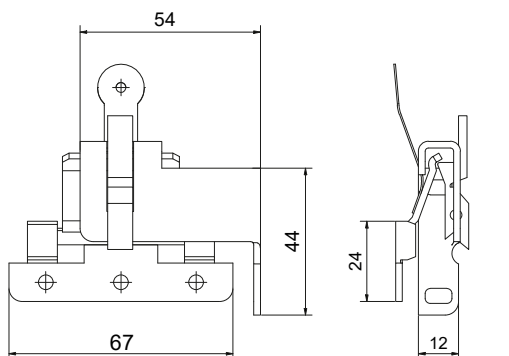
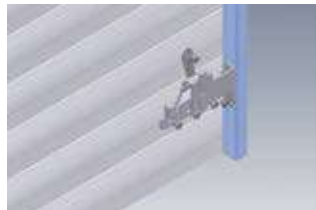

Materiale: Acciaio inox

Art.	Peso(g)	Conf.
700	150	20cop.

**Caratteristiche GENIOBLOCK**

GENIOBLOCK viene consegnato in confezione BLISTER all'interno di un BOX di cartone studiato apposta per essere collocato su scaffalature a rastrelliera o su banconi per un agevole prelievo per il cliente finale.



Se il dispositivo GENIOBLOCK interviene, rimane bloccato segnalando il tentativo di scasso.

Per sbloccare il dispositivo agire sulla leva tirandola verso di sé



All'interno del BLISTER ci sono 2 dispositivi GENIOBLOCK uno da posizionare sul lato sx della tapparella, uno sul lato dx della tapparella.

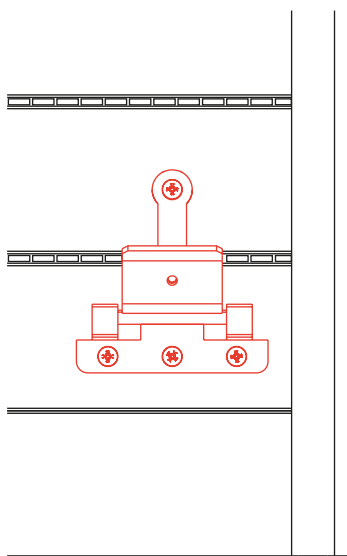

**Installazione su tapparella**  
Tramite dima di foratura predisporre i fori sulla doga della tapparella tramite le viti in dotazione fissare il dispositivo

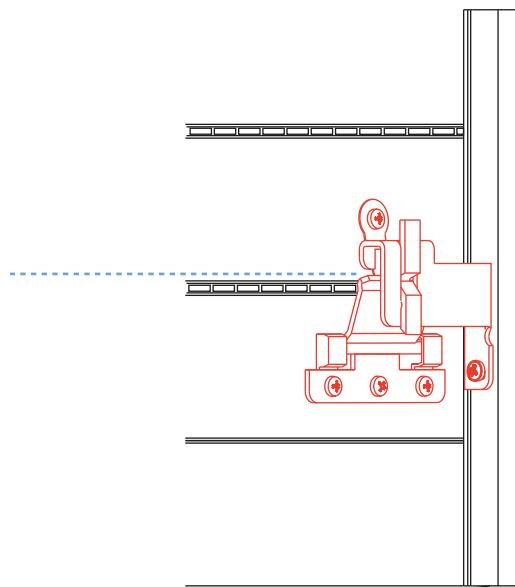

**Installazione su montante**  
Presentare il dispositivo sul montante laterale, fare i fori ed ancorare lo stesso al montante

# NOVA-FERR srl

ACCESSORI PER FACCIATE CONTINUE  
CURTAIN WALLS ACCESSORIES



# FACCIATE



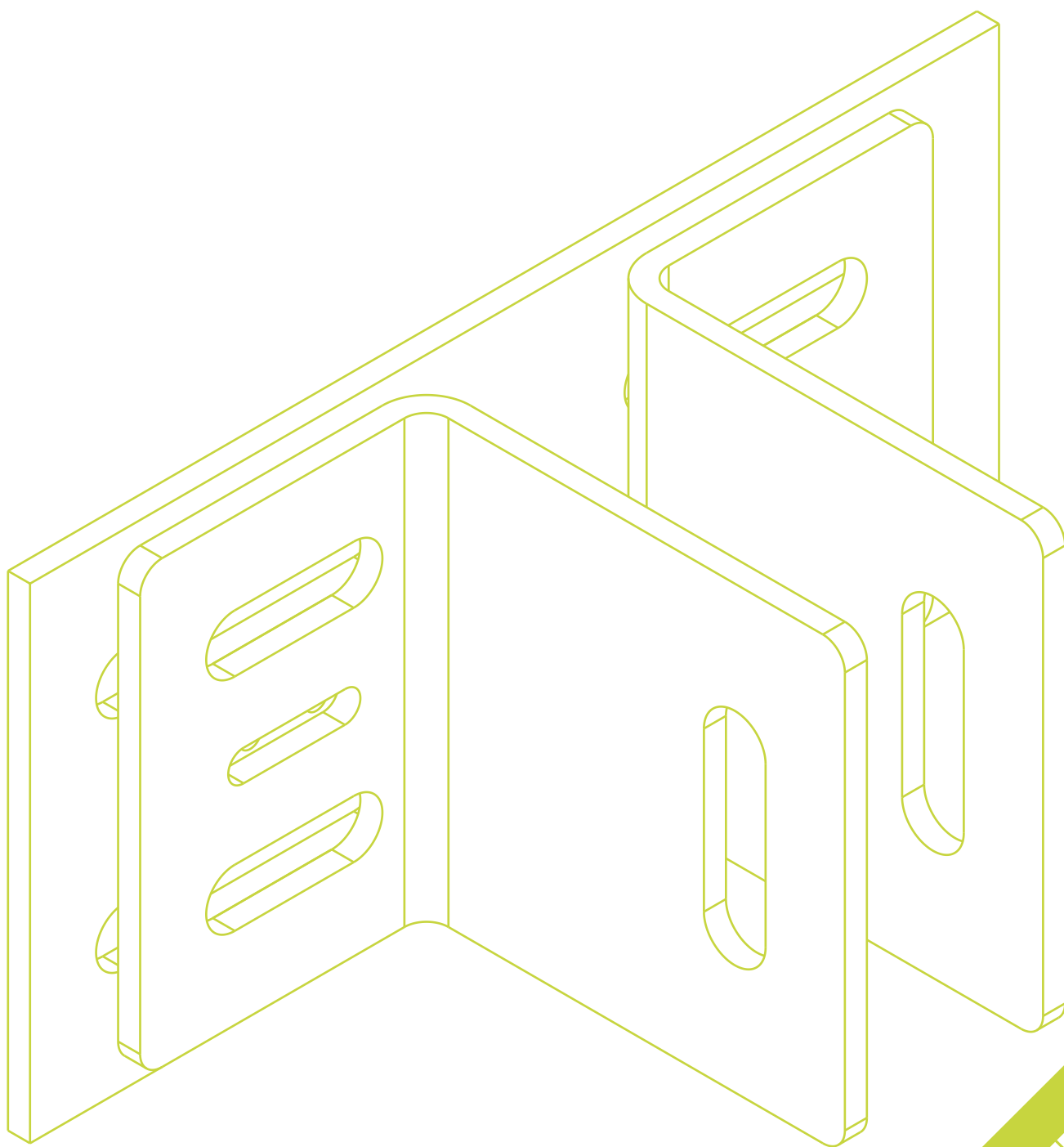

# ACCESSORI PER FACCIATE CONTINUE

Curtain wall accessories - Accessoires pour murs-rideaux  
Accesorios para muros cortina  
Zubehör für Vorhangfassaden

**CATALOGO  
N.25**



## Art. 6500.1

## Staffa simmetrica con asole orizzontali

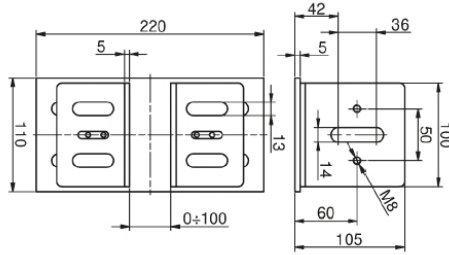

Symmetrical clamp with horizontal slots

Bride symétrique avec fentes horizontales

Soporte simétrico con oiales horizontales

Symmetrische Fenstereinsatzelement mit horizontalen Langlöchern

Materiale: Acciaio verniciato

Art.	Peso(g)	Conf.
6500.1	1.940	10



## Art. 6500.2

## Staffa simmetrica con asole verticali

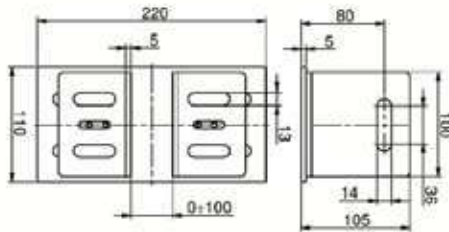

Symmetrical clamp with vertical slots

Bride symétrique avec fentes verticales

Soporte simétrico con oiales verticales

Symmetrische Fenstereinsatzelement mit vertikalen Langlöchern

Materiale: Acciaio verniciato

Art.	Peso(g)	Conf.
6500.2	1.940	10



## Art. 6500.3

## Staffa asimmetrica con asole orizzontali

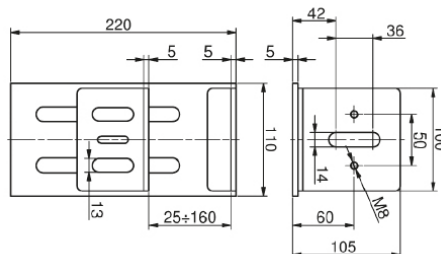

Asymmetrical clamp with horizontal slots

Bride asymétrique avec fentes horizontales

Soporte asimétrico con oiales horizontales

Asymmetrische Fenstereinsatzelement mit horizontalen Langlöchern

Materiale: Acciaio verniciato

Art.	Peso(g)	Conf.
6500.3	2.340	5



**Staffa asimmetrica con asole verticali**

Art. 6500.4

 *Asymmetrical clamp with vertical slots*

 *Bride asymétrique avec fentes verticales*

 *Soporte asimétrico con ojales verticales*

 *Asymmetrische Fenstereinsatzelement mit vertikalen Langlöchern*

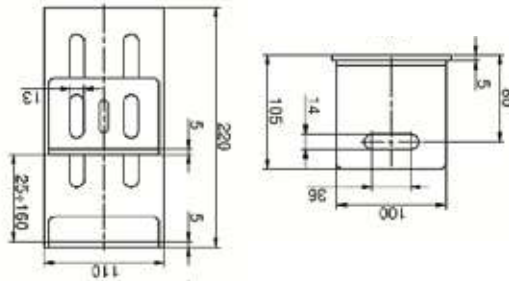

Materiale: Acciaio Verniciato

Art.	Peso(g)	Conf.
6500.4	2.340	5



**Viti di fissaggio per staffe**

Art. 6500.5

 *Fastening screws for clamps*

 *Vis de fixation pour brides*

 *Tornillos de fijación para soporte*

 *Befestigungsschrauben für Fenstereinsatzelement*

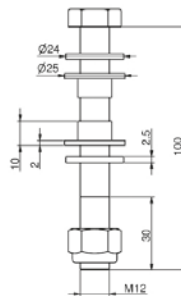

Materiale: Acciaio Zincato

Art.	Peso(g)	Conf.
6500.5	130	50

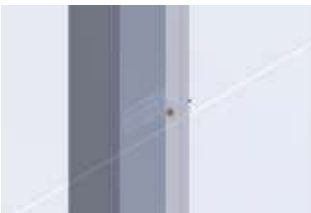

## SCHEMA STAFFE PER FACCIATE CONTINUE

 Layout of brackets for curtain walls

 Esquema soportes para fachadas continuas

 Schema des brides pour facades continues

 Positionierung der Befestigungsplatten in Glas-Vorhangfassaden

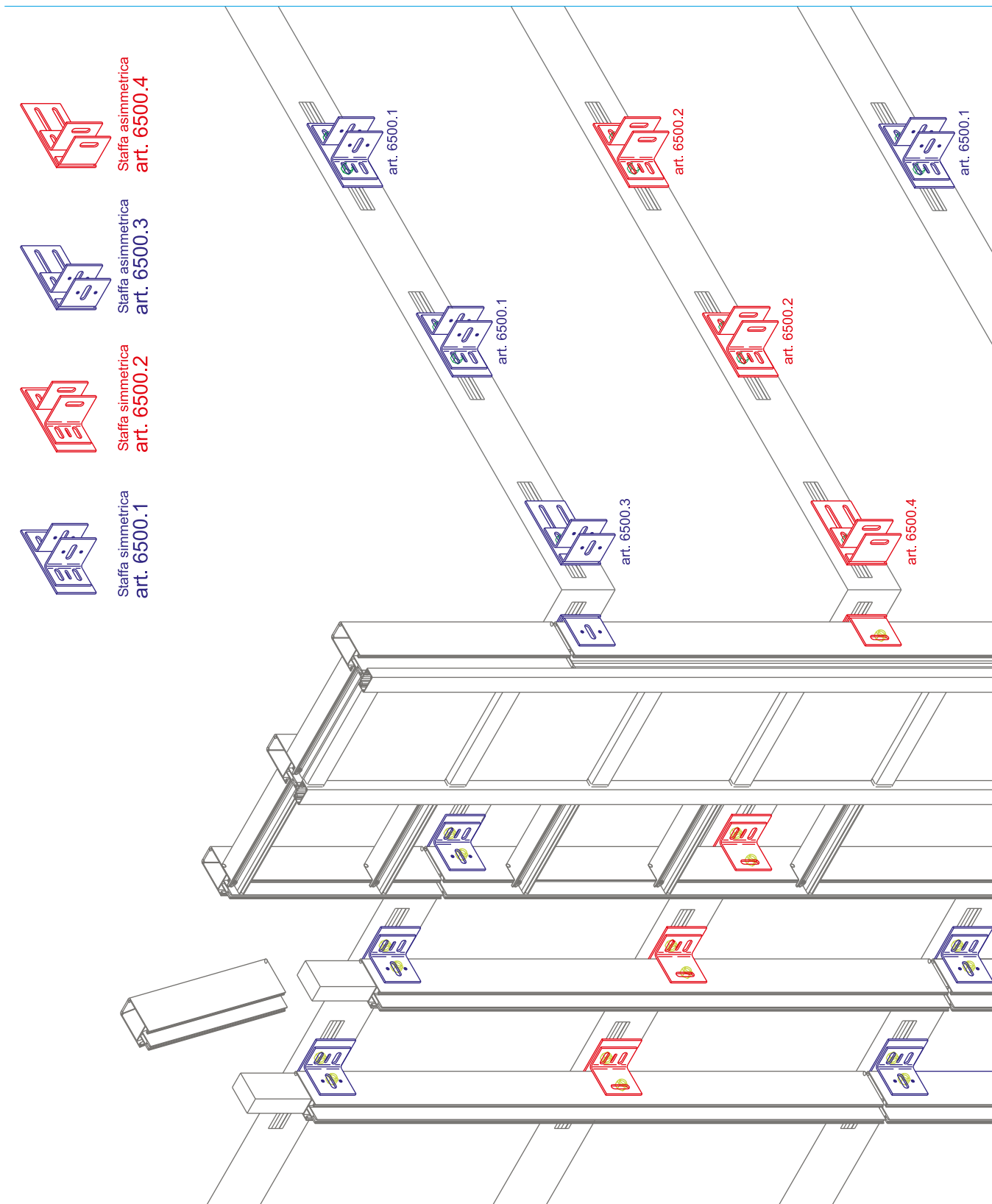

Ancoraggio delle staffe per le facciate continue

Principi generali di supporto e ancoraggio:

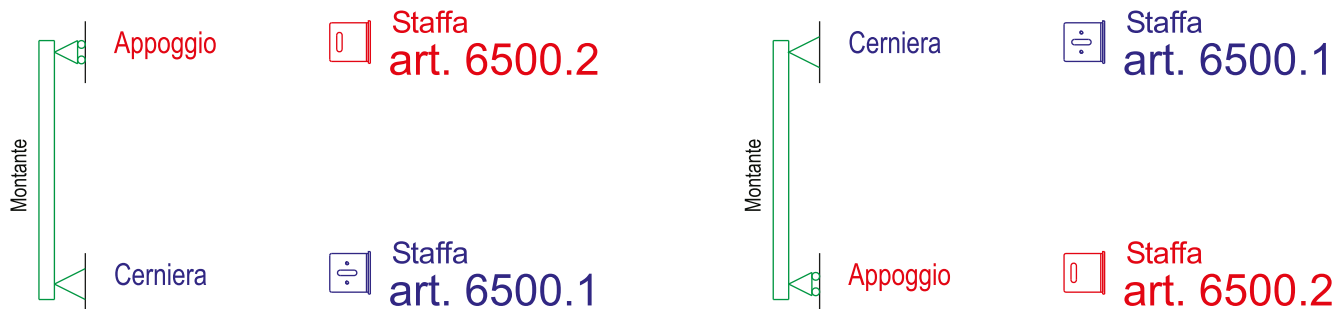

Principio A:  
Montante bloccato all'estremità inferiore

Principio B:  
Montante bloccato all'estremità superiore

Principio di GERBER (travi continue su n° \_ appoggi):

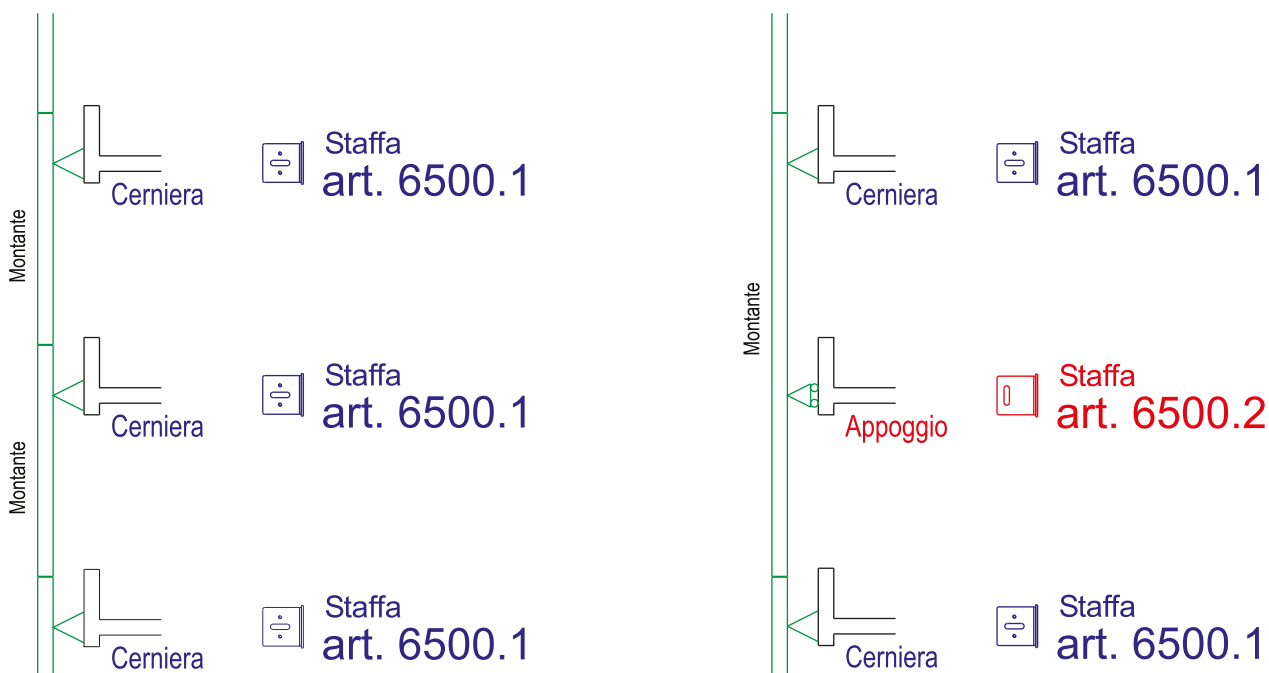

Principio C:  
montante altezza di 1 piano

Principio D:  
montante altezza di 2 piani

(\*) Altezza parapetto muratura

(\*\*) Collegamento del montante, ottimale a H/5, giusto sotto la traversa del parapetto, (se esistente) tenendo in considerazione le condizioni per il successivo tamponamento.

Nella realtà, ci si trova con la soletta pulita dove posizionare le staffe, quindi il collegamento tra i 2 montanti avviene in questo punto, anche per tenerlo il più possibile nascosto dall'interno.

# NOVA-FERR srl

ACCESSORI VEICOLI INDUSTRIALI  
INDUSTRIAL VEHICLE ACCESSORIES



Catenacci  
Art. 410



## Cerniere

Art. 400



Art. 401



Art. 402



Art. 420



Art. 421



## Supporti

Art. 403



Art. 408



Art. 413 - 414



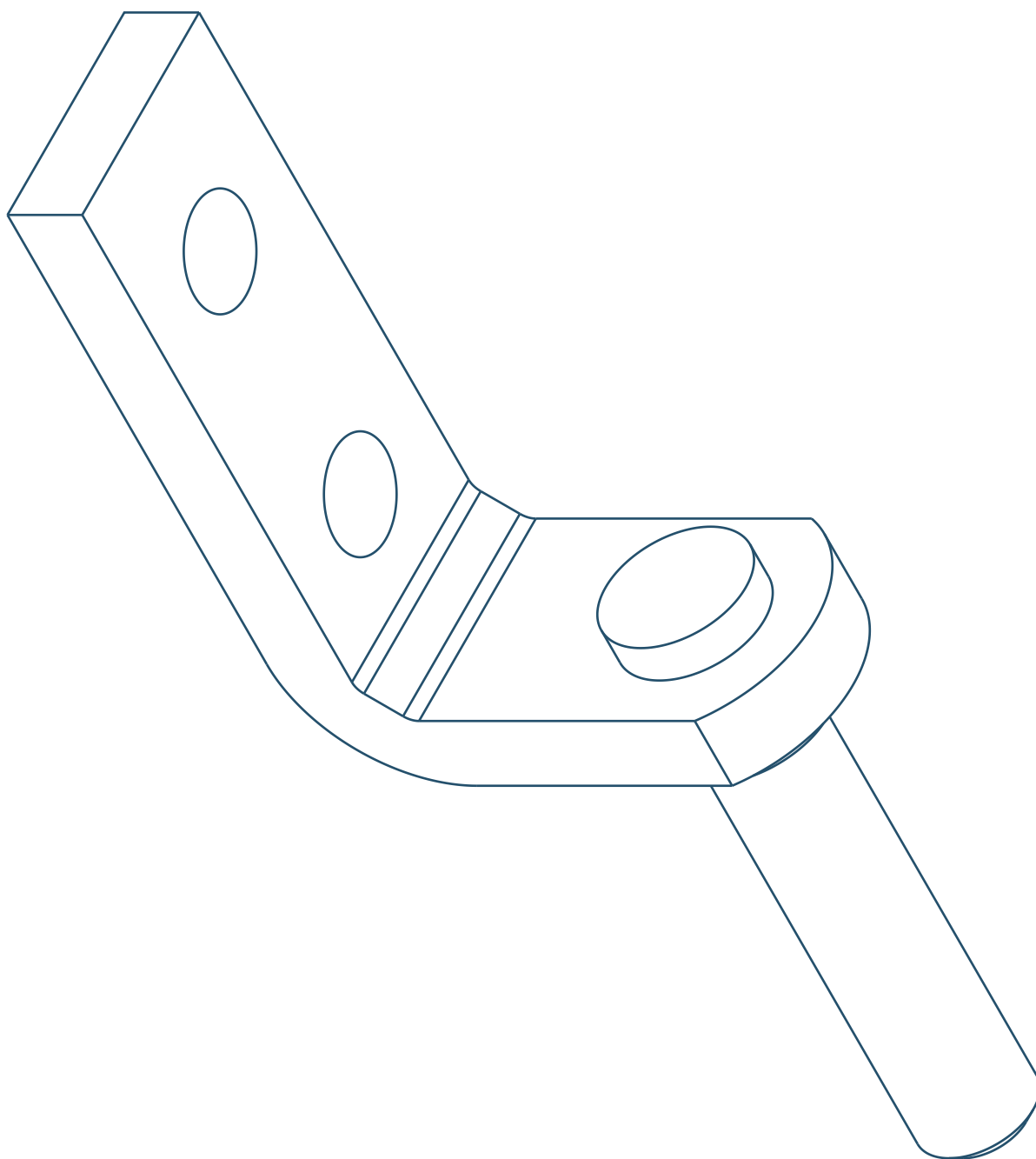

# ACCESSORI PER VEICOLI INDUSTRIALI

Industrial vehicle accessories  
Accessoires pour véhicules industriels  
Accesorios para vehículos comerciales  
Zubehör für Nutzfahrzeuge

**CATALOGO  
N.25**

## Art. 400

## Cerniera maschio

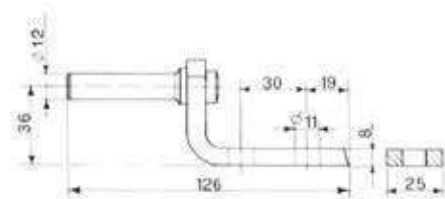

Materiale: Acciaio Zincato

Hinge

Charnière

Charnela

Kloben auf Platte zum Anschrauben, aus Edelstahl.

Art.	Peso(g)	Imb.
400	202	100

## Art. 401

## Cerniera tipo "R", parte mobile

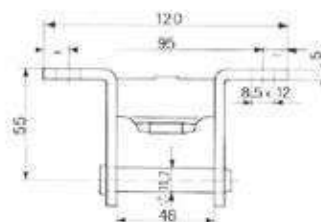

Materiale: Acciaio zincato

Hinge "R" type, movable part

Charnière type "R", partie mobile

Charnela model "R", parte móvil

Montagebügel Stellbordscharnier R-Profil. Beweglicher Teil

Art.	Peso(g)	Imb.
401	252	100

## Art. 402

## Cerniera tipo "R", parte fissa

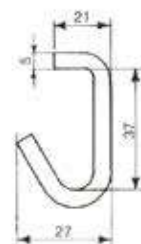

Materiale: Acciaio zincato

Hinge "R" type, fixed part

Charnière type "R", partie fixe

Charnela model "R", parte fija

R-Profil. Gegenhaken. Zum Anschweißen

Art.	Peso(g)	Conf.
402	172	100

## Art. 420

## Cerniera parte mobile

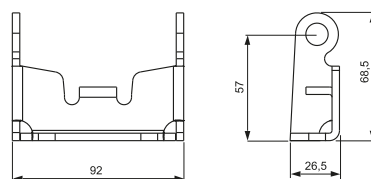

Materiale: Acciaio Zincato

Hinge "R" type, movable part

Charnière type "R", partie mobile

Charnela model "R", parte móvil

Montagebügel Stellbordscharnier R-Profil. Beweglicher Teil

Art.	Peso(g)	Conf.
420	35	35

## Art. 421

## Cerniera parte fissa

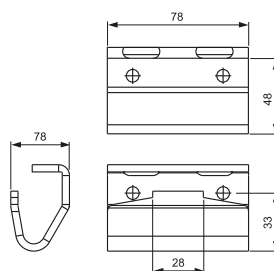

Materiale: Acciaio Zincato

Hinge "R" type, fixed part

Charnière type "R", partie fixe





Charnela model "R", parte fija

Gegenhaken, fester Teil. Zum Anschrauben

Art.	Peso(g)	Conf.
421	35	35

**Bussola in alluminio o zincato**

Art. 404

-  Luminium or iron bush
-  Boussole en aluminium ou en fer
-  Brújula en acero o en aluminio
-  Buches aus Aluminium oder Eisen

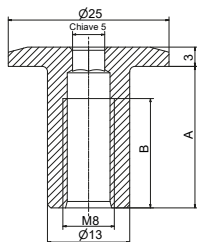





Materiale: Alluminio / Ferro

Art.	Var.	A	B	Peso(g)	Conf.	Imb.
404/25	Alluminio	22	17	8	500	1.000
404/30	Alluminio	27	21	8,5	500	1.000
404/25.1	Zincato	22	17	20	500	500
404/30.1	Zincato	27	21	20	500	500

**Piastrina a 3 fori**

Art. 407

-  Plate with 3 holes
-  Platine avec 3 trous
-  Placa con 3 agujeros
-  3-Löcher Befestigungsplatte

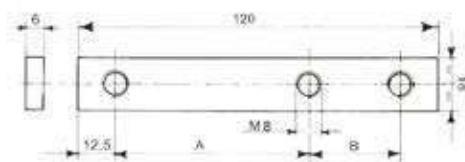





Materiale: Acciaio Zincato

Art.	A	B	Peso(g)	Conf.
407	65	30	88	100
407/1	70	25	88	100

**Piastrina a 2 fori**

Art. 406

-  Plate with 2 holes
-  Platine avec 2 trous
-  Placa con 2 agujeros
-  2-Löcher Befestigungsplatte

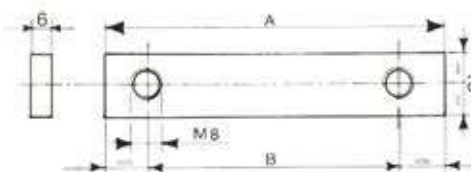





Materiale: Acciaio zincato

Art.	A	B	Peso(g)	Conf.	Imb.
406/1	55	30	38	100	500
406/2	95	70	70	100	100
406/3	95	75	70	100	100
406/4	55	25	37	100	500
406/5	120	50	102	100	100
406/6	120	55	98	100	100

**Piastrina a 1 foro**

Art. 412

-  Plate with 1 hole
-  Platine avec 1 trou
-  Placa con 1 agujero
-  1-Loch Befestigungsplatte

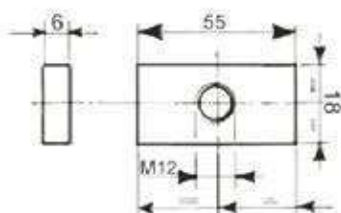

Materiale: Acciaio zincato

Art.	Peso(g)	Imb.
412	42	700



## Art. 405

## Perno per cerniera

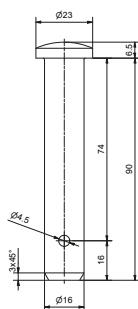

Pin for hinge

Pivot pour charnière

Pernio para charnela

Scharnierklöben aus rohem Stahl

Materiale: Acciaio grezzo

Art.	Peso(g)	Conf.
405	150	100

## Art. 409

## Perno per piantoni



Pin for steering columns

Pivot pour colonnes

Pernio para columnas

Klöben für Pfosten aus rohem Stahl

Materiale: Acciaio grezzo

Art.	Var.	Peso(g)	Imb.
409	17 x 70	138	100
409/3	17 x 105	200	75

## Art. 408

## Centina



Centre

Cintre

Cimbra

Rungentasche aus rohem Eisen

Materiale: Ferro

Art.	A	B	Peso(g)	Imb.
408/25	103	25	136	200
408/30	100	30	136	200

## Art. 410

## Catenaccio a molla

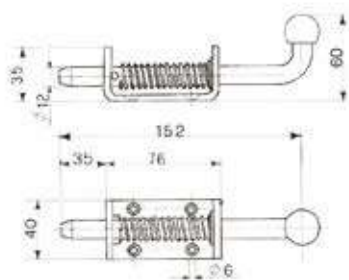

Spring bolt

Verrou à ressort

Pestillo con resorte

Federbolzen aus verzinktem Stahl

Materiale: Acciaio Zincato

Art.	Peso(g)	Conf.
410	350	24

**Supporto ruota** Art. 416



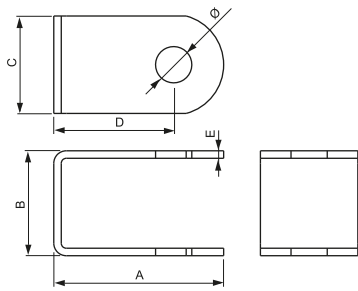

-  Wheel support
-  Support galet
-  Soporte para ruedas
-  Laufrolleträger



Materiale: Acciaio grezzo

Art.	A	B	C	D	Ø	E	Peso(g)	Conf.
416/1	52,5	27	39	32,5	10,5	3	100	20
416/2	56	42	39	36	14,5	3	110	20
416/3	68	42	39	48	14,5	3	140	20

**Ruota in acciaio zincato o inox con bullone, gola O** Art. 111 - 1 cuscinetto

-  Galvanized or stainless steel wheel with bolt, O groove
-  Galet en acier zingué ou inox avec boulon, gorge O
-  Rueda en acero cincado o inox con pernio, canal O
-  Laufrolle aus verzinktem Stahl oder Edelstahl mit Bolzen, O-Rille

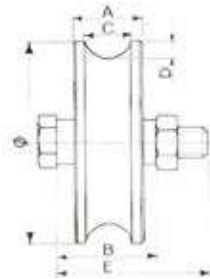

Materiale: Acciaio Zincato / Cataforesi

**N.B.** Per ordinare la versione Cataforesi aggiungere la lettera "C" alla fine del codice Es: 110/5/17C







1 Cuscinetto  
Mod. 2RS

1 Ball bearing  
1 Roulement  
1 Rodamiento

Art.	Ø	A	B	C	D	E	Peso(g)	Conf.
111/5/17	50	17	19	9,5	6,5	10X45	210	25
111/6/17	60	17	19	9,5	6,5	10X45	280	20
111/7/17	70	17	19	9,5	6,5	10X45	390	14
111/8/17	80	17	19	9,5	6,5	10X45	520	14

**Gancio tendifune stampato a freddo** Art. 403

-  Cold moulded rop stretching hook
-  Crochet tendeur de cord moulé à froid
-  Gancho tiracuerda estampado a frio
-  Kalt bedruckt Spannhaken aus verzinktem Stahl

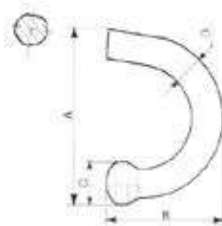

Materiale: Acciaio Grezzo Lucido

Art.	A	B	C	D	Peso(g)	Imb.
403/8	52	39	11	8	32	300
403/10	58	40	14	10	56	200
403/13	70	46	17	13	110	150

**Taschetta** Art. 413 - 414

-  Pocket
-  Poche
-  Bolsillo
-  Rungentasche

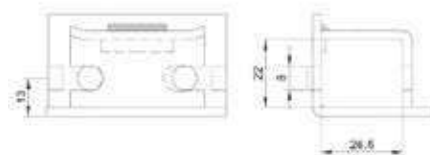

Materiale: Acciaio Zincato

Art.	Var.	Peso(g)	Conf.
413	Zincata / Bugne	65	200
414	Grezza / Piana	65	200

## Struttura dei codici e tabelle

### Indicazioni codici

L'esempio riportato di seguito semplifica l'apprendimento sulla struttura dei codici riportati in questo catalogo.

1°	2°	3°	4°	5°	6°	7°	8°	9°	10°	11°	12°	13°	14°
LE	2	2	2	2	D	0	2	1	5	0	2	1	

<p><b>Luigi Erba</b></p> <p>4 cifre EX cod. Luigi Erba</p> <p>D= destra S= sinistra 0= neutro</p>	<p><b>Finitura</b></p> <p>01= grezzo 02= ottonato 03= bronzato 75= tropicalizzato 76= zincato 77= zincato nero 81= nichelato</p>	<p><b>Lunghezza</b></p>	<p><b>Variante</b></p> <p>1= presente 2= assente</p>	<p><b>Imballo</b></p> <p>1= scatola 2= industriale 3= speciale</p>
---	--	-------------------------	--	--

### Indicazioni tabelle

L'esempio riportato di seguito semplifica l'apprendimento sulla struttura del catalogo.

<p><u>Immagine prodotto</u></p> 	<p><u>Codice tipologia prodotto</u></p> <p>Art. LE8242</p>	<p><u>Descrizione prodotto</u></p> <p><b>Chiusura a leva per lucchetto</b></p> <p>Peso articolo</p> <table border="1"> <thead> <tr> <th><u>Codice articolo</u></th> <th><u>Finitura articolo</u></th> <th><u>Peso</u></th> <th><u>Pezzi per confezione</u></th> </tr> <tr> <th>Art.</th> <th>Var.</th> <th></th> <th>Conf.</th> </tr> </thead> <tbody> <tr> <td>LE412100233021</td> <td>Ottonato</td> <td>9</td> <td>24</td> </tr> <tr> <td>LE412100243521</td> <td>Ottonato</td> <td>15</td> <td>24</td> </tr> <tr> <td>LE412108133021</td> <td>Nichelato</td> <td>9</td> <td>24</td> </tr> <tr> <td>LE412108143521</td> <td>Nichelato</td> <td>15</td> <td>24</td> </tr> </tbody> </table>	<u>Codice articolo</u>	<u>Finitura articolo</u>	<u>Peso</u>	<u>Pezzi per confezione</u>	Art.	Var.		Conf.	LE412100233021	Ottonato	9	24	LE412100243521	Ottonato	15	24	LE412108133021	Nichelato	9	24	LE412108143521	Nichelato	15	24
<u>Codice articolo</u>	<u>Finitura articolo</u>	<u>Peso</u>	<u>Pezzi per confezione</u>																							
Art.	Var.		Conf.																							
LE412100233021	Ottonato	9	24																							
LE412100243521	Ottonato	15	24																							
LE412108133021	Nichelato	9	24																							
LE412108143521	Nichelato	15	24																							

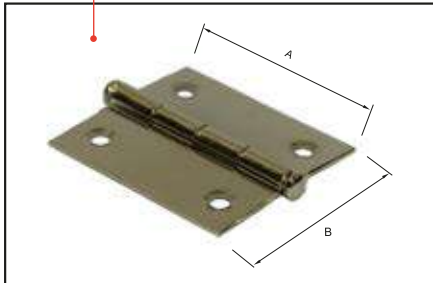
### Esempio esplicativo

In tutta questa zona si possono trovare numeri o descrizioni che indicano le caratteristiche tecniche/dimensionali degli articoli

## Elenco degli articoli presenti

- CERNIERE pag. 236
- ASTE SNODATE pag. 240
- CHIUSURE A LEVA pag. 242
- CATENACCI pag. 246
- FERRI DA LETTO pag. 248
- PERNI pag. 250
- VITERIA E GIUNZIONI pag. 254
- SUPPORTI E LASTRINE pag. 257

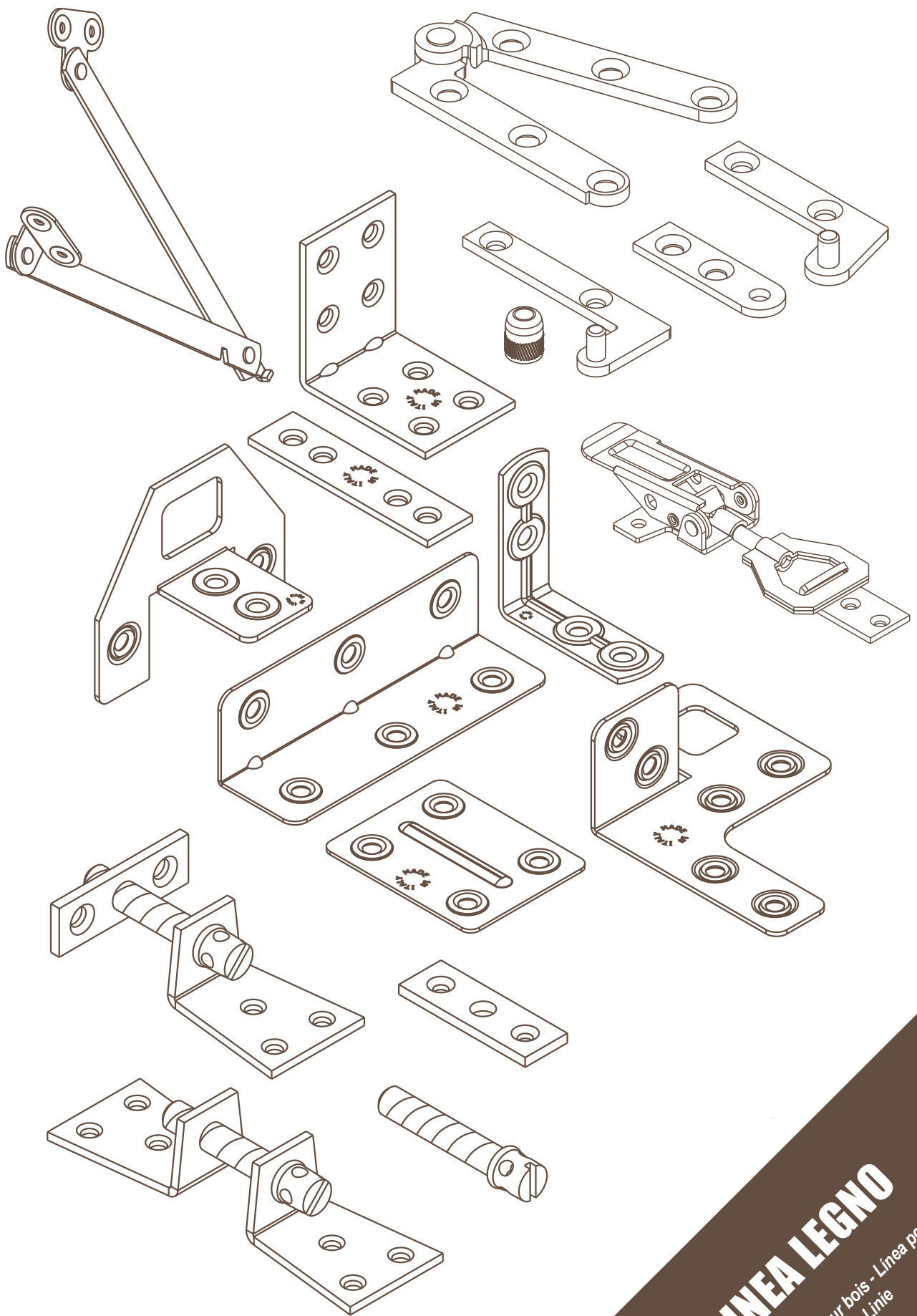

# LINEA LEGNO

Wood line - Ligne pour bois - Linea per madera  
Holz Linie

CATALOGO  
N.25

CERNIERE - HINGES

Art. LE4120

Cerniera con fori a spina fissa (su richiesta s/fori)

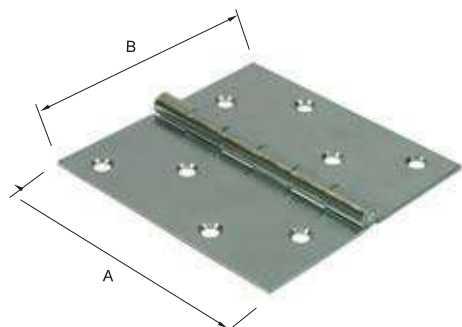

Hinge fixed pin - zinc plated steel, brassed steel (On request also without holes)
 Charnière goupille fixe - Acier zingué, acier laitonné (Production sans)

Bisagra con agujeros y pernio fijo (a petición sin agujeros)

Scharnier mit Löchern und festem Stift (ohne Löchern auf Anfrage)

Art.	Misure AxB	Ø spina	N.fori	Øfori	sp.	Peso (g)	Conf.	**=02 Ottonato	**=76 Zincato
LE4120 0**33021	30x30	2,5	2	3,5	0,9	9	100		
LE4120 0**43521	40x35	3	2	3,5	0,9	14	100		
LE4120 0**44021	40x40	3	3	3,5	0,9	15	100		
LE4120 0**54021	50x40	3	3	3	0,9	19	100		
LE4120 0**55021	50x50	3	3	3,5	0,9	23	100		
LE4120 0**65021	60x50	3	3	3,8	0,9	28	100		
LE4120 0**75521	70x55	4	3	4,3	1	44	100		
LE4120 0**86021	80x60	4	3	4,5	1,2	60	50		
LE4120 0**88021	80x80	4	4	4,5	1,2	77	50		

Art. LE4120A

Cerniera con fori tipo stretto spina fissa

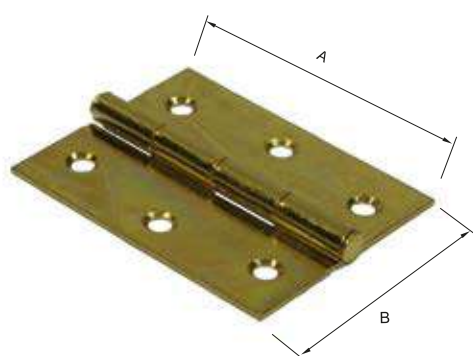

Hinge fixed pin - Zinked steel, brassed steel

Charnière goupille fixe - En acier zingué, acier laitonné

Bisagra con agujeros tipo estrecho pernio fijo

Schmales Scharnier mit Löchern und festem Stift

Art.	Misure AxB	Ø spina	N.fori	Øfori	sp.	Peso (g)	Conf.	**=02 Ottonato	**=76 Zincato
LE4120A **02521	25X22	2	2	4	0,9	5	200		
LE4120A **03021	30X22	2	2	3	0,9	6	100		
LE4120A **04021	40X25	2,5	2	3,5	0,9	10	100		
LE4120A **05021	50X30	2,5	3	3,9	0,9	15	50		
LE4120A **06021	60X31	3	3	3,5	0,9	20	100		
LE4120A **07021	70X36	3	3	3,8	0,9	28	50		

Art. LE4121

Cerniera con spina levare

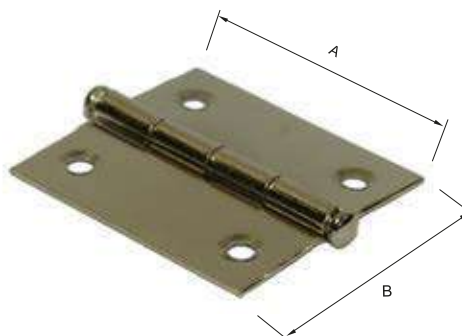

Hinge with loose pin - Brassed steel, nickel steel

Charnière avec goupille a lever - En acier laitonné, en acier nickelé

Bisagra con pernio a soltar

Scharnier mit losem Stift

Art.	Misure AxB	Ø spina	N.fori	Øfori	sp.	Peso (g)	Conf.	**=02 Ottonato	**=81 Nichelato
LE4121 0**33021	30x30	2,5	2	3,5	0,9	9	100		
LE4121 0**43521	40x35	3	2	3,5	0,9	15	50		
LE4121 0**44021	40x40	3	3	3,5	0,9	16	50		
LE4121 0**54021	50x40	3	3	3	0,9	20	50		
LE4121 0**55021	50x50	3	3	3,5	0,9	24	50		
LE4121 0**65021	60x50	3	3	3,8	0,9	28	50		
LE4121 0**75521	70x55	4	3	4,3	1	44	50		
LE4121 0**86021	80x60	4	3	4,5	1,2	63	50		
LE4121 0**88021	80x80	4	4	4,5	1,2	79	50		

Art. LE4121F

Cerniera con spina fissa

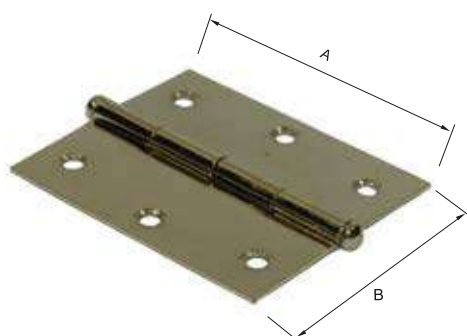

Hinge with fixed pin - Brassed steel, nickel steel

Charnière avec goupille fixe - En acier laitonné, en acier nickelé

Bisagra con pernio fijo

Scharnier mit festem Stift

Art.	Misure AxB	Ø spina	N.fori	Øfori	sp.	Peso (g)	Conf.	**=02 Ottonato	**=81 Nichelato
LE4121F **33021	30x30	2,5	2	3,5	0,9	9	100		
LE4121F **43521	40x35	3	2	3,5	0,9	15	50		
LE4121F **44021	40x40	3	3	3,5	0,9	16	50		
LE4121F **54021	50x40	3	3	3	0,9	20	50		
LE4121F **55021	50x50	3	3	3,5	0,9	24	50		
LE4121F **65021	60x50	3	3	3,8	0,9	28	50		
LE4121F **75521	70x55	4	3	4,3	1	44	50		
LE4121F **86021	80x60	4	3	4,5	1,2	63	50		
LE4121F **88021	80x80	4	4	4,5	1,2	79	50		

Cerniera curva alta con spina levare

Art. LE4124

 Hinge with loose pin - Brassed steel, nickel plated steel
  Charnière goupille à lever - En acier laitonné, en acier nickélé

 Bisagra curva alta con pernio a soltar
  Scharnier mit ausziehbarem Stift

Art.	Misure AxB	Mano.	Øfori	sp.	Peso (g)	Conf.	**=02 Ottonato	**=75 Tropical.	**=81 Nichelato
LE4124 D**43521	40x35	Dx	3,5	0,9	17	50			
LE4124 S**43521	40x35	Sx	3,5	0,9	17	50			
LE4124 D**54021	50x40	Dx	3,5	0,9	23	50			
LE4124 S**54021	50x40	Sx	3,5	0,9	23	50			

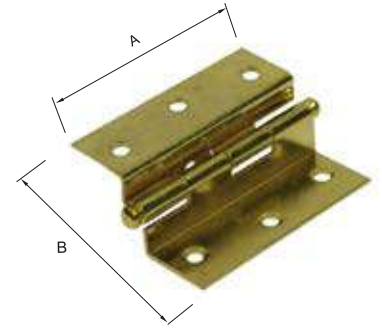

Cerniera a sfilare curva alta

Art. LE4125

 Hinge - Brassed steel, nickel plated steel
  Charnière coudée double - En acier laitonné, en acier nickélé

 Bisagra a soltar curva alta
  Scharnier mit ausziehbarem Stift

Art.	Misure AxB	Mano.	Øfori	sp.	Peso (g)	Conf.	**=02 Ottonato	**=81 Nichelato
LE4125 D**43521	40x35	Dx	3,5	0,9	17	50		
LE4125 S**43521	40x35	Sx	3,5	0,9	17	50		
LE4125 D**54021	50x40	Dx	3,5	0,9	23	50		
LE4125 S**54021	50x40	Sx	3,5	0,9	23	50		

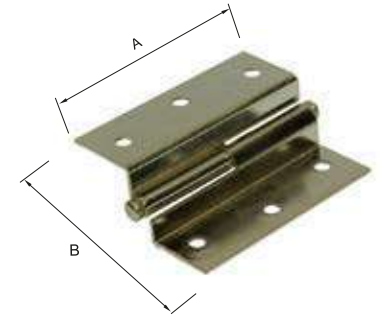

Cerniera a sfilare ala piana

Art. LE4125P

 Hinge - Brassed steel
  Charnière - En acier laitonné
  Bisagra a soltar ala llana

 Scharnier mit ausziehbarem Stift und flachen Flügeln

Art.	Misure AxB	Ø spina	Øfori	sp.	Peso (g)	Conf.
LE4125P 0254D21	50x42	3	4	1,3	28	50
LE4125P 0254S21	50x42	3	4	1,3	28	50

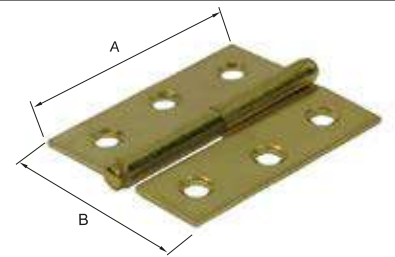

Cerniera a spina fissa

Art. LE4252

 Hinge fixed pin - Zinc. plated steel, tropicalized steel
  Charnière goupille fixe - En acier zingué, acier bichromatisé

 Bisagra con pernio fijo
  Scharnier mit festem Stift

Art.	Misure AxB	Ø spina	N.fori	Øfori	sp.	Peso (g)	Conf.	**=76 Zincato	**=75 Tropicalizzato
LE4252 0**10021	100x44	5	3	5,5	2	85	50		
LE4252 0**15021	150x44	5	3	5,5	2	116	50		
LE4252 0**20021	200x44	5	4	5,5	2	150	50		

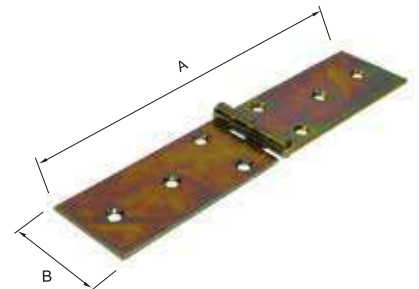

Cerniera pesante a spina fissa con ali ravvicinate

Art. LE4253

 Heavy hinge fixed pin with narrowed wings - Zinked steel
  Charnière lourde goupille fixe ailes rapprochées en acier zingué

 Bisagra pesada pernio fijo con alas cercanas
  Massive Scharnier mit festigen Stift und schmalen Flügeln

Art.	Misure AxB	Ø spina	N.fori	Øfori	sp.	Peso (g)	Conf.	**=01 Grezzo	**=76 Zincato
LE4253 0**43521	40x35	3	2	4,3	1,3	18	50		
LE4253 0**44021	40x40	3	3	4	1,3	23	50		
LE4253 0**54021	50x40	3	3	4,2	1,3	28	50		
LE4253 0**65021	60x50	3	3	5	1,3	38	50		

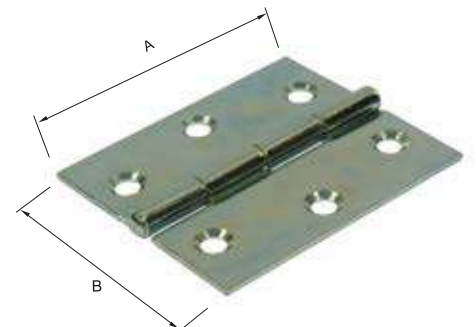

Art. LE4253D

Cerniera spina fissa (prodotta su richiesta)

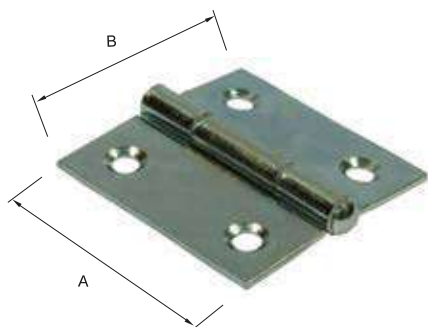

🇬🇧 Hinge fixed pin - Zinc plated steel (Produced on request only)
 🇫🇷 Charnière goupille fixe - En zinqué (Production sur commandé)

🇪🇸 Bisagra pernio fijo (Producida a petición)
 🇩🇪 Scharnier mit festem Stift (auf Anfrage hergestellt)

Art.	Misure Ax B	Var.	Ø spina	N.fori	Øfori	sp.	Peso (g)	Conf.
LE4253D 7654021	50x40	Zincata	3	2	5	1,3	26	50
LE4253D 7655021	50x50	Zincata	3	3	4	1,3	31	50
LE4253D 7655011	50x50	Zincata	3	3	5	1,3	31	50
LE4253D 7666421	64x63	Zincata	3	3	4,5	1,5	56	50

Art. LE4254

Cerniera a spina fissa

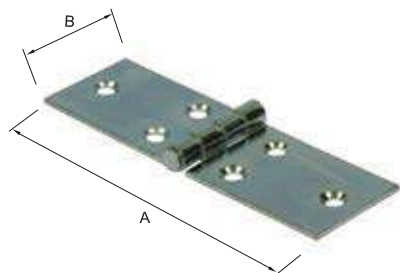

🇬🇧 Hinge fixed pin - Plain steel, zinc.
 🇫🇷 Charnière goupille fixe - En acier zinqué
 🇪🇸 Bisagra con pernio fijo

🇩🇪 Scharnier mit festem Stift

Art.	Misure Ax B	Ø spina	N.fori	Øfori	sp.	Peso (g)	Conf.	**=01 Grezzo	**=76 Zincato
LE4254 0**04021	40x25	3	3	3,2	1,3	13	100		
LE4254 0**05021	50x25	3	3	3,2	1,3	16	100		
LE4254 0**06021	60x25	3	3	3,2	1,3	17	100		
LE4254 0**08021	80x25	3	3	3,2	1,3	23	100		
LE4254 0**10021	100x25	3	3	4	1,3	27	100		
LE4254 0**12021	120x25	3	3	3,2	1,3	33	100		
LE4254 0**14021	140x29	4	4	4	1,5	46	100		
LE4254 0**16021	160x29	4	4	4,5	1,5	59	50		

Art. LE4277

Cerniera a biscotto

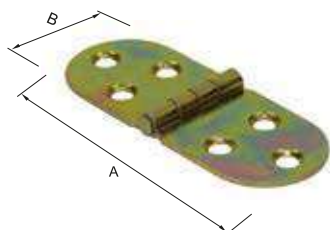

🇬🇧 Hinge - Brass steel, nicked steel
 🇫🇷 Charnière - En acier laitonné, en acier nickelé
 🇪🇸 Bisagra galleta

🇩🇪 Kistenband Scharnier

Art.	Misure Ax B	Ø spina	Øfori	sp.	Peso (g)	Conf.	**=01 Grezzo	**=02 Ottonato	**=75 Tropical.	**=81 Nichelato
LE4277 0**00021	80x31	3	6	1,5	30	100				

Art. LE4310

Cerniera regolabile Ø40mm



🇬🇧 Adjustable hinge diam. 40 mm. - Brass steel, zinc plated steel, nicked steel
 🇫🇷 Charnière réglable diam. 40 mm. - En acier laitonné, en acier zinqué, en acier bruni, en acier nickelé

🇪🇸 Bisagra regulable Ø40mm
 🇩🇪 Verstellbares Scharnier Ø 40mm

Art.	Misure	Ø spina	Øfori	sp.	Peso (g)	Conf.	**=02 Ottonato	**=81 Nichelato
LE4310 0**00021	Ø 40	3	5	1,3	16	100		

Art. LE4312

Cerniera rotonda con spina fissa

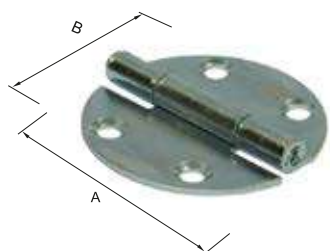

🇬🇧 Round hinge fixed pin Brass steel, zinc plated steel, burnished steel
 🇫🇷 Charnière ronde avec goupille fixe En acier laitonné, en acier zinqué, en acier bruni
 🇪🇸 Bisagra redonda con pernio fijo

🇩🇪 Rundes Scharnier mit Kurbel Vaus vernickeltem Stahl, verbronztem Stahl. Mit festem Stift.

Art.	Misure	Ø spina	Øfori	sp.	Peso (g)	Conf.	**=01 Grezzo	**=02 Ottonato	**=77 Zincato nero	**=81 Nichelato
LE4312 0**00021	Ø 40	3	5	1,3	18	100				

**Cerniera 30x48mm**

Art. LE4316

Hinge h.30x48 mm. **Brassed steel, nicked steel, bronzed steel**
 Charnière 30x48 mm. - **En acier laitonné, en acier nickelé en acier bronzé**
 Bisagra 30x48mm

Gerundetes Scharnier aus **Stahl, vernickeltem Stahl, verbronztem Stahl 30x48 mm.**

Art.	Misure AxB	Ø spina	Øfori	sp.	Peso (g)	Conf.	**=02	**=81	**=03
LE4316 0**00021	30x48	3	5	1,5	17	50			

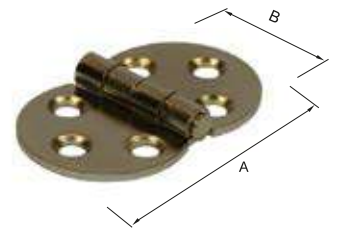

**Cerniera con cava 30x48mm**

Art. LE4317

Hinge with cranck 30x48 mm. **Brassed steel, nicked steel, bronzed steel**
 Charnière avec gorge 30x48 mm.- **En acier laitonné, en acier nickelé, en acier bronzé**
 Bisagra con hueco 30x48mm

Scharnier mit Kurbel aus **vernickeltem Stahl, verbronztem Stahl. 30x48 mm.**

Art.	Misure AxB	Ø spina	Øfori	sp.	Peso (g)	Conf.	**=02	**=81	**=03
LE4317 0**34821	30x48	3	5	1,5	16	50			

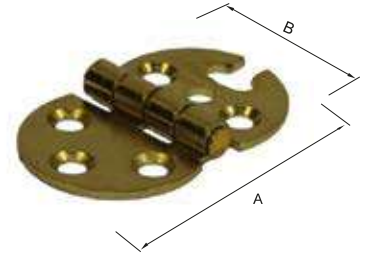

**Cerniera pesante con spina levare**

Art. LE4332

Heavy hinge loose pin - **zinc plated steel**
 Charnière lourde goupille à lever - **en acier zingué**
 Bisagra pesada con pernio a soltar

Schwerlastscharnier mit Langlöchern und Stift

Art.	Misure AxB	Var.	Ø spina	N.fori	sp.	Peso(g)	Conf.
LE4332 07655021	50x50	Zincata	4,5	2	1,5	41	50
LE4332 07665521	65x65	Zincata	5,3	3	2	86	24
LE4332 07677521	75x75	Zincata	6	3	2	130	24
LE4332 07697621	90x76	Zincata	6,8	3	2,5	198	24
LE4332 07699021	90x90	Zincata	6,8	3	2,5	220	12

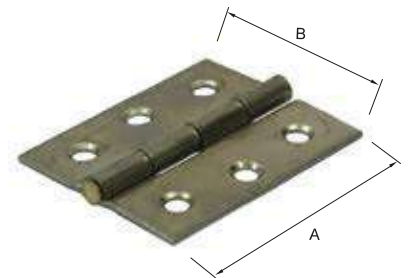

**Cerniera INOX spessore 0,9 mm**

Art. LE4920

Stainless steel hinge thickness 0,9 mm.
 Charnière Inox épaisseur 0,9 mm.

Bisagra INOX espesor 0,9mm
 Edelstahlscharnier. Dicke 0,9 mm

Art.	Misure AxB	Var.	Ø spina	N.fori	Øfori	sp.	Peso(g)	Conf.	
LE4920 03133021	30x30	Inox	2,5	2	3	0,9	9	50	← INOX
LE4920 03143521	40x35	Inox	3	2	3,5	0,9	15	50	← INOX
LE4920 03144021	40x40	Inox	3	3	3,5	0,9	16	50	← INOX
LE4920 03154021	50x40	Inox	3	3	3,5	0,9	20	50	← INOX
LE4920 03155021	50x50	Inox	3	3	3,5	0,9	24	50	← INOX
LE4920 03165021	60x50	Inox	3	3	4,3	0,9	28	50	← INOX

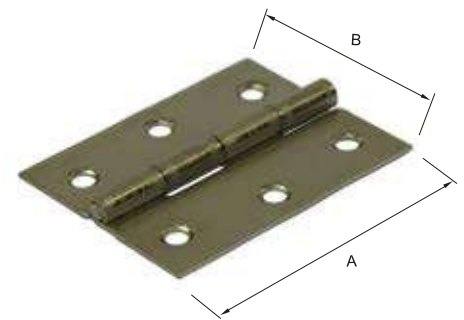

**Cerniera INOX spessore 1,2mm**

Art. LE4950

Stainless steel hinge thickness 1,2 mm.
 Charnière Inox épaisseur 1,2 mm.

Bisagra INOX espesor 1,2mm
 Edelstahlscharnier. Dicke 1.2 mm.

Art.	Misure AxB	Var.	Ø spina	N.fori	Øfori	sp.	Peso(g)	Conf.	
LE4950 03143521	40x35	Inox	3	2	2	1,2	19	24	← INOX
LE4950 03144021	40x40	Inox	3	3	3	1,2	21	24	← INOX
LE4950 03154021	50x40	Inox	3	3	3	1,2	25	24	← INOX
LE4950 03155021	50x50	Inox	3	3	3	1,2	30	24	← INOX
LE4950 03165021	60x50	Inox	3	3	3	1,2	36	24	← INOX

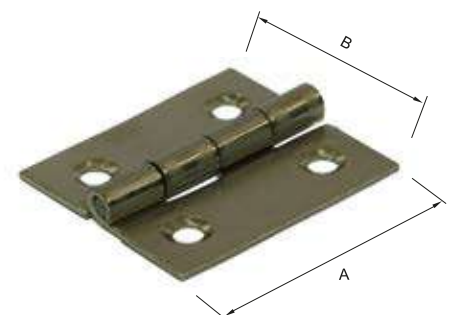



ASTE SNODATE - STAKES WITH SNODE

Art. LE2209

Snodo ad asta tonda



🇬🇧 Round rod joint

🇫🇷 Joint avec tige ronde

🇪🇸 Juntura con varilla redonda

🇩🇪 Rundstabgelenk

Art.	A	Peso (g)	Conf.	**=03	**=75	**=81
				Bronzato	Tropicalizzato	Nichelato
LE2209 0**15021	150	47	50			
LE2209 0**20021	200	54	50			
LE2209 0**25021	250	63	50			
LE2209 0**30021	300	70	50			

Art. LE2219

Asta senza terminali

10x1,6mm di spessore

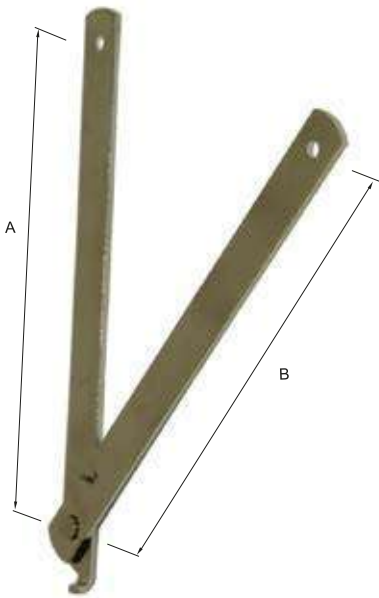

🇬🇧 Stay without hooks -  
Brassed steel, nickel plated steel,

🇫🇷 Compas-En acier laitoné, en acier nickelé

🇪🇸 Brazos de sujeción

🇩🇪 Klappenhalter ohne Befestigungsplatten,  
aus vermessingtem oder vernickeltem Stahl

Art.	Misure A+B	Mano	Peso (g)	Conf.	**=02	**=81
					Ottonato	Nichelato
LE2219 D**15021	150	Dx	19	100		
LE2219 S**15021	150	Sx	19	100		
LE2219 D**18021	180	Dx	25	100		
LE2219 S**18021	180	Sx	25	100		
LE2219 D**20021	200	Dx	27	100		
LE2219 S**20021	200	Sx	27	100		
LE2219 D**25021	250	Dx	35	100		
LE2219 S**25021	250	Sx	35	100		
LE2219 D**30021	300	Dx	43	100		
LE2219 S**30021	300	Sx	43	100		

Art. LE2220

Asta snodata

10x1,6mm di spessore

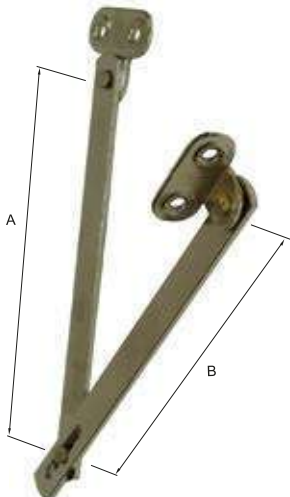

🇬🇧 Stay -

🇫🇷 Compas

🇪🇸 Brazos de sujeción

🇩🇪 Klappenhalter mit Befestigungsplatten,  
aus verzinktem Stahl

Art.	Misure A+B	Peso (g)	Conf.	**=75	**=81
				Tropicalizzato	Nichelato
LE2220 0**15021	150	30	50		
LE2220 0**20021	200	36	50		
LE2220 0**25021	250	41	50		
LE2220 0**30021	300	46	50		

Asta snodata con fermo

Art. LE2222

Stay -  
Brassed steel, nickel plated steel

Compas -  
En acier laitonné, en acier nickelé

Brazos de sujeción

Klappenhalter mit Befestigungsplatten

Art.	Misure A+B	Mano	Peso (g)	Conf.	**=02 Ottonato	**=81 Nichelato
LE2222 D**10021	100	Dx	21	50		
LE2222 S**10021	100	Sx	21	50		
LE2222 D**12021	120	Dx	28	50		
LE2222 S**12021	120	Sx	28	50		
LE2222 D**15021	150	Dx	30	50		
LE2222 S**15021	150	Sx	30	50		
LE2222 D**18021	180	Dx	34	50		
LE2222 S**18021	180	Sx	34	50		
LE2222 D**20021	200	Dx	35	50		
LE2222 S**20021	200	Sx	35	50		
LE2222 D**25021	250	Dx	43	50		
LE2222 S**25021	250	Sx	43	50		
LE2222 D**30021	300	Dx	51	50		
LE2222 S**30021	300	Sx	51	50		

10x1,6m di spessore

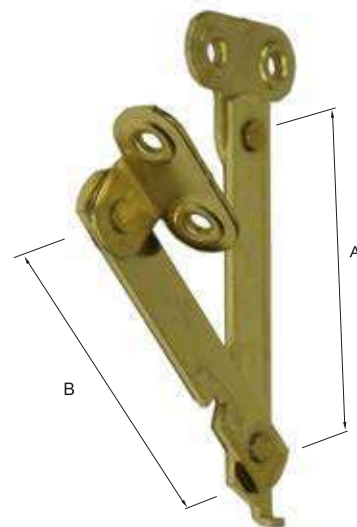

Asta snodata con fermo senza terminali

Art. LE2397

Stay -  
Zinc plated steel

Compas à arrêt -  
En acier zingué

Brazos de sujeción

Klappenhalter mit Arretierung ohne  
Befestigungsplatte aus verzinktem Stahl

Art.	Misure A+B	Mano	Peso (g)	Conf.	**=02 Ottonato	**=76 Zincato
LE2397 D**18021	180	Dx	48	100		
LE2397 S**18021	180	Sx	48	100		
LE2397 D**20021	200	Dx	54	100		
LE2397 S**20021	200	Sx	54	100		
LE2397 D**25021	250	Dx	66	100		
LE2397 S**25021	250	Sx	66	100		
LE2397 D**30021	300	Dx	77	100		
LE2397 S**30021	300	Sx	77	100		

15x2mm di spessore

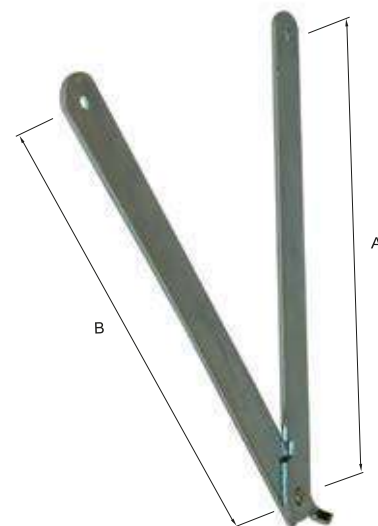

Asta snodata con fermo

Art. LE2398

Stay -  
Brassed steel, nickel plated steel

Compas -  
En acier laitonné, en acier nickelé

Brazos de sujeción

Klappenhalter mit Arretierung,  
aus vermessingtem oder vernickeltem  
Stahl

Art.	Misure A+B	Mano	Peso (g)	Conf.	**=02 Ottonato	**=81 Nichelato
LE2398 D**18021	180	Dx	64	50		
LE2398 S**18021	180	Sx	64	50		
LE2398 D**20021	200	Dx	72	50		
LE2398 S**20021	200	Sx	72	50		
LE2398 D**25021	250	Dx	83	50		
LE2398 S**25021	250	Sx	83	50		
LE2398 D**30021	300	Dx	96	24		
LE2398 S**30021	300	Sx	96	24		

15x2mm di spessore

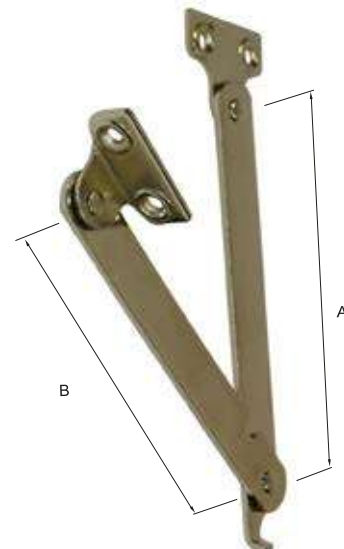





**CHIUSURE A LEVA - LEVER LOCKING**

**Art. LE8242**

**Chiusura a leva per lucchetto**







-  *Lever locking for padlock - Nickel plated steel, zinc. plated steel,*
-  *Fermeture à levier pour cadenas - En acier nickelé, en acier zingué,*
-  *Cierre de palanca cincada, niquelada*
-  *Heberverschluß mit gekröpftem Schließhaken für Vorhängeschloss*

Art.	Var.	Peso(g)	Conf.
<b>LE8242 08100021</b>	Nichelato	32	100
<b>LE8242 07600021</b>	Zincato	32	100

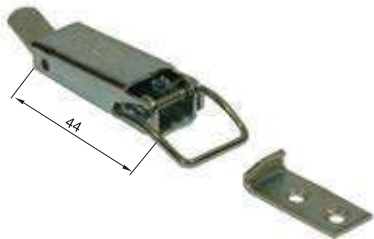
**Art. LE8243**

**Chiusura a leva**







-  *Lever locking - Nickel plated steel, zinc. plated steel,*
-  *Fermeture à levier - En acier nickelé, en acier zingué,*
-  *Cierre de palanca cincada, niquelada*
-  *Heberverschluß mit gekröpftem Schließhaken*

Art.	Var.	Peso(g)	Conf.
<b>LE8243 08100021</b>	Nichelato	32	100
<b>LE8243 07600021</b>	Zincato	32	100

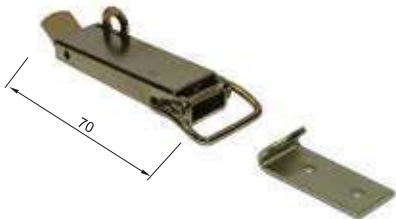
**Art. LE8355**

**Chiusura a leva**







-  *Lever locking for padlock - Nickel plated steel, zinc. plated steel,*
-  *Fermeture à levier pour cadenas - En acier nickelé, en acier zingué,*
-  *Cierre de palanca cincada, niquelada*
-  *Heberverschluß mit gekröpftem Schließhaken für Vorhängeschloss*

Art.	Var.	Peso(g)	Conf.
<b>LE8355 08100021</b>	Nichelato	120	100
<b>LE8355 07600021</b>	Zincato	120	100

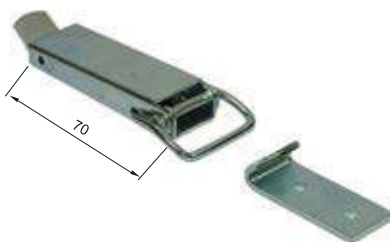
**Art. LE8360**

**Chiusura a leva**



-  *Lever locking - Nickel plated steel, zinc. plated steel,*
-  *Fermeture à levier - En acier nickelé, en acier zingué,*
-  *Cierre de palanca cincada, niquelada*
-  *Heberverschluß mit gekröpftem Schließhaken*

Art.	Var.	Peso(g)	Conf.
<b>LE8360 08100021</b>	Nichelato	118	100
<b>LE8360 07600021</b>	Zincato	118	100

**Chiusura tipo pesante 90mm**

Art. LE8328





-  Lever locking 90mm  
Nickelated steel, Zinked steel
-  Fermeture à levier 90mm  
En acier nickelé, en acier zingué
-  Cierre de palanca cincada,  
niquelada
-  Massiver Hebelverschluss 90mm  
mit gekröpftem Schließhaken

Art.	Var.	Peso(g)	Conf.
LE8328 08100021	Nichelato	189	50
LE8328 07600021	Zincato	189	25



**Chiusura tipo pesante 90mm portalucchetto**

Art. LE8331



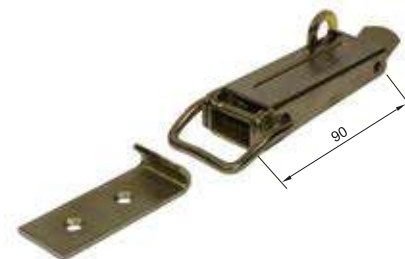

-  Lever locking 90mm for padlock  
Nickelated steel, Zinked steel
-  Fermeture à levier 90mm pour  
cadenas En acier nickelé, en acier zingué
-  Cierre de palanca cincada,  
niquelada
-  Massiver Hebelverschluss 90mm  
für Vorhängeschloss

Art.	Var.	Peso(g)	Conf.
LE8331 08100021	Nichelato	190	25
LE8331 07600021	Zincato	190	50



**Chiusura a leva**

Art. LE8244





-  Lever locking -  
Nickel plated steel, zinc. plated steel
-  Fermeture à levier -  
En acier nickelé, en acier zingué
-  Cierre de palanca cincada,  
niquelada
-  Hebelverschluss mit gekröpftem  
Schließhaken

Art.	Var.	Peso(g)	Conf.
LE8244 08100021	Nichelato	20	100
LE8244 07600021	Zincato	20	100



**Chiusura a leva per lucchetto**

Art. LE8288

-  Lever locking for padlock -  
nickel plated steel, zinc plated steel
-  Fermeture a' levier pour cadenas -  
En acier nickelé, en acier zingué
-  Cierre de palanca cincada,  
niquelada
-  Hebelverschluss mit gekröpftem  
Schließhaken für Vorhängeschloss

Art.	Var.	Peso(g)	Conf.
LE8288 08100021	Nichelato	22	100
LE8288 07600021	Zincato	22	100



**Art. LE8289**

**Chiusura a leva**



*Lever locking - nickel plated steel, zinc plated steel*

*Fermeture à levier - En acier nickelé, en acier zingué*

*Cierre de palanca cincada, níquelada*

*Hebelschluß mit gekröpftem Schließhaken*

Art.	Var.	Peso(g)	Conf.
LE8289 08100021	Nichelato	22	100
LE8289 07600021	Zincato	22	100

**Art. LE8301**

**Chiusura**

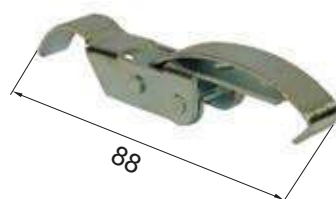

*Lever locking - Zinc plated steel*

*Fermeture à levier - En acier zingué*

*Cierre de palanca cincada,*

*Hebelschluß mit gekröpftem Schließhaken*

Art.	Var.	Peso(g)	Conf.
LE8301 07600021	Zincato	30	100

**Art. LE8350**

**Chiusura regolabile con incontro (base a 3 fori)**

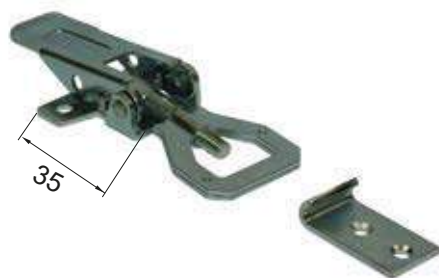

*Lever locking with strike (Base with 3 holes) - Zinc plated steel*





*Fermeture à levier avec cage (Base avec 3 trous) - En acier zingué*

*Cierre de palanca cincada,*

*Einstellbarer Hebelschluß mit gekröpftem Schließhaken und Auflaufschuh (3 Loch-Grundplatte)*

Art.	Var.	Peso(g)	Conf.
LE8350 07600021	Zincato	102	25





**Chiusura reg. p.lucchetto c/incontro (Base a 2 fori) Art. LE8351**

-  *Lever locking for padlock with strike (Base with 2 holes) - Zinc plated steel*
-  *Fermeture à levier pour cadenas avec cage (Base avec 2 trous) - En acier zingué*
-  *Cierre de palanca cincada,*
-  *Verstellbarer Hebelverschluss für Vorhängeschloss mit Auflaufschuh (2 Loch-Grundplatte )*

Art.	Var.	Peso(g)	Conf.
LE8351 07600021	Zincato	100	25







**Chiusura regolabile c/incontro (Base a 2 fori) Art. LE8352**

-  *Lever locking with strike (Base with 2 holes) - Zinc plated steel*
-  *Fermeture à levier avec cage (Base avec 2 trous) - En acier zingué*
-  *Cierre de palanca cincada,*
-  *Verstellbarer Hebelverschluss mit Auflaufschuh (2 Loch-Grundplatte )*

Art.	Var.	Peso(g)	Conf.
LE8352 07600021	Zincato	97	25



**Chiusura a leva grande (Solo su richiesta) Art. LE8340**

-  *Big lever locking - zink plated steel (only on request)*
-  *Fermeture au levier grand En acier zingué (seul sur demande)*
-  *Cierre de palanca cincada,*
-  *Langer Hebelverschluss (nur auf Anfrage)*

Art.	Var.	Peso(g)	Conf.
LE8340 07600021	Zincato	226	25

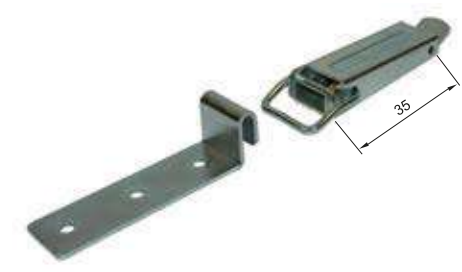

Applicazione utilizzando Art. LE8350



Applicazione utilizzando Art. LE8244



Applicazione utilizzando Art. LE8242



CATENACCI - BOLTS

Art. LE6131

Catenaccio a filo

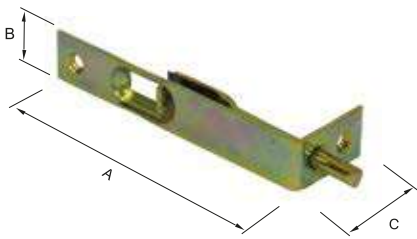

Forniture bolt  
Tropicalized steel

Verrou de meuble  
En acier bichromatisé

Pestillo a hilo

Möbel-Kantriegel aus topikalisiertem Stahl

Art.	Misure AxBxC	Sp.	Var.	Peso(g)	Conf.
LE6131 07506021	60x12x22	1,2	Tropicalizzato	14	100
LE6131 07507021	70x12x22	1,2	Tropicalizzato	16	100
LE6131 07508021	80x12x22	1,2	Tropicalizzato	18	100
LE6131 07510021	100x12x22	1,2	Tropicalizzato	23	100
LE6131 07512021	120x12x22	1,2	Tropicalizzato	27	50
LE6131 07514021	140x12x22	1,2	Tropicalizzato	32	100

Art. LE6132

Catenacciolo

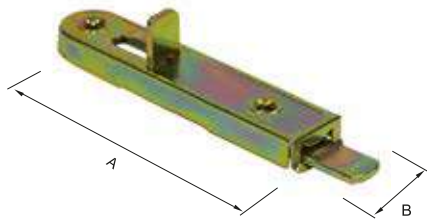

Forniture bolt  
Tropicalized steel

Verrou de meuble  
En acier bichromatisé

Pestillo

Türriegel mit Schraubendreher  
Schlitz aus topikalisiertem Stahl

Art.	Misure AxB	Var.	Peso(g)	Conf.
LE6132 07600021	75x15	Zincato	14	100
LE6132 07500021	75x15	Tropicalizzato	14	100

Art. LE6133

Catenacciolo a scatto

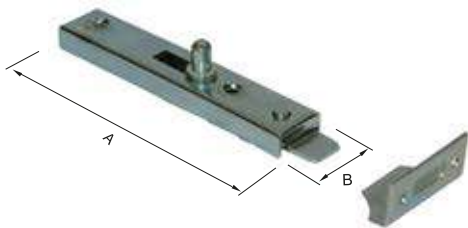

Automatic furniture bolt  
Tropicalized steel

Automatique verrou de meuble  
En acier bichromatisé

Pestillo con salto

Schnappverschluss aus  
topikalisiertem Stahl

Art.	Misure AxB	Var.	Peso(g)	Conf.
LE6133 07600021	75x15	Zincato	30	100
LE6133 07500021	75x15	Tropicalizzato	30	100

Art. LE6135

Catenacciolo con corsa piegata

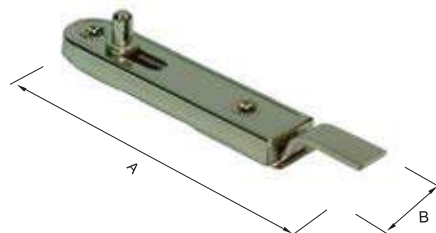

Forniture bolt

Verrou de meuble

Pestillo con salto

Schnappverschluss aus  
topikalisiertem Stahl

Art.	Misure AxB	Var.	Peso(g)	Conf.
LE6135 07600021	75x15	Zincato	19	100
LE6135 07500021	75x15	Tropicalizzato	19	100

Catenaccio a leva

Art. LE6157

 *Lever bolt*  
*Brass steel, bronzed steel*

 *Verrou à levier*  
*En acier laitoné, en acier*

 *Pestillo con palanca*

 *Kantriegel mit Hebel*

Art.	Misure AxB+C	Var.	Peso(g)	Conf.
LE6157 00201521	150x21 +41	Ottonato	109	12
LE6157 00202021	200x21 +41	Ottonato	129	12
LE6157 00202521	250x21 +41	Ottonato	156	12
LE6157 00203021	300x21 +41	Ottonato	175	6
LE6157 00203521	350x21 +41	Ottonato	203	6
LE6157 00204021	400x21 +41	Ottonato	230	6
LE6157 00301521	150x21 +41	Bronzato	109	12
LE6157 00302021	200x21 +41	Bronzato	129	12
LE6157 00302521	250x21 +41	Bronzato	156	12
LE6157 00303021	300x21 +41	Bronzato	175	6
LE6157 00303521	350x21 +41	Bronzato	203	6
LE6157 00304021	400x21 +41	Bronzato	230	6
LE6157 00101521	150x21 +41	Grezzo	109	12
LE6157 00102021	200x21 +41	Grezzo	129	12
LE6157 00102521	250x21 +41	Grezzo	156	12
LE6157 00103021	300x21 +41	Grezzo	175	6
LE6157 00103521	350x21 +41	Grezzo	203	6
LE6157 00104021	400x21 +41	Grezzo	230	6



Catenaccio a coda tipo pesante

Art. LE6159A

 *Bolt heavy type Steel*

 *Verrou lourd En acier*

 *Pestillo a cola tipo pesado*

 *Massiver Bolzenriegel*

Art.	Misure	Var.	Peso(g)	Conf.
LE6159A 0101521	150	Grezzo	291	12
LE6159A 0102021	200	Grezzo	327	12
LE6159A 0102521	250	Grezzo	368	12
LE6159A 0103021	300	Grezzo	410	12
LE6159A 0103521	350	Grezzo	450	12
LE6159A 0104021	400	Grezzo	508	6





FERRI DA LETTO - BED HOOKS

Art. LE3068

Ferro da letto



Bed hook - zinc plated steel

Equerre de lit - en acier zingué

Bisagra para cama

Bett Anschluss Ecke

Art.	Var.	Peso(g)	Conf.
LE3068 07600021	Zincato	73	50

Art. LE3095

Ferro da letto ad incastro



= 1 SET

Bed hook - zinc plated steel

Ferrure de lit - en acier zingué

Bisagra para cama

Garnitur Bettbeschlag aus verzinktem Stahl

Art.	Ø Fori	Misure	Num. Fori	Var.	Peso(g)	Conf.
LE3095 07609521	5,5	95	3	Zincato	329	25 set
LE3095 07612021	5,5	120	4	Zincato	412	25 set
LE3095 07615021	5,5	150	4	Zincato	500	25 set

Art. LE3098

Ferro da letto a 1 gancio



= 1 SET

Bed hook with one hooks - zinc plated steel

Ferrure de lit avec un crochets - en acier zingué

Bisagra para cama

Garnitur Betthaken aus tropikalisiertem Stahl

Art.	Misure	Peso(g)	Conf.	**=01 Grezzo	**=76 Zincato
LE3098 0 ** 08021	80	49	48 set		
LE3098 0 ** 10021	100	59	48 set		

Art. LE3098A

Ferro da letto a 2 ganci



= 1 SET

Bed hook with two hooks - zinc plated steel

Ferrure de lit avec deux crochets - en acier zingué

Bisagra para cama

Garnitur Betthaken mit Hakenteil und Schlitzteil

Art.	Misure	Peso(g)	Conf.	**=01 Grezzo	**=76 Zincato
LE3098A ** 10021	100	61	48 set		
LE3098A ** 12021	120	64	48 set		
LE3098A ** 14021	140	73	48 set		
LE3098A ** 16021	160	83	48 set		

Art. LE3099

Ferro da letto con bordi stondati



= 1 SET

Bed hook Zinked steel

Ferrure de lit avec coins arrondis - En acier zingué

Bisagra para cama

Garnitur Betthaken mit Hakenteil und Schlitzteil, Ecken abgerundet.

Art.	Misure	N.ganci	Peso(g)	Conf.	**=01 Grezzo	**=76 Zincato
LE3099 0 ** 08021	80	1	41	48 set		
LE3099 0 ** 10021	100	2	53	48 set		
LE3099 0 ** 12021	120	2	62	48 set		
LE3099 0 ** 14021	140	2	71	48 set		

Ferro da letto a baionetta

Art. LE3110

🇬🇧 Bayonet bed hook -  
Zinc plated steel

🇫🇷 Ferrure de lit à baionette -  
En acier zingué

🇪🇸 Bisagra para cama

🇩🇪 Liegenhochstellbeschlag für Bett

Art.	Misure	Var.	Peso(g)	Conf.
LE3110 07602521	150x25	Zincato	105	50 set
LE3110 07604021	150x40	Zincato	189	50 set



= 1 SET

Ferro da letto con punta da 130mm

Art. LE3361

🇬🇧 Bed hook with points mm.130 -  
Tropicalized steel,

🇫🇷 Ferrure de lit avec pointes mm.130 -  
En acier bichromatisé,

🇪🇸 Bisagra para cama

🇩🇪 Garnitur Bettbeschlag mit 3 Haken  
aus tropikalisiertem Stahl. Länge 130mm

Art.	Var.	Peso(g)	Conf.
LE3361 07501321	Tropicalizzato	294	25 set



= 1 SET

Ferro da letto

Art. LE3363

🇬🇧 Bed hook -  
tropicalized steel

🇫🇷 Ferrure de lit -  
en acier bichromatisé

🇪🇸 Bisagra para cama

🇩🇪 Garnitur Bettverbinder aus  
tropikalisiertem Stahl

Art.	Var.	Peso(g)	Conf.
LE3363 07500021	Tropicalizzato	677	25 set



= 1 SET

Ferro da letto regolabile 140mm

Art. LE3365

🇬🇧 Adjustable bed hook mm.140 -  
Tropicalized steel

🇫🇷 Ferrure de lit réglable mm.140 -  
En acier bichromatisé

🇪🇸 Bisagra para cama

🇩🇪 Verstellbarer Bettbeschlag  
140mm aus tropikalisiertem Stahl

Art.	Var.	Piastra	Peso(g)	Conf.
LE3365 07500021	Tropicalizzato	4 fori	172	24 set



= 1 SET

Ferro da letto regolabile 140mm

Art. LE3366

🇬🇧 Adjustable bed hook mm.140 -  
Tropicalized steel, zinc plated steel

🇫🇷 Ferrure de lit réglable mm.140 -  
En acier bichromatisé, acier zingué

🇪🇸 Bisagra para cama

🇩🇪 Verstellbare Hardware für Bett  
140mm aus tropikalisiertem Stahl

Art.	Var.	Piastra	Peso(g)	Conf.
LE3366 07600021	Zincato	2 fori	153	24 set
LE3366 07500021	Tropicalizzato	2 fori	153	24 set



= 1 SET

PERNI - PIVOTS

Art. LE5108

Perno diritto con piastrina

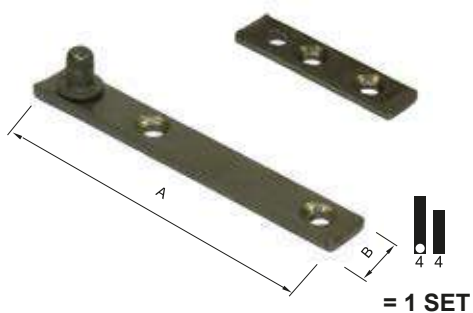

🇬🇧 Pivot -

🇫🇷 Pivot -

🇪🇸 Juego pivote con placa de fijación recta.

🇩🇪 Rechte Laufroll Zapfenband mit Platte

Art.	Misure AxB	Sp.	Peso(g)	Conf.	**=01 Grezzo	**=02 Ottonato	**=76 Zincato
LE5108 0** 05021	50x8	2,5	47	24 set			
LE5108 0** 06021	60x8	2,5	57	24 set			
LE5108 0** 07021	70x10	2,5	85	24 set			
LE5108 0** 08021	80x10	2,5	91	24 set			
LE5108 0** 09021	90x10	2,5	98	24 set			
LE5108 0** 10021	100x10	2,5	106	24 set			

Art. LE5111

Perno doppio a squadra

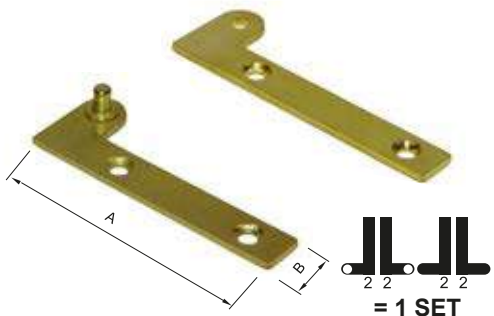

🇬🇧 Pivot -  
Brassed steel

🇫🇷 Pivot -  
En acier laitonné

🇪🇸 Juego pivote doble.  
Acero latonado

🇩🇪 Eckzapfenband mit Klobe und gleich langen Lappen (zwei Teilen), aus Messing

Art.	Misure AxB	Sp.	Var.	Peso(g)	Conf.
LE5111 00205021	50x10	2	Ottonato	73	24 set
LE5111 00206021	60x10	2	Ottonato	88	24 set
LE5111 00207021	70x10	2	Ottonato	97	24 set
LE5111 00208021	80x11	2,5	Ottonato	160	24 set

Art. LE5112

Perno a falsa squadra con bussole in ottone

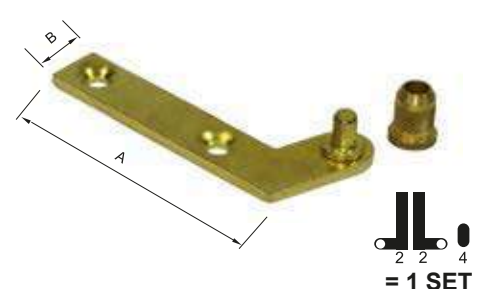

🇬🇧 Pivot with brass sleeve -  
Brassed steel

🇫🇷 Pivot avec douille en laiton -  
En acier laitonné

🇪🇸 Juego pivote con placa de 135° y buje. Acero latonado

🇩🇪 135° Eckzapfenband mit Buchse, aus Messing

Art.	Misure AxB	Sp.	Var.	Peso(g)	Conf.
LE5112 00205021	50x10,5	2	Ottonato	50	24 set
LE5112 00206021	60x11,5	2	Ottonato	72	24 set
LE5112 00207021	70x11,5	2,5	Ottonato	79	24 set
LE5112 00208021	80x11	2,5	Ottonato	87	24 set

Art. LE5113

Perno eccentrico

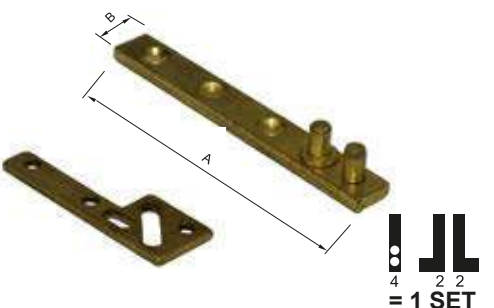

🇬🇧 Pivot -  
Tropicalized steel

🇫🇷 Pivot -  
En acier bichromatisé

🇪🇸 Juego pivote excéntrico, tropicalizado

🇩🇪 Exzenter Zapfenband

Art.	Misure AxB	Sp.	Var.	Peso(g)	Conf.
LE5113 07506521	65x8	3	Tropicalizzato	87	24 set
LE5113 07507521	75x9	3	Tropicalizzato	120	24 set
LE5113 07509021	90x10	3	Tropicalizzato	189	24 set

Art. LE5115

Perno a falsa squadra con piastrina

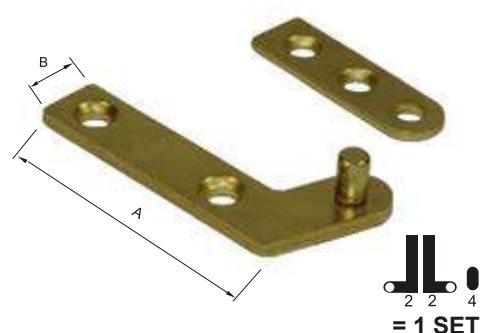

🇬🇧 Pivot -  
Brassed steel

🇫🇷 Pivot -  
En acier laitonné

🇪🇸 Juego pivote con placa de 135° y buje. Acero latonado

🇩🇪 135° Eckzapfenband mit Platte, aus Messing

Art.	Misure AxB	Sp.	Var.	Peso(g)	Conf.
LE5115 00205021	50x10,5	2	Ottonato	69	24 set
LE5115 00206021	60x11,5	2	Ottonato	90	24 set
LE5115 00207021	70x11,5	2,5	Ottonato	99	24 set
LE5115 00208021	80x11	2,5	Ottonato	108	24 set

Perno piegato con piastrina

Art. LE5116

UK Bended pivot with plate

FR Pivot courbé avec plaquette

ES Pasador plegado con placa

DE Verbogener Stift mit Platte

Art.	Misure Ax B	Sp.	Var.	Peso(g)	Conf.
LE5116 00205021	50x10	2	Ottonato	64	24 set
LE5116 00206021	60x10	2	Ottonato	66	24 set
LE5116 00207021	70x10	2	Ottonato	87	24 set
LE5116 00208021	80x11	2,5	Ottonato	108	24 set

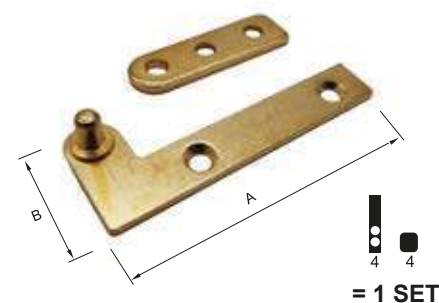

Perno piegato con bussola

Art. LE5116B

UK Bended pivot with compass

FR Pivot avec douille en laiton en acier laitoné

ES Pasador plegado con buje

DE Gebogener Stift mit Kompass

Art.	Misure Ax B	Sp.	Var.	Peso(g)	Conf.
LE5116B 0205021	50x10	2	Ottonato	47	24 set
LE5116B 0206021	60x10	2	Ottonato	52	24 set
LE5116B 0207021	70x10	2	Ottonato	67	24 set
LE5116B 0208021	80x11	2,5	Ottonato	93	24 set

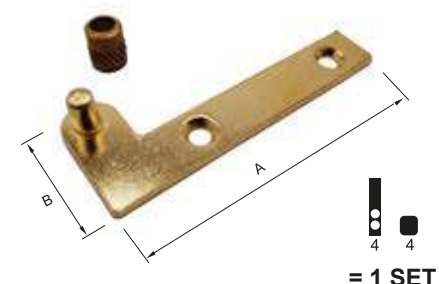

Perno eccentrico con piastra quadra

Art. LE5118

UK Pivot - Tropicalized steel

FR Pivot - En acier bichromatisé

ES Juego pivote excéntrico con placa cuadrada, tropicalizado

DE Exzenter Zapfenband mit viereckige Lochplatte

Art.	Misure Ax B	Sp.	Var.	Peso(g)	Conf.
LE5118 07506521	65x8	3	Tropicalizzato	87	24 set
LE5118 07507521	75x9	3	Tropicalizzato	115	24 set
LE5118 07509021	90x10	3	Tropicalizzato	164	24 set

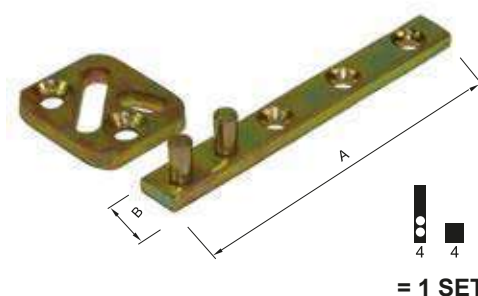

Perno diritto con bussola in ottone

Art. LE5119

UK Pivot with brass sleeve - Brassed steel

FR Pivot avec douille en laiton - En acier laitoné

ES Juego pivote con buje. Acero latonado

DE GeLaufrollee Zapfenband mit Buchse, aus Messing

Art.	Misure Ax B	Sp.	Var.	Peso(g)	Conf.
LE5119 00205021	50x8	2,5	Ottonato	43	24 set
LE5119 00206021	60x8	2,5	Ottonato	50	24 set
LE5119 00207021	70x10	2,5	Ottonato	66	24 set
LE5119 00208021	80x10	2,5	Ottonato	72	24 set
LE5119 00209021	90x10	2,5	Ottonato	79	24 set
LE5119 00210021	100x10	2,5	Ottonato	89	24 set

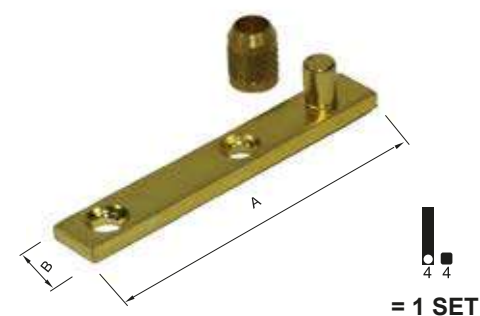

Perno eccentrico con piastra rotonda cava a "S"

Art. LE5175

UK Pivot - Tropicalized steel

FR Pivot - En acier bichromatisé

ES Juego pivote excéntrico con placa redonda con ojal S, tropicalizado

DE Exzenter Zapfenband mit runde „S“ Lochplatte

Art.	Misure Ax B	Sp.	Var.	Peso(g)	Conf.
LE5175 07506521	65x8	3	Tropicalizzato	93	24 set
LE5175 07507521	75x9	3	Tropicalizzato	122	24 set
LE5175 07509021	90x10	3	Tropicalizzato	157	24 set

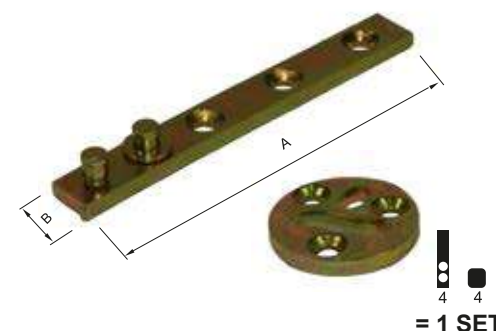

Art. LE5176

Perno eccentrico con piastra rotonda cava dritta

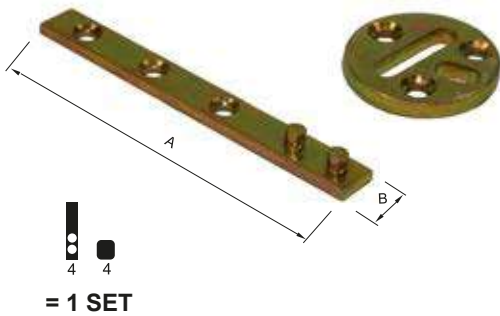

🇬🇧 Pivot -  
Tropicalized steel

🇪🇸 Juego pivote excéntrico con placa redonda con ojal S, tropicalizado

🇫🇷 Pivot -  
En acier bichromatisé

🇩🇪 Zapfenbänder mit runde S-Platte

Art.	Misure Ax B	Sp.	Var.	Peso(g)	Conf.
LE5176 07506521	65x8	3	Tropicalizzato	93	24 set
LE5176 07507521	75x9	3	Tropicalizzato	127	24 set
LE5176 07509021	90x10	3	Tropicalizzato	156	24 set

Art. LE5177

Perno eccentrico con piastra quadra cava a "S"

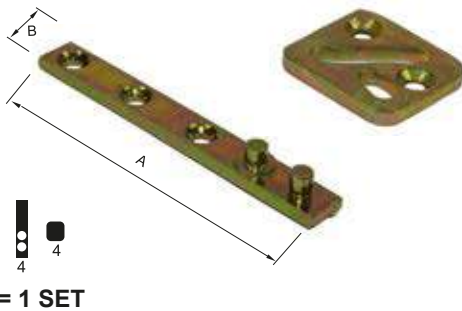

🇬🇧 Pivot -  
Tropicalized steel

🇪🇸 Juego pivote excéntrico con placa redonda con ojal recto, tropicalizado

🇫🇷 Pivot -  
En acier bichromatisé

🇩🇪 Exzenter Zapfenband mit runde Lochplatte

Art.	Misure Ax B	Sp.	Var.	Peso(g)	Conf.
LE5177 07506521	65x8	3	Tropicalizzato	85	24 set
LE5177 07507521	75x9	3	Tropicalizzato	114	24 set
LE5177 07509021	90x10	3	Tropicalizzato	162	24 set

Art. LE5214

Perno a squadra doppio tipo stretto

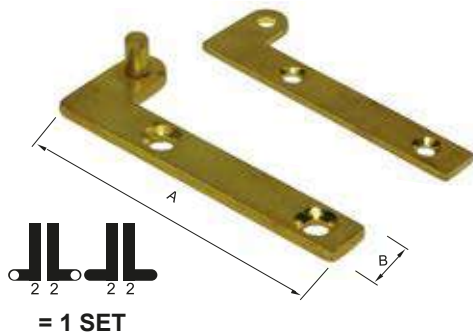

🇬🇧 Pivot narrow type -  
Brassed steel

🇪🇸 Juego pivote doble con placas de 90°, tipo estrecho. Acero latonado

🇫🇷 Pivot modèle étroit -  
En acier laitonné

🇩🇪 Eckzapfenband mit gleich langen Lappen (zwei teilen), aus Messing. Schmal Modell

Art.	Misure Ax B	Sp.	Var.	Peso(g)	Conf.
LE5214 00200021	55x8	2,5	Ottonato	79	24 set

Art. LE5215

Perno a squadra con piastrina tipo stretto

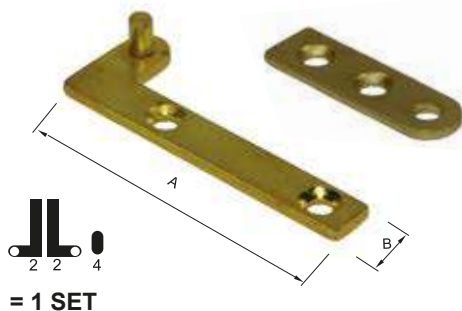

🇬🇧 Pivot narrow type -  
Brassed steel

🇪🇸 Juego pivote con placa de 90° tipo estrecho. Acero latonado

🇫🇷 Pivot modèle étroit -  
En acier laitonné

🇩🇪 Eckzapfenband mit Platte. Schmal Modell

Art.	Misure Ax B	Sp.	Var.	Peso(g)	Conf.
LE5215 00200021	55x8	2,5	Ottonato	54	24 set

Art. LE5215B

Perno a squadra con bussola in ottone tipo stretto

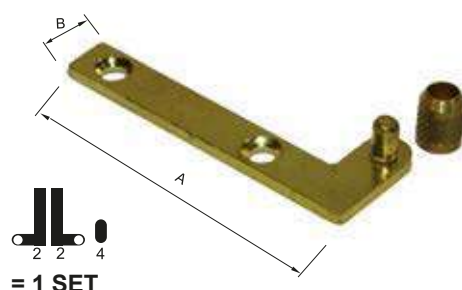

🇬🇧 Pivot with brass sleeve, narrow type -  
Brassed steel

🇪🇸 Juego pivote con placa de 90° y buje. Acero latonado

🇫🇷 Pivot type étroit avec douille en acier laitonné

🇩🇪 EKzapfenband Buchse. Schmal Typ

Art.	Misure Ax B	Sp.	Var.	Peso(g)	Conf.
LE5215B 0200021	55x8	2,5	Ottonato	50	24 set

**Perno per ribalta con bussola ottone**

Art. LE5266

Pivot with brass sleeve -  
Brassed steel

Pivot avec douille en laiton -  
En acier laitonné

Juego pivote con placa y buje en latón  
por hojas basculantes. Acero latonado

Eckzapfenband mit Buchse für  
Umkipfung, aus Messing.

Art.	Misure AxB	Sp.	Var.	Peso(g)	Conf.
LE5266 00200021	55x8	2,5	Ottonato	10	24 set

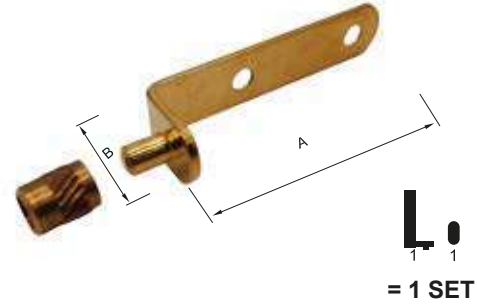

**Perno a falsa squadra c.piastrina, tipo stretto**

Art. LE5270

Pivot narrow type -  
Brassed steel

Pivot type étroit -  
En acier laitonné

Juego pivote con placa de ángulo obtuso  
y buje, tipo estrecho. Acero latonado

Eckzapfenband mit Platte.  
Schmal Modell

Art.	Misure AxB	Sp.	Var.	Peso(g)	Conf.
LE5270 00200021	55x8	2,5	Ottonato	52	24 set

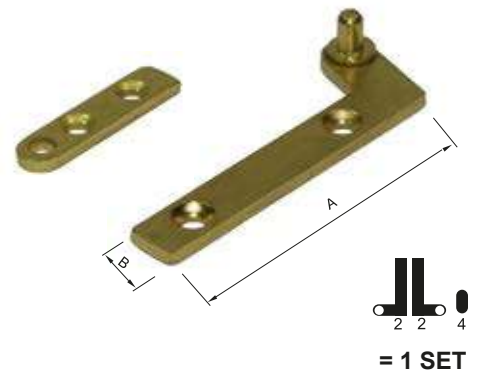

**Perno a falsa squadra c.bussola ottone, tipo stretto**

Art. LE5270B

Pivot with brass sleeve ,narrow type -  
Brassed steel

Pivot type étroit avec douille  
En acier laitonné

Juego pivote con placa de ángulo obtuso  
y buje, tipo estrecho. Acero latonado

Eckzapfenband mit Buchse.  
Schmal Modell

Art.	Misure AxB	Sp.	Var.	Peso(g)	Conf.
LE5270B 02000021	55x8	2,5	Ottonato	49	24 set

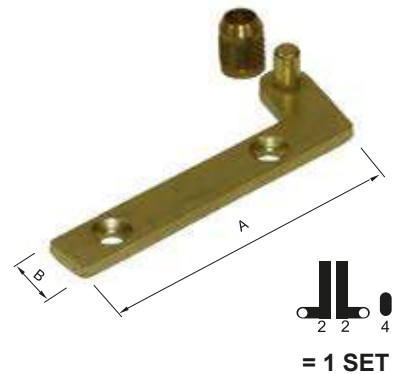

**Perno per ribalta**

Art. LE5286

Pivot -  
Tropicalized steel

Pivot -  
en acier bichromatisé, en acier bruni

Juego pivote con placas por hojas  
basculantes. Acero tropicalizado

Zapfenband für Umkipfung

Art.	Misure AxBxC	Sp.	Var.	Peso(g)	Conf.
LE5286 07700021	69x11x32	3	Zincato nero	32	50
LE5286 07500021	69x11x32	3	Tropicalizzato	32	50
LE5286 00200021	69x11x32	3	Ottonato	32	50

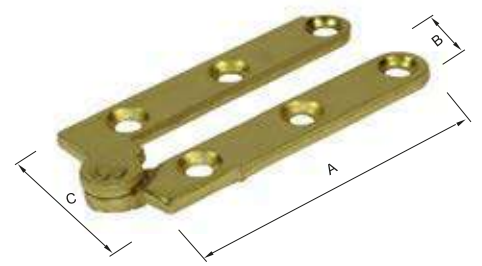

VITERIA E GIUNZIONI - SCREWS AND JOINTS

Art. LE1004F

Piastrina con foro filettato 7/16

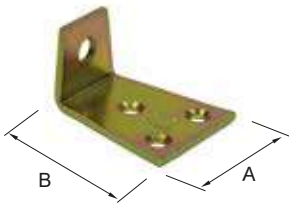

🇬🇧 Plate with threaded hole 7/16 - Tropicalized or Plain steel

🇫🇷 Equerre avec trou fileté 7/16 - En acier et acier bichromatisé

🇪🇸 Placa con agujero fileteado 7/16- Acero y acero tropicalizado

🇩🇪 Platte mit Gewinde

Art.	Misure Ax B	Sp.	Peso(g)	Finitura	Conf.
LE1004F 7500021	33x40	2,5	27	Tropic.	500
LE1004F 0100021	33x40	2,5	27	Grezzo	500

Art. LE1004R

Giunzione con vite taglio cacciavite

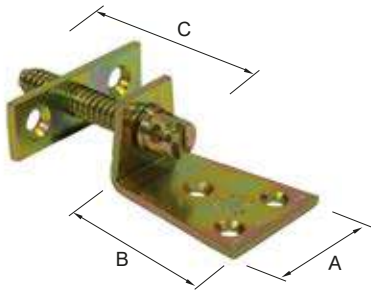

🇬🇧 Fastener with screwdriver cut - Plain steel and Tropicalized steel

🇫🇷 Equerre assemblage avec vis tête fendue - En acier et acier bichromatisé

🇪🇸 Unión con tornillo corte destornillador- Acero y acero tropicalizado

🇩🇪 Schrankverbinder mit Kastenschrauben

Art.	Misure Ax B+C	Sp.	Peso(g)	Finitura	Conf.
LE1004R 7500021	33x40+50	3	60	Tropic.	100
LE1004R 0100021	33x40+50	3	60	Grezzo	100

Art. LE1005R

Giunzione con vite taglio cacciavite

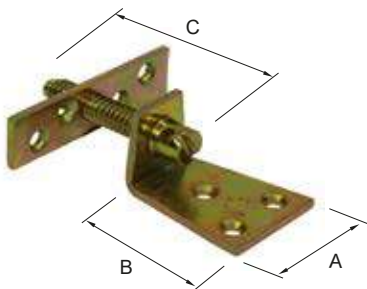

🇬🇧 Fastener with screwdriver cut - Plain steel and Tropicalized steel

🇫🇷 Equerre assemblage avec vis tête fendue - En acier et acier bichromatisé

🇪🇸 Unión con tornillo corte destornillador- Acero y acero tropicalizado

🇩🇪 Schrankverbinder mit Kastenschrauben

Art.	Misure Ax B+C	Sp.	Peso(g)	Finitura	Conf.
LE1005R 7500021	33x40+50	3	63	Tropic.	100
LE1005R 0100021	33x40+50	3	63	Grezzo	100

Art. LE1006R

Giunzione con vite taglio cacciavite

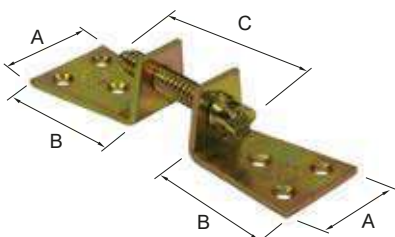

🇬🇧 Fastener with screwdriver cut - Plain steel and Tropicalized steel

🇫🇷 Equerre assemblage avec vis tête fendue - En acier et acier bichromatisé

🇪🇸 Unión con tornillo corte destornillador- Acero y acero tropicalizado

🇩🇪 Schrankverbinder mit Kastenschrauben

Art.	Misure Ax B+B+C	Sp.	Finitura	Peso(g)	Conf.
LE1006R 7500021	33x40+40+50	3	Tropic.	71	100
LE1006R 0100021	33x40+40+50	3	Grezzo	71	100

Giunzione

Art. LE1016

Fastener -  
Tropicalized steel

Equerre assemblage -  
En acier bichromatisé

Unión-  
Acero tropicalizado

Schrankverbinder mit  
Kastenschrauben

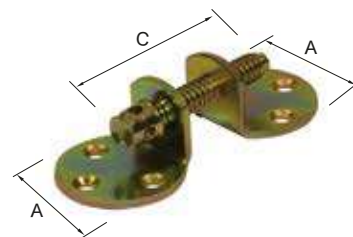

Art.	Misure AxAxB	Sp.	Var.	Peso(g)	Conf.
LE1016 07500021	34+34x50	2,5	Tropicalizzato	61	100

Vite per armadio a testa cilindrica con rondella

Art. LE1088

Screw conic head -  
Plain steel

Vis pour armoire tête  
cylindrique avec cuvette -  
En acier

Tornillo para armario  
con cabeza cilíndrica  
con arandela- Acero

Kastenschraube mit zylindrischem  
Knopf und Scheibe



Art.	A	Var.	Ø testa	Rondella	Peso(g)	Conf.
LE1088 00103021	30	Grezzo	11	Ø17x1,5	12	200
LE1088 00104021	40	Grezzo	11	Ø17x1,5	15	100
LE1088 00105021	50	Grezzo	11	Ø17x1,5	17	100
LE1088 00106021	60	Grezzo	11	Ø17x1,5	22	100
LE1088 00107021	70	Grezzo	11	Ø17x1,5	25	100
LE1088 00108021	80	Grezzo	11	Ø17x1,5	27	100
LE1088 00109021	90	Grezzo	11	Ø17x1,5	30	100
LE1088 00110021	100	Grezzo	11	Ø17x1,5	33	100

Dado corto

Art. LE1090

Short nut  
Plain steel  
Tropicalized steel

Ecrou En acier et  
acier bichromatisé

Tuerca corta-  
Acero y acero tropicalizado

Kurze Mutter aus tropikalisiertem  
Stahl



Art.	Misure AxB	Sp.	Finitura	Peso(g)	Conf.
LE1090 07500021	22x15	3	Tropic.	6	200
LE1090 00100021	22x15	3	Grezzo	6	200

Dado lungo

Art. LE1091

Long nut  
Plain steel  
Tropicalized steel

Ecrou  
En acier et acier bichromatisé

Tuerca larga -  
Acero y acero tropicalizado

Lange Mutter aus tropikalisiertem  
Stahl

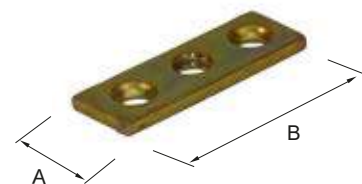

Art.	Misure AxB	Sp.	Finitura	Peso(g)	Conf.
LE1091 07500021	45x15	3	Tropic.	13	200
LE1091 00100021	45x15	3	Grezzo	13	200



Art. LE1171

Piastra tonda



🇬🇧 Cap -  
Brassed steel, nickel plated steel,

🇫🇷 Platine ronde -  
En acier laitonné, en acier nickelé

🇪🇸 Placa redonda -  
Acero tropicalizado - niquelado

🇩🇪 Runde Platte aus vermessingtem  
Stahl oder vernickeltem Stahl

Art.	Misure	Sp.	Var.	Peso(g)	Conf.
LE1171 00200021	Ø44	0,6	Ottonato	9	200
LE1171 08100021	Ø44	0,6	Nichelato	9	200

Art. LE1164

Vite con piastra



🇬🇧 Plain steel screw  
with tropicalized plate

🇫🇷 Palin steel screw  
with tropicalized plate

🇪🇸 Tronillo en acero con palca  
en acero tropicalizado

🇩🇪 Schraube mit Platte

Art.	Var.	Peso(g)	Conf.
LE1164 07500021	Piastra Tropical.	56	100

Art. LE1092

Dado lungo

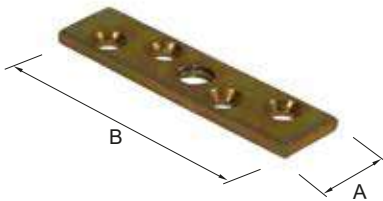

🇬🇧 Long nut 4 holes  
Plain steel  
Tropicalized steel

🇫🇷 Ecrou  
En acier et acier bichromatisé

🇪🇸 Tuerca larga 4 agujeros -  
Acero y acero tropicalizado

🇩🇪 Lange Mutter mit Löchern aus  
tropikalisiertem Stahl

Art.	Misure Ax B	Sp.	Finitura	Peso(g)	Conf.
LE1092 07500021	15x60	3	Tropic.	17	100
LE1092 00100021	15x60	3	Grezzo	17	100

Art. LE1172

Archetto



🇬🇧 Joint for connector -  
Plain steel

🇫🇷 Joint assemblage -  
En acier

🇪🇸 Unión para conector -  
Acero

🇩🇪 Winkelverbinder

Art.	Sp.	Var.	Peso(g)	Conf.
LE1172 00100021	1,8	Grezzo	9	100

## SUPPORTI E LASTRINE - BRACKETS AND PLATES

### Squadretta

Art. LE2012

 Bracket In nickeled steel, bronzed steel

 Equerre de tablette  
En acier nickelé, acier bronzé

 Esquadra de fijación.  
Acero niquelado o bronceado

 Winkelverbinder vernickelter  
oder bronzierter Stahl

Art.	Misure AxBxC	Sp.	Var.	Peso(g)	Conf.
LE2012 08102021	33x20x12	2	Nichelato	9	200
LE2012 08102521	33x25x12	2	Nichelato	10	200
LE2012 00302021	33x20x12	2	Bronzato	9	200
LE2012 00302521	33x25x12	2	Bronzato	10	200

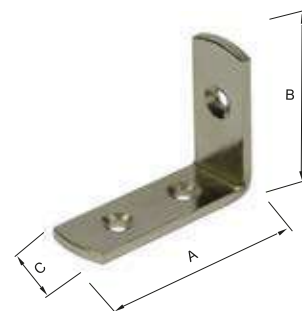

### Lastrina piana

Art. LE2102L

 Mending plate -  
zinc plated steel

 Plaque droite -  
En acier zingué

 Escuadra de fijación.  
Acero cincado

 4 Loch Flachverbinder aus  
verzinktem Stahl

Art.	Misure AxB	Sp.	N.fori	Var.	Peso(g)	Conf.
LE2102L 7604021	40X15	1,8	2	Zincato	7	200
LE2102L 7606021	60X15	1,8	4	Zincato	11	100
LE2102L 7608021	80X15	1,8	4	Zincato	15	100
LE2102L 7610021	100X15	1,8	4	Zincato	19	100
LE2102L 7612021	120X15	1,8	4	Zincato	24	100
LE2102L 7614021	140X15	1,8	4	Zincato	29	100

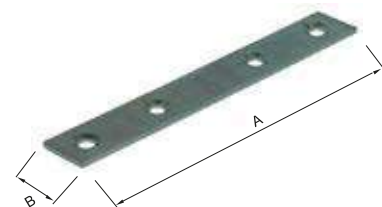

### Squadretta

Art. LE2013

 Bracket  
In nickeled steel, bronzed steel

 Equerre de tablette  
En acier nickelé, acier bronzé

 Esquadra de fijación en  
acero niquelado o bronceado

 Winkelverbinder  
aus bronziertem Stahl

Art.	Misure AxBxC	Sp.	Var.	Peso(g)	Conf.
LE2013 08102521	33x20x15	2	Nichelato	12	200
LE2013 08103021	33x30x15	2	Nichelato	13	200
LE2013 00302521	33x20x15	2	Bronzato	12	200
LE2013 00303021	33x30x15	2	Bronzato	13	200

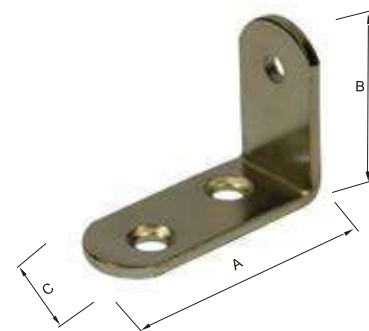

### Lastrina piegata

Art. LE2103L

 Corner braces -  
Zinc plated steel

 Equerre -  
En acier zingué

 Placa de fijación recta.  
Acero galvanizado

 Verstellwinkel aus verzinktem Stahl

Art.	Misure AxBxC	Sp.	N.fori	Var.	Peso(g)	Conf.
LE2103L 7602021	20x20x15	1,8	2	Zincato	7	100
LE2103L 7603021	30x30x15	1,8	4	Zincato	11	100
LE2103L 7604021	40x40x15	1,8	4	Zincato	15	100
LE2103L 7605021	50x50x15	1,8	4	Zincato	20	100
LE2103L 7606021	60x60x15	1,8	4	Zincato	25	100
LE2103L 7607021	70x70x15	1,8	4	Zincato	29	100

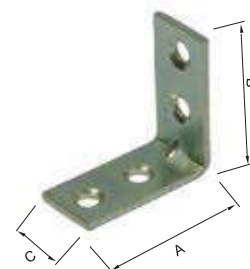

Art. LE2104X

Lastrina piana



Cabinet hook - Zinc plated steel

Plaque d'assemblage - En acier zingué

Pletina de fijación plana con agujero y bocallave. Acero cincado

Flachverbinder aus verzinktem Stahl

Art.	Misure AxB	Sp.	Var.	Peso(g)	Conf.
LE2104X 7606021	60x15	1,5	Zincato	8	300
LE2104X 7608021	80x15	1,5	Zincato	12	100

Art. LE2104Y

Lastrina di congiunzione

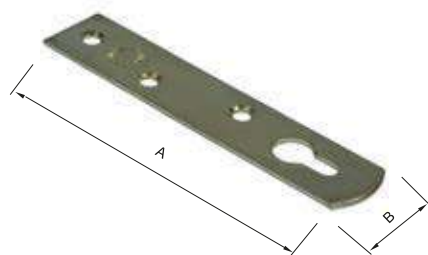

Cabinet hook - Zinc plated steel

Plaque d'assemblage - En acier zingué

Pletina de fijación plana con agujeros y bocallave. Acero cincado

Flachverbinder aus verzinktem Stahl

Art.	Misure AxB	Sp.	Var.	Peso(g)	Conf.
LE2104Y 7606021	60X20	1,5	Zincato	11	300
LE2104Y 7608021	80X20	1,5	Zincato	16	300
LE2104Y 7610021	100X20	1,5	Zincato	21	200
LE2104Y 7612021	120X20	1,5	Zincato	27	200

Art. LE2060

Attaccaglia per quadri

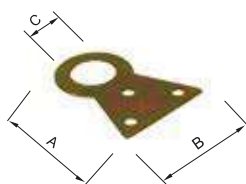

Picture hook tropicalized steel

Attache pour tableau en acier bichromatisé

Gancho por cuadros. Acero tropicalizado

Bilderaufhänger aus verzinktem Stahl

Art.	Misure AxBxC	Sp.	Nr.	Var.	Peso(g)	Conf.
LE2060 07500021	20x19x8	0,9	0	Tropicalizzato	1	500
LE2060 07500121	30x20x10	0,9	1	Tropicalizzato	2	500
LE2060 07500221	37x25x12	0,9	2	Tropicalizzato	3	500
LE2060 07500321	50x37x16	0,9	3	Tropicalizzato	8	500

Art. LE2062

Squadretta

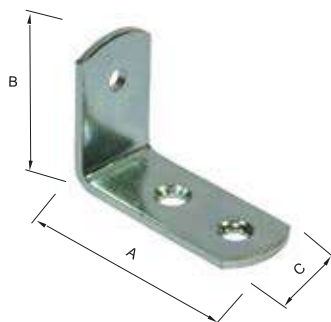

Bracket In nickel-plated steel, bronzed steel

Equerre de tablette En acier nickelé, en acier bronzé

Esquadra de fijación con esquinas redondeadas. Acero niquelado o bronceado

Winkelverbinder aus vernickeltem Stahl, bronziertem Stahl

Art.	Misure AxBxC	Sp.	Var.	Peso(g)	Conf.
LE2062 08101521	30x15x13	1,5	Nichelato	6	200
LE2062 08102021	30x20x13	1,5	Nichelato	7	200
LE2062 08102521	30x25x13	1,5	Nichelato	8	200
LE2062 08103021	30x30x13	1,5	Nichelato	9	200
LE2062 00301521	30x15x13	1,5	Bronzato	6	200
LE2062 00302021	30x20x13	1,5	Bronzato	7	200
LE2062 00302521	30x25x13	1,5	Bronzato	8	200
LE2062 00303021	30x30x13	1,5	Bronzato	9	200

Art. LE2063

Piastrina

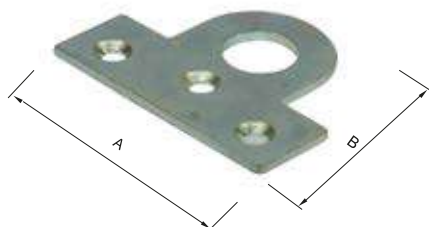

Plate for padlock - Zinc plated steel

Plaque - En acier zingué

Pletina. Acero cincado

Verbindungsplatte für Riegel aus verzinktem Stahl

Art.	Misure AxB	Sp.	Var.	Peso(g)	Conf.
LE2063 07600021	45x35	1,8	Zincato	13	100

**Squadretta** Art. LE2087

 Support -  
Brassed steel, tropicalized steel,  
bronzed steel

 Equerre -  
En acier laitoné, en acier bronzé  
en acier bichromaté,

 Esquadra de fijación  
Acero latonado,  
tropicalizado o bronceado

 Winkelverbinder aus vermessingtem  
Stahl, tropikalisiertem Stahl,  
bronziertem Stahl

Art.	Misure AxBxC	Sp.	Var.	Peso(g)	Conf.
LE2087 00200021	28x22x21	2	Ottonato	14	200
LE2087 07500021	28x22x21	2	Tropicalizzato	14	200
LE2087 00300021	28x22x21	2	Bronzato	14	200
LE2087 08100021	28x22x21	2	Nichelato	14	200

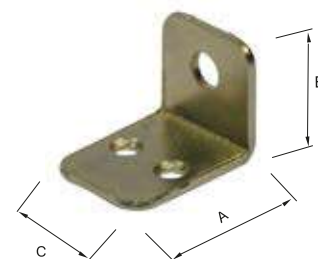

**Squadretta a due asole** Art. LE2088

 Support thickness 2 mm.  
Zinked steel

 Equerre epaisseur 2 mm -  
En acier zinqué

 Esquadra de fijación con  
dos agujeros largos.  
Acero cincado

 Winkelverbinder mit zwei Langlöchern.  
Dicke 2 mm. Aus verzinktem Stahl

Art.	Misure AxBxC	Sp.	Var.	Peso(g)	Conf.
LE2088 07600021	28x22x21	2	Zincato	13	100

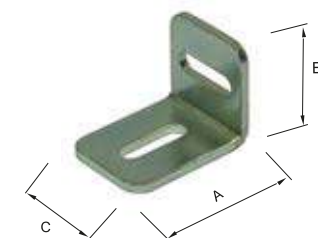

**Supporto** Art. LE2089

 Steel support -  
Nickel plated steel

 Equerre -  
En acier nickelé

 Esquadra de fijación.  
Acero niquelado

 Winkelverbinder mit Lochen  
aus vernickeltem Stahl

Art.	Misure AxBxC	Sp.	Var.	Peso(g)	Conf.
LE2089 S8100021	25x25x21	1,8	Nichelato	13	100

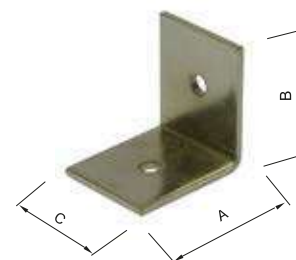

**Lastrina pesante** Art. LE2094

 Cabinet hook -  
Zinc plated steel

 Plaque lourde -  
En acier zingué

 Pletina di fijación  
fuerte. Acero cincado

 Schwerlast Holzverbinder aus  
verzinktem Stahl

Art.	Misure AxB	Sp.	Var.	Peso(g)	Conf.
LE2094 07600021	120x20	2,5	Zincato	40	100

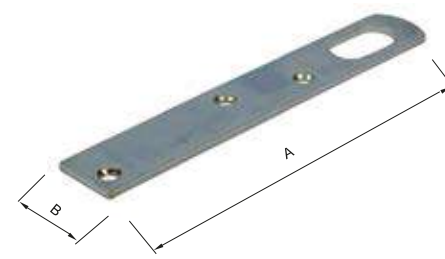

**Lastrina piana** Art. LE2104

 Cabinet hook -  
Plain steel

 Plaque d'assemblage -  
En acier

 Pletina di fijación plana  
recta. Acero cincado

 Flachverbinder aus Rohstahl

Art.	Misure AxB	Sp.	Var.	Peso(g)	Conf.
LE2104 00106021	60x15	1,8	Grezzo	11	200
LE2104 00108021	80x15	1,8	Grezzo	15	200
LE2104 00110021	100x15	1,8	Grezzo	19	200
LE2104 00112021	120x15	1,8	Grezzo	24	200

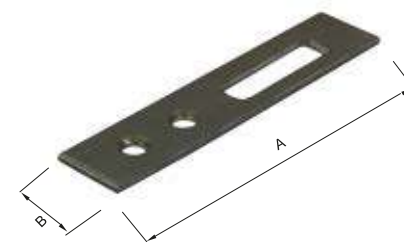

Art. LE2105

Lastrina con finestra

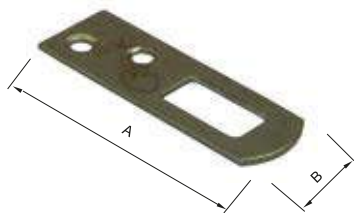

Cabinet hook -  
Zinc plated steel

Plaque d'assemblage -  
En acier zingué

Pletina de fijación plana .  
Acero cincado

Flachverbinder aus  
verzinktem Stahl

Art.	Misure AxB	Sp.	Var.	Peso(g)	Conf.
LE2105 07606021	60x20	1,5	Zincato	10	200
LE2105 07608021	80x20	1,5	Zincato	15	200
LE2105 07610021	100x20	1,5	Zincato	19	200
LE2105 07612021	120x20	1,5	Zincato	24	100

Art. LE2106

Lastrina di congiunzione

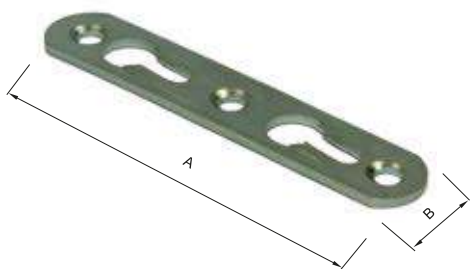

Cabinet hook -  
Zinc plated steel,

Plaque d'assemblage -  
En acier zingué

Pletina de fijación plana  
con esquinas redondeadas.  
Acero cincado

Flachverbinder aus  
verzinktem Stahl

Art.	Misure AxB	Sp.	Var.	Peso(g)	Conf.
LE2106 07605021	50x15	1,8	Zincato	8	100
LE2106 07608021	80x15	1,8	Zincato	13	300

Art. LE2107

Lastrina piegata con fori disassati

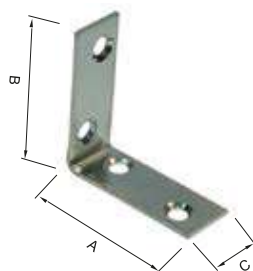

Corner brace -  
In zinc plated steel

Equerre avec trous dexasé  
En acier zingué

Pletina de fijación plana. Acero  
cincado

Verstellwinkel mit außersaxialen  
Löchern aus verzinktem Stahl

Art.	Misure AxBxC	Sp.	Var.	Peso(g)	Conf.
LE2107 07602521	25x25x15	1,8	Zincato	11	100
LE2107 07604021	40x40x15	1,8	Zincato	18	100

Art. LE2108

Lastrina con fori disassati

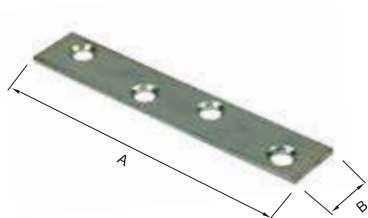

Mending plate -  
Zinc plated steel

Plaque avec trous desaxé -  
En acier zingué

Esquadra de fijación.  
Acero cincado

Flachverbinder mit 4 außersaxialen  
Löchern aus verzinktem Stahl

Art.	Misure AxB	Sp.	Var.	Peso(g)	Conf.
LE2108 07604921	49x15	1,8	Zincato	11	200
LE2108 07608021	80x15	1,8	Zincato	18	200

Art. LE2144A

Angoli piatti

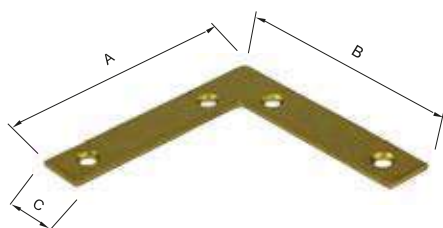

Corner -  
Zinc plated steel, brassed steel

Equerre -  
En acier zingué, en acier laitonné

Escuadra plana. Acero  
latonado o cincado

Flachwinkel aus verzinktem  
Stahl oder vermessingtem  
Stahl

Art.	Misure AxBxC	Sp.	Var.	Peso(g)	Conf.
LE2144A 0203021	30x30x12,5	1,5	Ottonato	6	100
LE2144A 0204021	40x40x12,5	1,5	Ottonato	9	100
LE2144A 0205021	50x50x12,5	1,5	Ottonato	11	100
LE2144A 0206021	60x60x12,5	1,5	Ottonato	14	100
LE2144A 7603021	30x30x12,5	1,5	Zincato	6	200
LE2144A 7604021	40x40x12,5	1,5	Zincato	9	200
LE2144A 7605021	50x50x12,5	1,5	Zincato	11	200
LE2144A 7606021	60x60x12,5	1,5	Zincato	14	200

Angolo piatto per serramenti in legno

Art. LE7144

Flat corner for wood fittings-  
Zinc plated steel

Equerre pour fenêtre -  
En acier zingué

Escuadra plana.  
Acero cincado

Flachwinkel für Holzfenster  
aus verzinktem Stahl

Art.	Misure AxBxC	Sp.	Var.	Peso(g)	Conf.
LE7144 07608021	80x80x20	1,8	Zincato	39	100
LE7144 07610021	100x100x20	1,8	Zincato	52	100
LE7144 07612021	120x120x20	1,8	Zincato	61	50
LE7144 07614021	140x140x20	1,8	Zincato	71	50

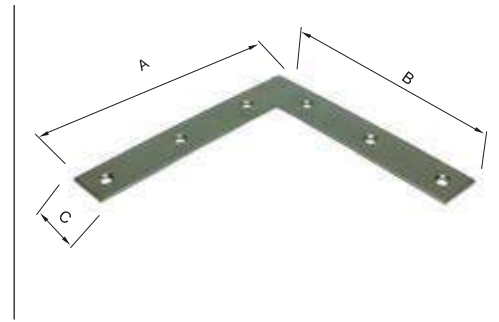

Angolare con bordi stondati

Art. LE2148

Corner 41x41 mm.,  
In brass steel, zinked steel

Equerre 41x41 mm.  
En acier laitoné, en acier zingué

Escuadra plana 41x41  
mm con esquinas redondeadas.  
Acero latonado o cincado

Flachwinkel mit abgerundeten  
Ecken 41x41mm aus vermessingtem  
Stahl oder verzinktem Stahl

Art.	Misure AxBxC	Sp.	Var.	Peso(g)	Conf.
LE2148 00200021	41x41x12,5	1,5	Ottonato	8	100
LE2148 07600021	41x41x12,5	1,5	Zincato	8	100

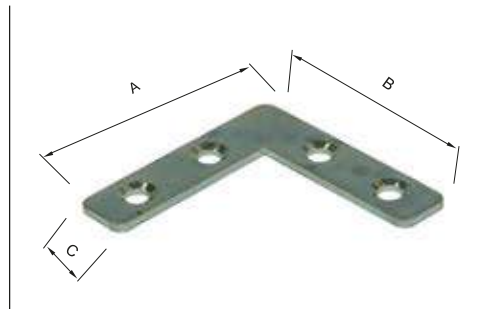

Piastrina

Art. LE2185

Plate 37x37 mm. -  
Zinc plated steel

Plaque 37x37 mm. -  
En acier zingué

Placa de fijación cuadrada  
reforzada 37\*37mm.  
Acero cincado

Quadratisch Flachverbinder  
mit Steg 37X37 aus verzinktem  
Stahl

Art.	Misure AxB	Sp.	Var.	Peso(g)	Conf.
LE2185 07600021	37x37	1	Zincato	10	100

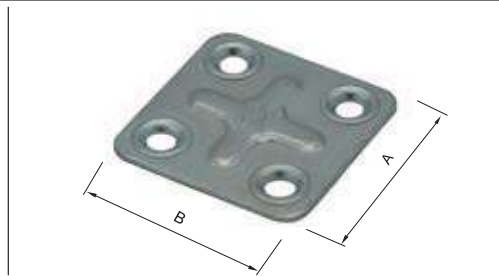

Angolare

Art. LE2185P

Corner plate  
Zinc plated steel

Equerre  
En acier zingué

Angular

Quadratisch Flachverbinder mit  
Steg 37X37 aus verzinktem Stahl

Art.	Misure AxBxC	Sp.	Var.	Peso(g)	Conf.
LE2185P 7600021	37x18,5x18,5	1	Zincato	10	200

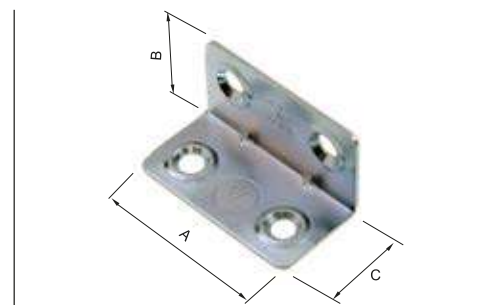

Attaccaglie laterali per cucine

Art. LE2194 - LE2194P

Cabinet hook  
Zinc plated steel

Crochet pour cuisine  
En acier zingué

Colgador lateral de mueble.  
Acero cincado

Seitlicher Möbelaufhänger  
aus verzinktem Stahl

Art.	Misure AxBxCxDxE	Sp.	Var.	Peso(g)	Conf.
LE2194 D7600021	85x60x28x18x31	1,2	Zincato	34	50
LE2194 S7600021	85x60x28x18x31	1,2	Zincato	34	50
LE2194P 76000D1	76x46x25x18x21	1,5	Zincato	26	50
LE2194P 76000S1	76x46x25x18x21	1,5	Zincato	26	50

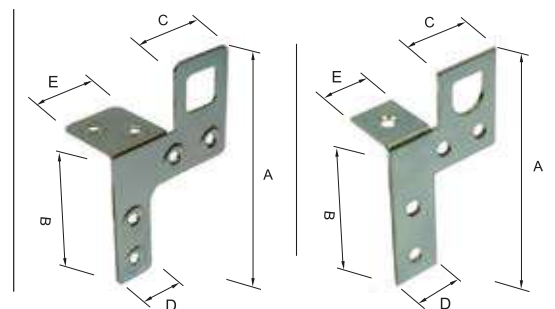

Art. LE2194

Art. LE2194P

Art. LE2195

Attaccaglia centrale per cucine

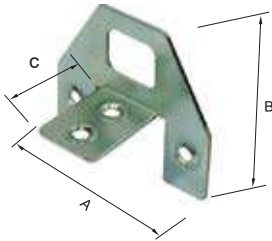

Cabinet hook - zinc plated steel

Crochet central pour cuisine En acier zingué

Colgador central de mueble. Acero cincado

Zentraler Möbelaufhänger aus verzinktem Stahl

Art.	Misure AxBxC	Sp.	Var.	Peso(g)	Conf.
LE2195 07600021	62x55x32	1,5	Zincato	31	50

Art. LE2217

Chiusura da tavolo



Table lock zinc plated steel

Fermeture pour table en acier zingué

Cierre redondo para mesa. Acero cincado

Drehriegel für Tischplatten, aus verzinktem Stahl

Art.	Misure	Sp.	Var.	Peso(g)	Conf.
LE2217 07600021	Ø50	2	Zincato	47	100

Art. LE2227

Gancio

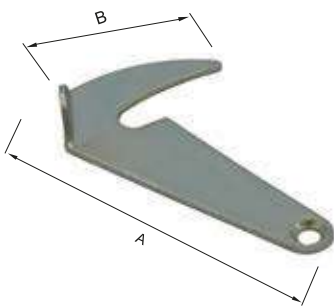

Safety hook zinc plated steel

Crochet en acier zingué

Cierre gancho. Acero cincado

Sicherheitshaken aus verzinktem Stahl

Art.	Misure AxB	Var.	Peso(g)	Conf.
LE2227 07600021	31x58	Zincato	7	200

Art. LE2230

Piastrina

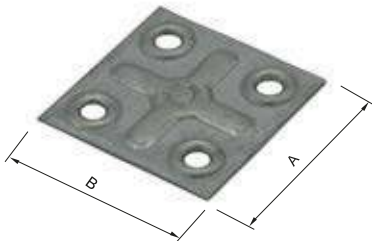

Plate 40x40 mm. Zinc plated steel

Plaque 40x40 mm. En acier zingué

Chapa

Verstellwinkel aus verzinktem Stahl

Art.	Misure AxB	Sp.	Var.	Peso(g)	Conf.
LE2230 07600021	40x40	0,7	Zincato	8	200

Art. LE2232

Piastrina

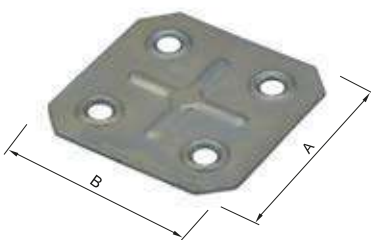

Plate 45x45x1 mm.- Zinc plated steel

Plaque 45x45x1 mm. - En acier zingué

Chapa

Quadratisch Flachverbinder mit Steg 45X45x1 aus verzinktem Stahl

Art.	Misure AxB	Sp.	Var.	Peso(g)	Conf.
LE2232 07600021	45x45	1	Zincato	12	100

## Angolare

Art. LE2235

 Corner plate 45x23x23 mm. -  
Zinked steel

 Angulaire 45x23x23 mm. -  
En acier zingué

 Angular

 Verstellwinkel mit Steg 45x23x23mm  
aus verzinktem Stahl

Art.	Misure AxBxC	Sp.	Var.	Peso(g)	Conf.
LE2235 07600021	45x23x23	1	Zincato	12	100

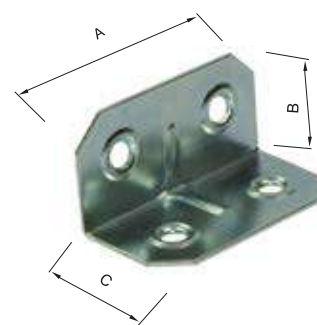

## Piastrina

Art. LE2236

 Plate 50x40x1 mm. -  
Zinc plated steel

 Plaque 50x40x1 mm. -  
En acier zingué

 Chapa

 Flachverbinder mit Sicke 50x40x1  
mm aus verzinktem Stahl

Art.	Misure AxB	Sp.	Var.	Peso(g)	Conf.
LE2236 07600021	50x40	1	Zincato	15	200

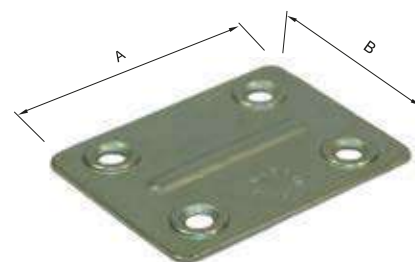



## Angolare

Art. LE2236P

 Corner plate 50x21x21 mm. -  
Zinc plated steel

 Angulaire 50x21 mm. -  
En acier zingué

 Angular 50x12x21 mm.  
Acero cincado

 Flachverbinder mit Sicke 50x40x1  
mm aus verzinktem Stahl

Art.	Misure AxBxC	Sp.	Var.	Peso(g)	Conf.
LE2236P 7600021	50x21x21	1	Zincato	15	100

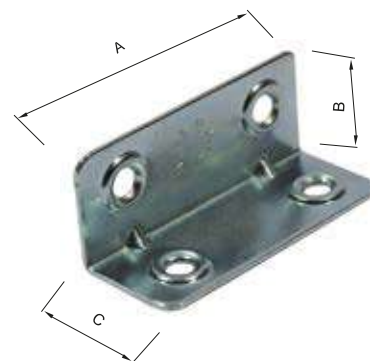



## Piastra con cava per regolazione

Art. LE2237

 Plate 50x40x1,5 mm. -  
Zinked steel

 Plaque 50x40x1,5 mm. -  
En acier zingué

 Placa de fijación regulable  
plana reforzada  
50x40x1,5mm. Acero cincado

 Flachverbinder mit Langlöchern  
und Steg 50x40x1,5mm aus  
verzinktem Stahl

Art.	Misure AxB	Sp.	Var.	Peso(g)	Conf.
LE2237 07600021	50x40	1,5	Zincato	21	100

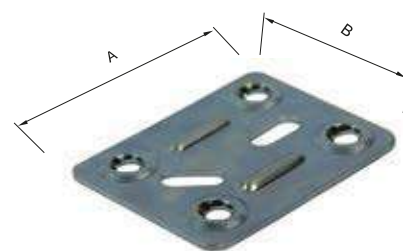

## Angolare

Art. LE2238

 Corner plate 67x21x21 mm. -  
Zinc plated steel

 Angulaire 67x21x21 mm. -  
En acier zingué

 Escuadra de fijación  
reforzada 67x21x21mm.  
Acero cincado

 Winkelverbinder 67x21x21mm  
aus verzinktem Stahl

Art.	Misure AxBxC	Sp.	Var.	Peso(g)	Conf.
LE2238 07600021	67x21x21	1	Zincato	21	100

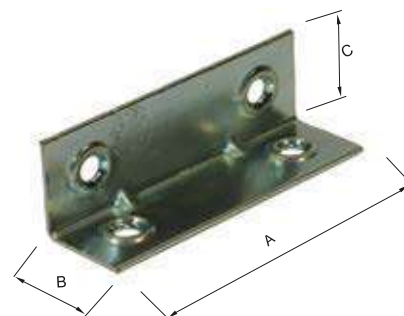



Art. LE2239

Piastrina

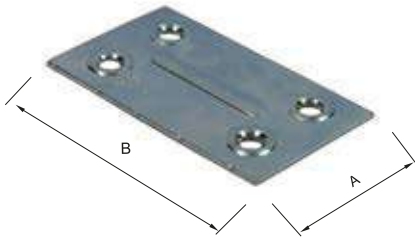

Plate 67x40 mm. - Zinc plated steel

Plaque 67x40 mm. - En acier zingué

Placa de fijación recta reforzada 67x40mm. Acero cincado

Flachverbinder 67x21x21mm mit Steg aus verzinktem Stahl

Art.	Misure AxB	Sp.	Var.	Peso(g)	Conf.
LE2239 07600021	40x67	1	Zincato	20	200

Art. LE2240A

Angolare

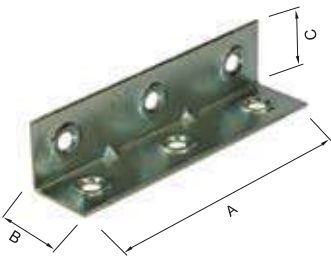

Corner plate 86x21 mm. - Zinc plated steel

Angulaire 86x21 mm. - En acier zingué

Escuadra de fijación reforzada 86x21mm. Acero cincado

Winkelverbinder 86x21mm aus verzinktem Stahl

Art.	Misure AxBxC	Var.	Peso(g)	Conf.
LE2240A 7600021	86x25x25	Zincato	28	100

Art. LE2241A

Piastrina

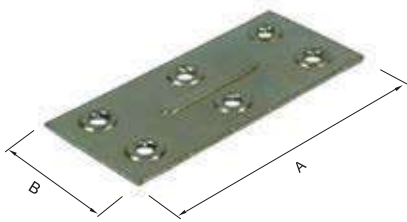

Plate 86x40 mm. - Zinc plated steel

Plaque legere 86x40 mm. - En acier zingué

Placa de fijación recta reforzada 86\*40mm. Acero cincado

Flachverbinder mit Steg 86x40 mm aus verzinktem Stahl

Art.	Misure AxB	Sp.	Var.	Peso(g)	Conf.
LE2241A 7600021	86x40	1,8	Zincato	28	100

Art. LE2242

Angolare

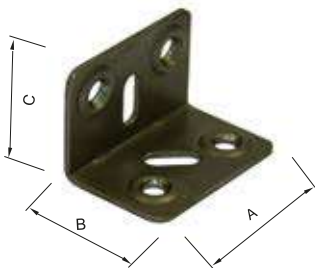

Corner plate 40x25x25x1,5 mm. - In zinked steel

Equerre 40x25x25x1,5 mm. - En acier zingué

Escuadra de fijación 40x25x25x1,5mm. Acero cincado

Winkelverbinder 40x25x25x1.5mm aus verzinktem Stahl

Art.	Misure AxBxC	Sp.	Var.	Peso(g)	Conf.
LE2242 07600021	40x25x25	1,5	Zincato	21	100

Art. LE2247

Attaccaglia regolabile con squadra corta

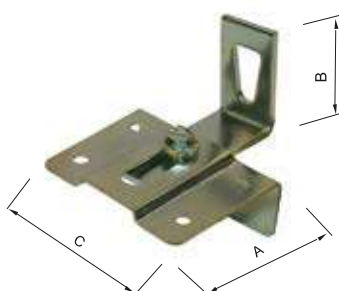

Cabinet hook - Zinc plated steel

Equerre pour suspension - En acier zingué

Estribo regulable con Esquadra larga. Acero cincado

Einstellbarer Möbelaufhänger mit kurzem Winkelverbinder aus verzinktem Stahl

Art.	Misure AxBxC	Var.	Peso(g)	Conf.
LE2247 07600021	55x48x22	Zincato	62	100

## Attaccaglia regolabile con squadra lunga

Art. LE2248

 Cabinet hook -  
Zinc plated steel

 Equerre pour suspension -  
En acier zinqué

 Estribo con squadra corta.  
Acero cincado

 Einstellbarer Möbelaufhänger  
mit langem Winkelverbinder  
aus verzinktem Stahl

Art.	Misure AxBxC	Var.	Peso(g)	Conf.
LE2248 07600021	45x47x55	Zincato	70	100

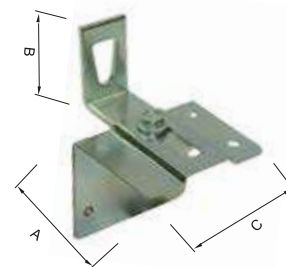

## Squadra per pensili

Art. LE2272

 Cabinet hook -  
zinc plated steel

 Equerre pour cuisine  
En acier zinqué

 Escuadra colgadera para  
muebles suspendidos.  
Acero niquelado

 Schrankaufhänger aus  
vernicheltem Stahl.

Art.	Misure AxBxC	Sp.	Var.	Peso(g)	Conf.
LE2272 07600021	82x36x25	2,5	Zincato	46	100

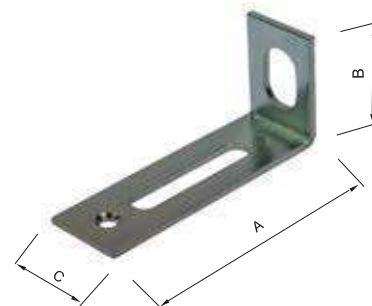

## Attaccaglia quadra per bagno

Art. LE2293

 Squared fastener -  
Zinc plated steel

 Ferrure d'assemblage caree -  
En acier zinqué

 Colgador cuadrado de  
pared. Acero cincado

 Möbelaufhänger aus  
verzinktem Stahl

Art.	Misure AxB	Sp.	Var.	Peso(g)	Conf.
LE2293 07600021	45x35	1,5	Zincato	13	100 set

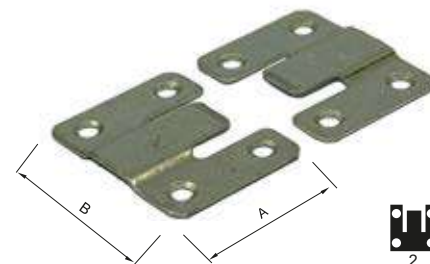

= 1 SET

## Lastrina stondata

Art. LE2319

 Plate -  
Plain steel

 Attache - En acier

 Pletina di fijación plana  
con esquinas redondeadas.  
Acero cincado

 Flachverbinder mit abgerundete  
Ecke

Art.	Misure AxB	Sp.	Var.	Peso(g)	Conf.
LE2319 00100021	80x15	1,8	Grezza	14	200





## Gancio per armadi

Art. LE2330

 Support -  
Nickel plated steel

 Equerre de tablette -  
En acier zinqué

 Escuadra de fijación.  
Acero niquelado

 Verwinkelbinder für  
Schränken aus vernicheltem Stahl

Art.	Misure AxBxC	Sp.	Var.	Peso(g)	Conf.
LE2330 08100021	58x60x33	2	Nichelato	54	100

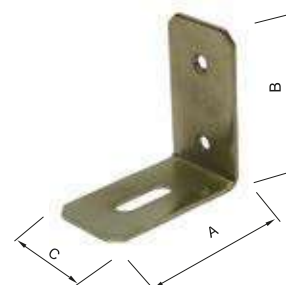

Art. LE2331

Piastra

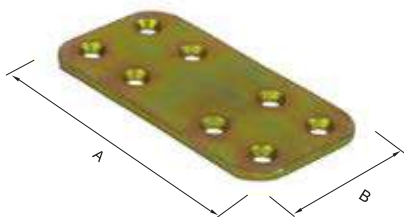

🇬🇧 Plate 60x30 mm. - Tropicalized steel

🇫🇷 Plaque legere 60x30 mm. - En acier bichromatisé

🇪🇸 Placa de fijación con esquinas redondeadas, 60x30mm. Acero tropicalizado

🇩🇪 Flachverbinder 60x30 mm aus tropikalisiertem Stahl

Art.	Misure AxB	Sp.	Var.	Peso(g)	Conf.
LE2331 07500021	60x30	1,8	Tropicalizzato	24	100

Art. LE2332

Angolare



🇬🇧 Corner plate 30x30x1,8 mm. - Tropicalized steel

🇫🇷 Angulaire 30x30x1,8 mm. - En acier bichromatisé

🇪🇸 Escuadra de fijación reforzada 30x30x1,8mm. Acero tropicalizado

🇩🇪 Winkelverbinder mit Steg 30X30X1.8 mm aus tropikalisiertem Stahl

Art.	Misure AxBxC	Sp.	Var.	Peso(g)	Conf.
LE2332 07500021	30x30x30	1,8	Tropicalizzato	24	100

Art. LE2333

Angolare

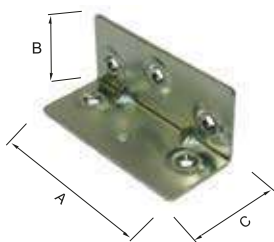

🇬🇧 Corner plate 90x39x37 mm. - Zinc plated steel

🇫🇷 Angulaire 90x39x37 mm. - En acier zingué

🇪🇸 Escuadra de fijación 90x39x37mm. Acero cincado

🇩🇪 Winkelverbinder 90x39x37 mm aus verzinktem Stahl

Art.	Misure AxBxC	Sp.	Var.	Peso(g)	Conf.
LE2333 07600021	90x39x37	2	Zincato	107	50

Art. LE2334 - LE2377

Piastra



🇬🇧 Heavy plate 90x40 mm. - Zinc plated steel

🇫🇷 Plaque de connection 90x40 mm. En acier zingué

🇪🇸 Placa de fijación fuerte con esquinas redondeadas, 90x40mm. Acero cincado

🇩🇪 Flachverbinder 90x40mm aus verzinktem Stahl

Art.	Misure AxB	Sp.	Var.	Peso(g)	Conf.
LE2334 07600021	90x40	2,5	Liscio	59	100
LE2377 07600021	90x40	1,8	Nervato	49	100

Art. LE2335

Angolare pesante

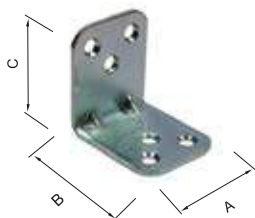

🇬🇧 Heavy angle - Zinc plated steel

🇫🇷 Equerre lourde - En acier zingué

🇪🇸 Escuadra de fijación fuerte. Acero cincado

🇩🇪 Schwerlast-Winkelverbinder aus verzinktem Stahl

Art.	Misure AxBxC	Sp.	Var.	Peso(g)	Conf.
LE2335 07600021	40x48x48	2,5	Zincato	59	100

Art. LE2336

Angolare pesante



🇬🇧 Heavy angle - Zinc plated steel

🇫🇷 Equerre lourde - En acier zingué

🇪🇸 Escuadra de fijación fuerte. Acero cincado

🇩🇪 Schwerlast-Winkelverbinder aus verzinktem Stahl

Art.	Misure AxBxC	Sp.	Var.	Peso(g)	Conf.
LE2336 07600021	26x66x15	2,5	Zincato	59	50

## Cricchetto a sfera

Art. LE2365

Support with strike  
nickel plated steel

Loqueteau a bille avec  
contre plaque - acier nickelé

Trinquete con esfera

Kugel-Ratsche

Art.	Var.	Peso(g)	Conf.
LE2365 08100021	Nichelato	10	200



## Lastrina stondata piana

Art. LE2368

Support -  
Zinc plated steel

Plaque de connection -  
En acier zingué

Pletina de fijación plana con  
esquinas redondeadas. Acero cincado

Abgerundete Flachverbinder  
aus verzinktem Stahl

Art.	Misure AxB	Sp.	Ø.fori	Var.	Peso(g)	Conf.
LE2368 07604021	40X15	1,5	4,5	Zincato	12	300
LE2368 07606021	60X15	1,5	4,5	Zincato	17	100
LE2368 07608021	80X15	1,5	4,5	Zincato	25	100
LE2368 07610021	100X15	1,5	4,5	Zincato	31	100

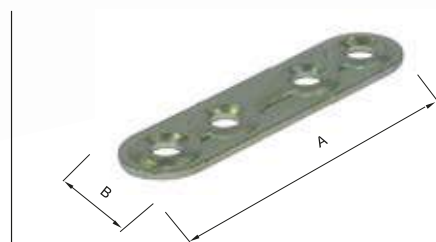

## Lastrina piana

Art. LE2369

Support -  
zinc plated steel

Plaque de connection -  
En acier zingué

Pletina de fijación plana con  
esquinas redondeadas. Acero cincado

Abgerundete Flachverbinder  
aus verzinktem Stahl

Art.	Misure AxB	Sp.	Var.	Peso(g)	Conf.
LE2369 07604021	40X15	1,8	Zincato	16	200
LE2369 07606021	60X15	1,8	Zincato	22	200
LE2369 07608021	80X15	1,8	Zincato	33	200
LE2369 07610021	100X15	1,8	Zincato	45	200
LE2369 07612021	120X15	1,8	Zincato	52	200

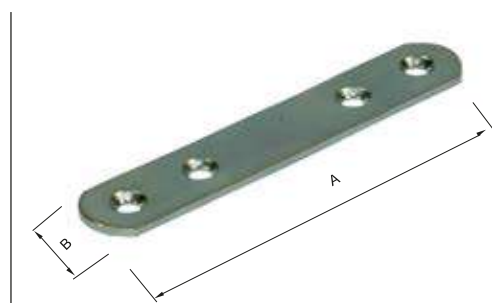

## Lastrina stondata

Art. LE2370

Support -  
zinc plated steel

Plaque de connection -  
En acier zingué

Esquadra de fijación.  
Acero cincado

Abgerundete Flachverbinder  
aus verzinktem Stahl

Art.	Misure AxBxC	Sp.	Var.	Peso(g)	Conf.
LE2370 07602021	20x20x15	1,5	Zincato	12	100
LE2370 07603021	30x30x15	1,5	Zincato	17	100
LE2370 07604021	40x40x15	1,5	Zincato	25	100
LE2370 07605021	50x50x15	1,5	Zincato	31	100

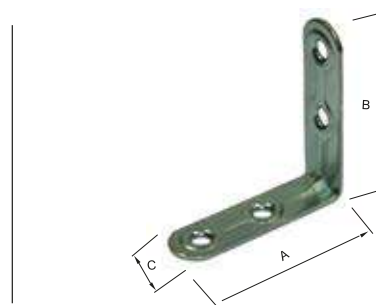

## Lastrina stondata

Art. LE2371

Support -  
Zinc plated steel

Equerre de connection -  
En acier zingué

Esquadra de fijación.  
Acero cincado

Abgerundete Verstellwinkel  
aus verzinktem Stahl

Art.	Misure AxBxC	Sp.	Var.	Peso(g)	Conf.
LE2371 07602021	20x20x15	1,8	Zincato	16	200
LE2371 07603021	30x30x15	1,8	Zincato	22	100
LE2371 07604021	40x40x15	1,8	Zincato	33	150
LE2371 07605021	50x50x15	1,8	Zincato	45	100
LE2371 07606021	60x60x15	1,8	Zincato	56	150

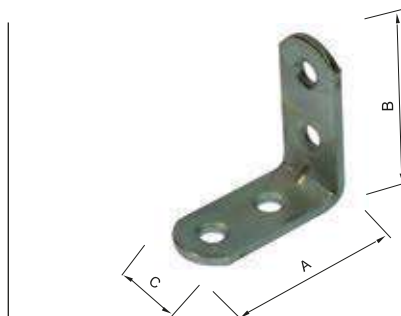

Art. LE2372

Lastrina piegata

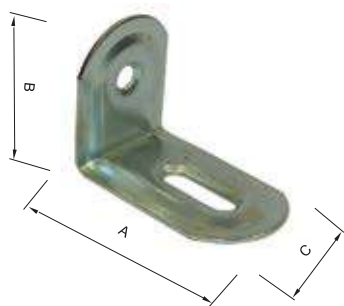

🇬🇧 Bracket - Zinc plated steel

🇫🇷 Equerre de tablette - En acier zingué

🇪🇸 Esquadra de fijación. Acero cincado

🇩🇪 Winkelverbinder aus verzinktem Stahl

Art.	Misure AxBxC	Sp.	Var.	Peso(g)	Conf.
LE2372 07600021	38x28x23	1	Zincato	20	200

Art. LE2375

Lastrina piegata

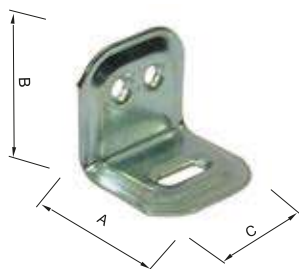

🇬🇧 Support 30x28x28 mm. - Zinc plated steel

🇫🇷 Equerre 30x28x28 mm. - En acier zingué

🇪🇸 Esquadra de fijación. Acero cincado

🇩🇪 Winkelverbinder aus verzinktem Stahl 30X26X28 mm

Art.	Misure AxBxC	Sp.	Var.	Peso(g)	Conf.
LE2375 07600021	228x28x30	1	Zincato	10	200

Art. LE2378

Angolare nervato

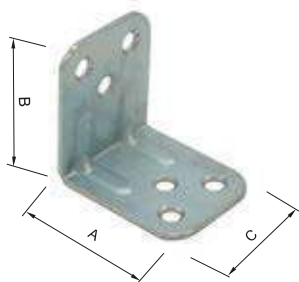

🇬🇧 Corner bracket 48x48x1,8 mm, width 40 mm. In zinc plated steel

🇫🇷 Equerre 48x48x1,8 mm., largeur 40 mm. En acier zingué

🇪🇸 Placa de fijación reforzada fuerte con esquinas redondeadas, 48x48x1,8mm. Acero cincado

🇩🇪 Winkelverbinder mit Rippen 48X48X1,8 mm aus verzinktem Stahl

Art.	Misure AxBxC	Sp.	Var.	Peso(g)	Conf.
LE2378 07600021	48x48x40	1,8	Zincato	49	200

Art. LE2396

Squadretta con asola orizzontale



🇬🇧 Support - Brass steel, nickel plated steel bronzed steel

🇫🇷 Equerre de tablette - En acier laitonné en acier nickelé, en acier bronzé

🇪🇸 Esquadra con agujero largo horizontal. Acero latonado, tropicalizado o bronceado

🇩🇪 Winkelverbinder mit horizontalen Langloch aus vermessingtem Stahl, vernickeltem Stahl, bronziertem Stahl

Art.	Misure AxBxC	Sp.	Var.	Peso(g)	Conf.
LE2396 00200021	28x22x21	2	Otonato	13	200
LE2396 08100021	28x22x21	2	Nichelato	13	200
LE2396 00300021	28x22x21	2	Bronzato	13	200

Art. LE2396A

Squadretta con asola verticale

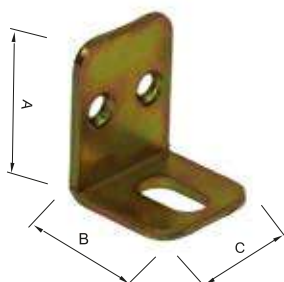

🇬🇧 Bracket - Brass steel, nickel plated steel Zinked steel

🇫🇷 Equerre de tablette - En acier zingué En acier laitonné en acier nickelé,

🇪🇸 Esquadra de fijación con agujero largo vertical. Acero cincado - Acero latonado, tropicalizado

🇩🇪 Winkelverbinder mit vertikalen Langloch aus verzinktem Stahl

Art.	Misure AxBxC	Sp.	Var.	Peso(g)	Conf.
LE2396A 7600021	28x22x21	2	Zincato	14	100
LE2396A 0200021	28x22x21	2	Otonato	14	100
LE2396A 8100021	28x22x21	2	Nichelato	14	100

Attaccaglia per barra squadra corta

Art. LE2722

Cabinet hook  
Zinc plated steel

Equerre pour suspension  
En acier zingué

Estribo regulable con esquadra corta. Acero cincado

Einstellbarer Möbelaufhänger mit kurzem Winkelverbinder aus verzinktem Stahl

Art.	Misure AxBxC	Var.	Peso(g)	Conf.
LE2722 07600021	45+22x55	Zincato	55	100

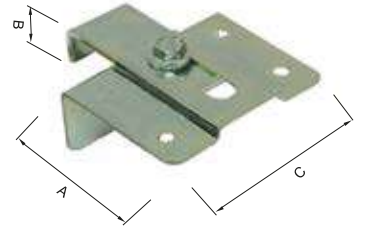

Attaccaglia per barra squadra lunga

Art. LE2723

Cabinet hook  
Zinc plated steel

Equerre pour suspension  
En acier zingué

Estribo de pared regulable con esquadra larga. Acero cincado

Einstellbarer Möbelaufhänger mit langem Winkelverbinder aus verzinktem Stahl

Art.	Misure AxBxC	Var.	Peso(g)	Conf.
LE2723 07600021	45x47x55	Zincato	65	100

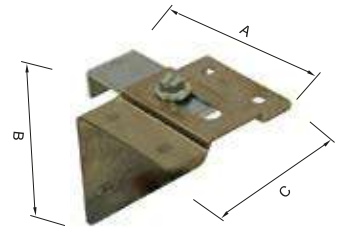

Piastra di giunzione ad angolo

Art. LE2910

Corner plate -  
In zinc plated steel

Support angulaire de jonction -  
En acier zingué

Pletina de fijación plana.  
Acero cincado

Verstellwinkel aus verzinktem Stahl

Art.	Misure AxBxC	Sp.	Var.	Peso(g)	Conf.
LE2910 07602021	20x20x30	1,8	Zincato	16	100
LE2910 07603021	30x30x30	1,8	Zincato	23	50
LE2910 07604021	40x40x30	1,8	Zincato	31	50
LE2910 07605021	50x50x30	1,8	Zincato	40	50
LE2910 07606021	60x60x30	1,8	Zincato	51	50

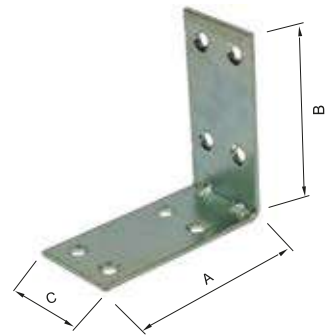

Piastra diritta di giunzione

Art. LE2911

Plate -  
Zinc plated steel

Plaque d'assemblage -  
En acier zingué

Placa de fijación recta.  
Acero galvanizado

Flach Lochverbinder aus verzinktem Stahl

Art.	Misure AxB	Sp.	Var.	Peso(g)	Conf.
LE2911 07604021	40X30	1,8	Zincato	16	50
LE2911 07606021	60X30	1,8	Zincato	23	50
LE2911 07608021	80X30	1,8	Zincato	31	50
LE2911 07610021	100X30	1,8	Zincato	40	50
LE2911 07612021	120X30	1,8	Zincato	51	50

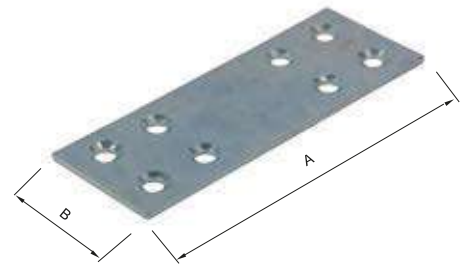

Piastra multifori

Art. LE2950

Plate multi-holes  
Tropicalized steel

Plate avec trous  
En acier bichromatisé

Placa multi-agujeros  
Acero tropicalizado

Flachverbinder aus  
tropikalisiertem Stahl

Art.	Misure AxB	Sp.	Peso(g)	Conf.	**=75 Tropicalizzato	**=76 Zincato
LE2950 0**08021	80x50	2,5	73	50		
LE2950 0**12021	120x50	2,5	110	50		
LE2950 0**16021	160x50	2,5	152	25		
LE2950 0**20021	200x50	2,5	187	25		



Art. LE2951

Angolare multifori

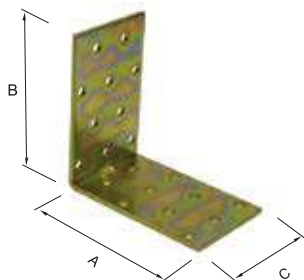

Corner brace multi-holes  
Tropicalized steel

Equerre avec trous  
En acier bichromatisé

Angular multi-agujeros  
Acero tropicalizado

Winkelverbinder aus  
tropicalisiertem Stahl

Art.	MisureAxBxC	Sp.	Var.	Peso(g)	Conf.
LE2951 07504021	40x40 x50	2,5	Tropicalizzato	75	50
LE2951 07506021	60x60 x50	2,5	Tropicalizzato	113	50
LE2951 07508021	80x80 x50	2,5	Tropicalizzato	151	25
LE2951 07510021	100x100 x50	2,5	Tropicalizzato	187	25

Art. LE2960

Piastra multifori

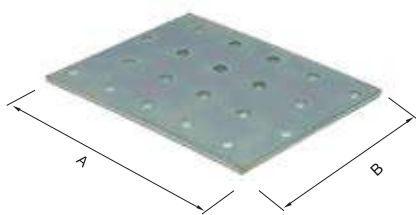

Plate multi-holes  
Tropicalized steel

Plate avec trous  
En acier bichromatisé

Placa multi-agujeros  
Acero tropicalizado

Flachverbinder mit Löchern  
aus tropicalisiertem Stahl

Art.	MisureAxB	Sp.	Peso(g)	Conf.	**=76 Zincato	**=75 Tropicalizzato
LE2960 0** 08021	80x100	2,5	150	25		
LE2960 0** 12021	120x100	2,5	218	25		
LE2960 0** 16021	160x100	2,5	298	20		
LE2960 0** 20021	200x100	2,5	370	20		

Art. LE2961

Angolare multifori

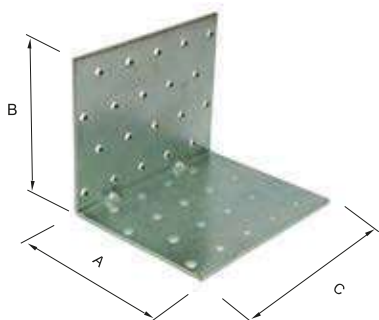

Corner brace multi-holes  
Tropicalized steel

Equerre avec trous  
En acier bichromatisé

Angular multi-agujeros  
Acero tropicalizado

Winkelverbinder aus  
tropicalisiertem Stahl

Art.	MisureAxBxC	Sp.	Peso(g)	Conf.	**=76 Zincato	**=75 Tropicalizzato
LE296 10** 04021	40x40x100	2,5	154	25		
LE296 10** 06021	60x60x100	2,5	223	25		
LE296 10** 08021	80x80x100	2,5	302	20		
LE296 10** 10021	100x100x100	2,5	373	20		

Art. LE2962

Angolare multifori 135°

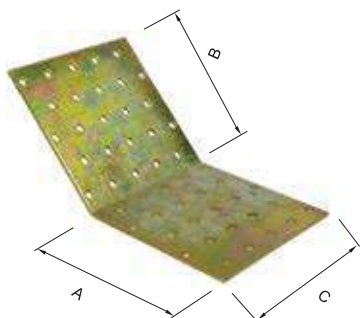

Corner brace 135° multi-holes  
Tropicalized steel

Equerre 135° avec trous  
En acier bichromatisé.

Angular multi-agujeros 135°  
Acero tropicalizado

Winkelverbinder 135° mit Löchern  
aus Tropfenfestem Stahl

Art.	MisureAxBxC	Sp.	Var.	Peso(g)	Conf.
LE2962 07510021	100x100x100	2,5	Tropicalizzato	372	20

Art. LE2970

Piastra multifori

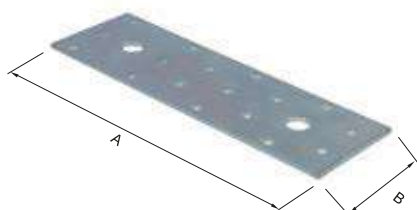

Plate multi-holes  
Tropicalized steel

Plate avec trous  
En acier bichromatisé

Placa multi-agujeros  
Acero tropicalizado

Flachverbinder mit Löchern aus  
Tropfenfestem Stahl

Art.	MisureAxB	Sp.	Peso(g)	Conf.	**=76 Zincato	**=75 Tropicalizzato
LE2970 0** 12021	120x50	2,5	107	50		
LE2970 0** 16021	160x50	2,5	147	25		

## Angolare multifori

Art. LE2971

 Corner brace multi-holes  
Tropicalized steel

 Equerre avec trous  
En acier bichromatisé

 Angular multi-agujeros  
Acero tropicalizado

 Winkelverbinder mit Löchern aus  
Tropenfestem Stahl

Art.	Misure AxBxC	Sp.	Peso(g)	Conf.	**=76 Zincato	**=75 Tropicalizzato
LE2971 0 **06021	60x60x50	2,5	110	50		
LE2971 0 **08021	80x80x50	2,5	148	50		

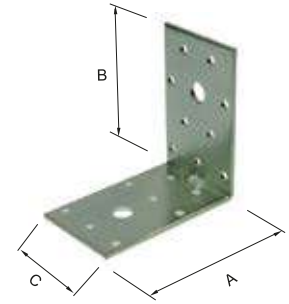



## Angolare multifori 135°

Art. LE2972

 Corner brace 135° multi-holes  
Tropicalized steel

 Equerre 135° avec trous  
En acier bichromatisé

 Angular multi-agujeros 135°  
Acero tropicalizado

 Winkelverbinder 135° mit Löchern  
aus Tropenfestem Stahl

Art.	Misure AxBxC	Sp.	Var.	Peso(g)	Conf.
LE2972 07506021	60x60x50	2,5	Tropicalizzato	103	50
LE2972 07508021	80x80x50	2,5	Tropicalizzato	148	25

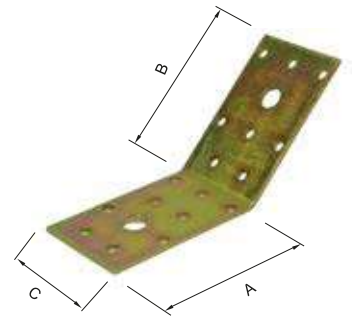



Cod. Articolo	N° Pagina	Cod. Articolo	N° Pagina	Cod. Articolo	N° Pagina	Cod. Articolo	N° Pagina
0001	162	1	96	78	97	127	120
0002	162	2	102	79	97	128	80-142
0003	162	3	103	80	98	129	115
0004	162	4	104	81	98	130	22-23
0005	162	5	102	82	98	131	22-23
0006	162	6	103	83/2	172	132	22-23
0007	162	7	104	86	189	133	140-141
0010	162	8	102	90	101	135	116
0011	162	9	103	91	100	136	124
0012	162	10	96	92	98	137	22-23
0013	162	11	94	93	100	137	125
0016	162	12	94	94	100	138	125
0017	162	13	97	95	99	139	126
0018	162	13/S	96	96	99	140	24
0044	163	18	95	97	99	141	24
0045	163	19	95	98	99	142	24
0046	163	20	95	99	26	143	47
0047	163	24	104	100	25	144	47
0048	163	25	102	101	25	145	48
0048F	163	26	94	102	25	146	49
0049	163	27	94	104	30	147	24
0050	163	28	95	105	30	147	121
0051	163	29	95	106	25	147/1	121
0052	163	30	103	107	25	147/2	121
0053	143	31	105	108.1	30	147/3	121
0054	143	32	105	110	16-17	147/4	121
0055	143	50	96 -174	111	16-17-233	147/5	121
0056	143	51	96	112	16-17	148	26
0503	161	52	97	113	131	149	159
0504	161	52/S	96-190	114	116	150	26
0506	159	52/SC	97	115	114	151	31
0507	167	54	97	116	137	152	28
0601	160	55	98	117	16-17	153	28
0602	160	56	98	120	20-21	153/4	28-58
0603	160	57	98	121	20-21	153/5	58
0604	160	58	105	122	20-21	153/5	28
0606	163	75	96	123	80-142	153/6	28
0607	163	76	96	124	88-192	153/7	28
0608	160	77	97	125	88-192	154	27
0609	160	77/S	96	126	130	155	27
0610	162	77/SC	97	127	20-21	156	29

Cod. Articolo	N° Pagina	Cod. Articolo	N° Pagina	Cod. Articolo	N° Pagina	Cod. Articolo	N° Pagina
156/1	29	202	85	281	89	402	230
157	27	204	85	297	87	403	233
159	45	204/1	85	298	87	404	231
160	29	207	111	299	87	405	232
161	29	208	111	300	72	406	231
162	58	211	117	301	72	407	231
163/40	48	212	117	302	73	408	232
163/40.4	48	214	114	303	73	409	232
164	35	215	137	304	73	410	232
164/A	46	216	115	305	73	412	231
164/P	35	217	118	306	72	413	233
165	34	218	115	307	72	414	233
166	35	219	114	308	72	416	233
166/A	46	220	18-19	309	72	420	230
166/P	35	221	18-19	310	72	421	230
170	34	222	18-19	311	72	459	105
174	44	223	115	312	73	700	221
175	116	227	18-19	313	73	705	112
176	117	250	49	314	73	706	112
177	116	252	82	315	73	707	112
178	110	253	51	316	74	708	113
179	124	254	166	317	74	713	113
180	124	255	50	318	76	714	110
182	125	256	83	319	76	715	109
183	50	257	83	320	77-142	715/D	109
184	50	258	81	321	77-142	716	131
185	126	259	81	330	77-142	717	131
186	126	260	81	350	74	800	91
187	127	261	84	351	74	827	44
188	127	262	84	352	74	840	66
189	127	263	82	353	75	841	66
190	128	264	82	354	75	842	66
191	128	265	50	355	75	843	55
192	128	266	83	356	75	844	57
193	129	267	83	357	75	845	57
194	120	268	84	358	75	846	58
195	120	269	84	359	75	847/1	60
197	119	270	89	360	75	847/2	60
198/1	86	271	89	361	74	848	56
198/2	86	272	80	400	230	850	55
198/3	86	280	89	401	230	850/4	55

Cod. Articolo	N° Pagina	Cod. Articolo	N° Pagina	Cod. Articolo	N° Pagina	Cod. Articolo	N° Pagina
851	56	914	136	2010/CP	150	3083	172
852	56	915	136	2101/CP	150	3084	175
852/4	56	916	136	2102/CP	150	3085	173
853/1	57	917	136	2151/CP	150	3088	173
854	57	918	137	2152/CP	150	3089	191
855/1	59	919	137	2200	159	3090	14-68-178
855/2	59	920	137	2201/CP	151	3091	14-179
855/3	59	920	42	2202/CP	151	3094	15-178
855/4	60	921	42	2301/CP	151	3095	15-179
856/1	68	922	42	2302/CP	151	3096	15-178
856/2	68	923	43	2351/CP	151	3097	15-179
857	54	924	43	2352/CP	151	3100	188
858	69	926	47	2501/CP	152	3100/P	130
859	54	1001	156	2502/CP	152	3103	188
860	69	1002	156	2551/CP	152	3117	207
861	69	1010	156	2552/CP	152	3118	207
875	41	1101	156	3002	177	3127	208
876	40	1102	156	3003	175	3129	207
885	46	1151	156	3004	176	3183	172
886	48	1152	156	3005	101-196	3186	170
887	49	1153	28	3006	172	3186/ST	170
888	46	1156	29	3009	174	3187	171
889	49	1198	86	3010	176	3188	170
890	45	1201	157	3011	177	3190/1	190
891	45	1202	157	3012	177	3190/2	189
892	45	1301	157	3013	177	3191	206
893	45	1302	157	3014	173	3192	206
894	47	1351	157	3015	176	3193	206
895	34	1352	157	3016	191	3194	205
897	138	1355	75	3017	208	3195	205
898	138	1360	75	3018	208	3196	205
899	139	1362	76	3019	208	3197	191
901	139	1364	76	3021	197	3198	197
902	139	1365	76	3022	195	3199/1	199
903	139	1367	76	3023	197	3199/2	199
904	139	1501	158	3024	191	3199/3	191
905	137	1502	158	3026	14-178	3303	188
910	135	1551	158	3050	194	3304	187
911	135	1552	158	3051	194	3305	187
912	135	2001/CP	150	3052	194	3306	187
913	135	2002/CP	150	3053	195	3403	188

Cod. Articolo	N° Pagina	Cod. Articolo	N° Pagina	Cod. Articolo	N° Pagina	Cod. Articolo	N° Pagina
3553	88-192	3983	203	5000	166	AG20	39
3600	180	3984	201	5001	165	AG20G	39
3601	180	3985	202	5002	165	AG20/S	37
3602	180	3986	202	5011	165	AG20/I	37
3650	180	3987	202	5012	165	AG20G/S	37
3651	181	3988/1	204	5100	165	AG21	38
3652	181	3988/2	204	5110	165	AG22	38
3653	181	3988/3	204	5147	144	AG23	38
3700	182	3988/4	204	5148	144	LE1004F	254
3701	182	3990	198	5149	145	LE1004R	254
3702	182	3991	198	5150	144	LE1005R	254
3750	129-182	3992	26	5151	144	LE1006R	254
3751	183	4001/CP	153	5152	145	LE1016	255
3752	183	4002/CP	153	5153	145	LE1088	255
3753	183	4010/CP	153	5154	145	LE1090	255
3800	184	4101/CE	148	5200	166	LE1091	255
3801	184	4101/CP	153	5203	144	LE1092	256
3850	130-184	4102/CE	148	5204	145	LE1164	256
3851	185	4102/CP	153	5210	166	LE1171	256
3852	185	4151/CE	148	5301	164	LE1172	256
3901	189	4151/CP	153	5302	164	LE2012	257
3903	181	4152/CE	148	5311	164	LE2013	257
3904	180	4152/CP	153	5312	164	LE2060	258
3906	186	4201/CP	154	5400	164	LE2062	258
3907	186	4202/CP	154	5410	164	LE2063	258
3908	186	4301/CE	148	5500	165	LE2087	259
3910	174	4301/CP	154	5510	165	LE2088	259
3920	175	4302/CE	148	5600	164	LE2089	259
3921	193	4302/CP	154	5610	164	LE2094	259
3922	193	4351/CE	149	6002/CP	152	LE2102L	257
3923	200	4351/CP	154	6003/CP	155	LE2103L	257
3924	200	4352/CE	149	6005	167	LE2104	259
3925	193	4352/CP	154	6007	167	LE2104X	258
3926	193	4501/CE	149	6010	161	LE2104Y	258
3952	181	4501/CP	155	6011	161	LE2105	260
3975	196	4502/CE	149	6500.1	224	LE2106	260
3976	195	4502/CP	155	6500.2	224	LE2107	260
3977	101-196	4551/CE	149	6500.3	224	LE2108	260
3980	201	4551/CP	155	6500.4	225	LE2144A	260
3981	201	4552/CE	149	6500.5	225	LE2148	261
3982	203	4552/CP	155	6600	199	LE2185	261

Cod. Articolo	N° Pagina	Cod. Articolo	N° Pagina	Cod. Articolo	N° Pagina	Cod. Articolo	N° Pagina
LE2185P	261	LE2378	268	LE4316	239	LE8351	245
LE2194	261	LE2396	268	LE4317	239	LE8352	245
LE2194P	261	LE2396A	268	LE4332	239	LE8355	242
LE2195	262	LE2397	241	LE4920	239	LE8360	242
LE2209	240	LE2398	241	LE4950	239		
LE2217	262	LE2722	269	LE5108	250		
LE2219	240	LE2723	269	LE5111	250		
LE2220	240	LE2910	269	LE5112	250		
LE2222	241	LE2911	269	LE5113	250		
LE2227	262	LE2950	269	LE5115	250		
LE2230	262	LE2951	270	LE5116	251		
LE2232	262	LE2960	270	LE5116B	251		
LE2235	263	LE2961	270	LE5118	251		
LE2236	263	LE2962	270	LE5119	251		
LE2236P	263	LE2970	270	LE5175	251		
LE2237	263	LE2971	271	LE5176	252		
LE2238	263	LE2972	271	LE5177	252		
LE2239	264	LE3068	248	LE5214	252		
LE2240A	264	LE3095	248	LE5215	252		
LE2241A	264	LE3098	248	LE5215B	252		
LE2242	264	LE3098A	248	LE5266	253		
LE2247	264	LE3099	248	LE5270	253		
LE2248	265	LE3110	249	LE5270B	253		
LE2272	265	LE3361	249	LE5286	253		
LE2293	265	LE3363	249	LE6131	246		
LE2319	265	LE3365	249	LE6132	246		
LE2330	265	LE3366	249	LE6133	246		
LE2331	266	LE4120	236	LE6135	246		
LE2332	266	LE4120A	236	LE6157	247		
LE2333	266	LE4121	236	LE6159A	247		
LE2334	266	LE4121F	236	LE7144	261		
LE2335	266	LE4124	237	LE8242	242		
LE2336	266	LE4125	237	LE8243	242		
LE2365	267	LE4125P	237	LE8244	243		
LE2368	267	LE4252	237	LE8288	243		
LE2369	267	LE4253	237	LE8289	244		
LE2370	267	LE4253D	238	LE8301	244		
LE2371	267	LE4254	238	LE8328	243		
LE2372	268	LE4277	238	LE8331	243		
LE2375	268	LE4310	238	LE8340	245		
LE2377	266	LE4312	238	LE8350	244		



[x1000]	Euro per 1000 pezzi	Euro per 1000 pieces	Euro par 1000 pièces	Euro por 1000 unidades	Euro für 1000 Stück
	Euro per metro lineare	Euro per linear meter	Euro par mètre	Euro por metro	Euro pro laufendem Meter
Apertura interna	Apertura interna	Internal opening	Ouverture interne	Abertura interior	Innere Öffnung
Chiave	Chiave	Key	Clef	Llave	Schlüssel
Pomolo	Pomolo	Button	Bouton	Pomo	Knopf
Art.	Codice articolo	Article code	Code article	Código artículo	Artikelnummer
Base	Base	Basis	Base	Base	Basis
Cuscinetto	Cuscinetto a sfera	Ball bearing	Roulement à billes	Cojinete a bolas	kugelgelagerten
Cerniera	Cerniera	Hinge	Charnière	Chamela	Scharnier
Con battuta	Con battuta	Shoulder hinge	Charnière avec feuillure	Chamela con paliza	mit Anschlag
Piana	Piana	Plain hinge	Charnière plane	Chamela plana	flache
Conf.	Confezione	Packing	Conditionnement	Paquete	Packung
Cursor	Cursor	Slider	Coulisse	Desviador	Cursor
Dritto	Dritto	Straight	Droit	Derecho	gerader
Piegato	Piegato	Bended	Plié	Plegado	gefaltet
Gola	Gola	Groove	Gorge	Canal	Kehle
H	Altezza	Height	Hauteur	Altura	Höhe
Imb.	Imballo	Outer packing	Emballage	Embalaje	Verpackung
Ingombro	Dimensioni scatola	Box dimensions	Dimensions boîte	Dimensión del paquete	Größe der Box
L	Larghezza	Width	Largeur	Ancho	Breite
LF	Leva ferro	Iron lever	Levier en fer	Palanca en hierro	Eisenhebel
LO	Leva ottone	Brass lever	Levier en laiton	Palanca en latón	Hebel aus Messing
Mano	Mano	Hand	Main	Mano	Hand
Dx	Destra	Right	Droite	Derecha	recht
Sx	Sinistra	Left	Gauche	Izquierda	linke
Misura	Misura	Measures	Dimensions	Dimensiones	Maß
Peso [g]	Peso singolo pezzo	Weight single piece	Poids pièce individuelle	Peso de cada unidad	Gewicht eines einzelnen Stücks
Peso max. [Kg]	Peso per 1000 pezzi	Weight per 1000 pieces	Poids par 1000 pcs.	Peso por mil unidades	Gewicht pro 1000 Stück
Peso/m [g x m]	Peso a metro lineare	Weight per linear meter	Poids par mètre	Peso por metro	Gewicht pro laufendem Meter
PF	Perno ferro	Steel pin	Pivot en fer	Pernio en hierro	Bolzen aus Eisen
PO	Perno ottone	Brass pin	Pivot en laiton	Pernio en latón	Bolzen aus Eisen
Port. [Kg.]	Portata in Kg.	Load capacity in Kg.	Capacité en Kg.	Capacidad en Kg.	Tragfähigkeit
R	Rondella	Washer	Rondelle	Arendela	Unterlegscheibe
Scatti	Scatti	Clicks	Déclics	Clicks	Aufnahmen
Var.	Variante	Variant	Variante	Variante	Variation
Acciaio	Acciaio	Steel	Acier	Acero	Stahl
Asola	Asola	Slot	Feinte	Ranura	Knopfloch
Chiave corta	Chiave corta	Short key	Clef courte	Llave corta	Kurzer Schlüssel
Chiave lunga	Chiave lunga	Long key	Clef longue	Llave larga	Langer Schlüssel
Cilindro	Cilindro	Cylinder	Cylindre	Cilindro	Zylinder
Con aste	Con aste	With bars	Avec barres	Con Barras	mit Bügeln
Con cilindro	Con cilindro	With cylinder	Avec cylindre	Con cilindro	mit Zylinder
Corta a pompa	Corta a pompa	Pump Key	Courte avec pompe	Corta con pomba	kurz mit Pumpe
Corta doppia mappa	Corta doppia mappa	Short double-bit	Courte panneton doublé	Corta a doble paletón	Kurz auf doppelte Karte
Esterno	Esterno	External	Externe	Exterior	äußeren
Interno	Interno	Internal	Interne	Interior	Inneren
Lunga doppia mappa	Lunga doppia mappa	Long double-bit	Longue panneton doublé	Larga a doble paletón	lange doppelte Karte
Ottonate	Ottonate	Brass finish	Laiton néés	Latoneado	vermessingtem
Ottone	Ottone	Brass	Laiton	Latón	Messing
Nylon	Nylon	Nylon	Nylon	Nylon	Nylon
S/cil.	Senza cilindro	Without cylinder	Sans cylindre	Sin cilindro	ohne Zylinder
Senza aste	Senza aste	Without bars	Sans barres	Sin barras	ohne Bügeln
Senza cilindro	Senza cilindro	Without cylinder	Sans cylindre	Sin cilindro	ohne Zylinder
Verniciata	Verniciata	Varnished	Verniée	Barnizada	lackiert
Zincata	Zincata	Galvanized	Zinguée	Cincada	galvanisierte
Alluminio	Alluminio	Aluminium	Aluminium	Aluminio	Aluminium
Ferro	Ferro	Iron	Fer	Hierro	Eisen
Bugne	Bugne	Bossages	Bossages	Distanciador	Noppen
Bussola	Bussola	Bush	Douille	Herraje	Kompass
Dado	Dado	Nut	Écrou	Dado	Mutter
Inox	Inox	Inox	Inox	Inox	Inox

- 
-  Tutti i disegni, dati tecnici e tutte le relative specifiche devono intendersi di proprietà della Nova-Ferr srl. Gli utilizzi non espressamente autorizzati saranno perseguiti giudizialmente. La Nova-Ferr srl si avvale del diritto di apportare modifiche e migliorie necessarie senza dare alcun preavviso. La Nova-Ferr srl non può essere ritenuta responsabile per inesattezze e errori tipografici.

Stampato nel mese di Gennaio 2023 in 2000 copie

Catalogo Prodotti **NOVA-FERR srl N° 25**

Realizzato da: Anovaproject

Foto realizzate da: Cristiano Mavar

---

-  *All drawings as well as all relative specifications belong to Nova-Ferr Srl. Legal proceedings against any use, not expressly authorised, will be instituted. Nova-Ferr Srl reserves the right to modify or improve any item when considered necessary, without any prior advice. Nova-Ferr Srl can not be held responsible for typographic mistakes and errors.*

*Printed 2000 copies*

---

-  *Tous les dessins et toutes les spécifications relatives doivent s'entendre de propriété de Nova-Ferr Srl. Les utilisations non expressément autorisées seront poursuivies légalement. Nova-Ferr Srl se réserve le droit d'apporter toutes modifications ou améliorations nécessaires sans aucun préavis. Nova-Ferr Srl ne peut pas être retenue responsable pour toutes méprises et erreurs typographiques.*

*Imprimé 2000 exemplaires*

---

-  *Todos los dibujos y todas la especificaciones relativas son de propiedad exclusiva de Nova-Ferr s.r.l. La utilización de estos datos, sin autorización, será perseguida jurídicamente. Nova-Ferr srl se reserva, en caso de necesidad, el derecho de modificar o cambiar las referencias de los productos en cualquier momento sin previo aviso. Nova-Ferr srl no admitirá responsabilidades por posibles errores de codificación o impresión.*

*Impresas 2000 copias*

---

-  *Alle Entwürfe, technische Daten und Spezifikationen sind das Eigentum von Nova-Ferr Srl angesehen werden. Alle Verwendungen, die nicht ausdrücklich autorisiert wurden, werden gerichtlich verfolgt. Die Nova-Ferr srl nutzt das Recht, die notwendigen Änderungen und Verbesserungen ohne jede Ankündigung vorzunehmen. Die Nova-Ferr srl ist nicht verantwortlich für Ungenauigkeiten und typographische Fehler.*

*2000 Exemplare gedruckt*







**Kassel**<sup>®</sup>

**NOVAGUIDE**<sup>®</sup>

**ARTIK**  
*L'elemento di separazione*

**Sistemi**  
**NF**

Distribuito da:

**NOVA-FERR srl**



10070 Grosso (TO) - Località Vauda 12  
Tel. +39 (0)11 92 68 262 - Fax +39 (0)11 92 60 009  
[www.novaferr.com](http://www.novaferr.com) - [info@novaferr.com](mailto:info@novaferr.com)